

Makita[®]

Catálogo de
ACCESORIOS
2023 / 24



CAMPOMAR
SUMINISTROS, S.L.

www.campomar.com.es

POLIG. LA VEGA
AVD. BURGOS, 57
09240 BRIVIESCA (Burgos)

947591055
info@campomar.com.es
facturacion@campomar.com.es

HISTORIA

Makita se ha convertido en uno de los grandes fabricantes mundiales de herramientas electroportátiles, con 11 plantas de fabricación repartidas por todo el mundo y un gran número de subsidiarias. Con una selección de más de 700 modelos de calidad superior y fabricados con la tecnología más avanzada, Makita ofrece la más amplia gama de herramientas eléctricas.

En Marzo de 1915, Mosaburo Makita, funda MAKITA ELECTRIC WORKS en la ciudad de Nagoya, una tienda especializada en la venta y reparación de motores eléctricos y transformadores.

En 1989 se funda Makita España, S.A. y en noviembre de 1991, cambia su nombre a Makita, S.A.

A través de los años la empresa inicial sufre varias transformaciones:

1915 Se funda Makita Electric Works en la ciudad de Nagoya. Comenzó vendiendo y reparando equipamiento eléctrico, motores, y transformadores.

1958 Se inició la comercialización de los cepillos eléctricos, el primer producto en Japón.



1969 Taladro a batería 6500D (la primera herramienta a batería).



1978 Se lanza el modelo 6010D taladro a batería (primera herramienta a batería de Ni-Cd).



1981 Se lanza el modelo AN5000 clavadora neumática y AC6001 compresor de aire (primeras herramientas neumáticas).



1989 Tres herramientas eléctricas (sierra circular, amoladora, taladro) diseñadas por Giorgetto Giugiaro se exhiben en la Exposición Mundial del Diseño en la ciudad de Nagoya.



1989 Se funda Makita España S.A (cambia a Makita, S.A. en 1991)



1991 Se adquiere Sachs Dolmar GmbH, fabricante de motosierras Alemán (cambia el nombre a Dolmar GmbH en 1991)

1991 Llega la segunda marca, MAKTEC.



1997 6213D Taladro atornillador a batería, se exhibe en el salón de ferretería de Chicago (primera herramienta con batería de Ni-MH).

2005 Llegan los modelos BTD130D (primeras herramientas con batería Litio-ion).



2007 Fuji Robin Industries Ltd. se convierte en una subsidiaria consolidada. (cambia su nombre a Makita Numazu Corporation en Agosto de 2007)

2015 Se celebra el 100 aniversario.



2019 30 ANIVERSARIO MAKITA S.A.



2020 Nace XGT, un nuevo sistema con sus propias herramientas, baterías y cargadores. Una combinación de herramientas innovadoras. El diseño y las baterías más potentes proporcionan una solución genuina para usuarios industriales de alta demanda.



2022 Llegamos donde menos te imaginabas. Lanzamos una serie de modelos dedicados al "Outdoor".



Makita - Marca global

Makita ha establecido bases comerciales operadas directamente en aproximadamente 50 países de todo el mundo y ha mejorado

Nuestra red de ventas en más de 160 países y nuestras capacidades de servicio postventa se convierten en una de las compañías líderes en nuestra industria.

Además, Makita está produciendo herramientas eléctricas en plantas en China, EE.UU., Reino Unido, Alemania, Brasil, Rumanía y Tailandia. Actualmente, aproximadamente el 90% del trabajo de fabricación de nuestro grupo en términos de volumen de producción se lleva a cabo en el extranjero.

La red mundial de ventas y servicios de Makita, así como la calidad estable y de alta producción asegurada en sus plantas en todo el mundo, son la encarnación de la marca Makita.



Japón
Makita Corporation



Japón
Planta Okazaki



U.S.A.
Makita Corporation of America



Reino Unido
Makita Manufacturing Europe Ltd.



Rumanía
SC Makita EU SRL



Alemania
Makita Engineering Germany



Brasil
Makita do Brazil Ferramentas Eléctricas Ltda.



China
Makita (China) Co., Ltd.



China
Makita (Kunshan) Co., Ltd.



Tailandia
Makita Manufacturing (Thailand) Co., Ltd.



Por una sociedad descarbonizada.

Makita simboliza el compromiso con el cuidado medioambiental. Trabajamos para crear un modelo de reciclaje eficiente y responsable dirigido a la sociedad, combinando la protección del medioambiente con la revisión de nuestras actividades de negocio y estilos de vida. Esperamos seguir siendo una empresa que cuida encarecidamente del conjunto de la sociedad, desafiándonos a nosotros mismos a orientarnos siempre hacia un reciclaje sostenible.

Modelo :UC012G



 @makita_spain

 Makita España S.A.

 Makita España



1. Baterías y cargadores	33 - 56
2. Perforación y demolición	57 - 88
3. Taladrar	89 - 122
4. Atornillar	123 - 144
5. Limpiar y cepillar	145 - 156
6. Diamante	157 - 170
7. Abrasivo - Amoladoras	171 - 190
8. Abrasivo - Lijas	191 - 208
9. Multiherramienta	209 - 222
10. Sierras circulares, ingletadoras y de incisión	223 - 246
11. Sierras de sable	247 - 260
12. Sierras de calar	261 - 272
13. Fresado	273 - 286
14. Decapar	287 - 288
15. Tornillos y clavos	289 - 294
16. Aspiración	295 - 318
17. Niveles	319 - 322
18. Roedoras, cizallas y punzonadoras	323 - 326
19. Jardín	327 - 354
20. Portaherramientas	355 - 407
21. Baterías NI-Cd / NI-Mh	408
22. Maletines	409 - 417
23. Escobillas	418 - 419
24. Kits de mantenimiento	420
25. Índice por código	421 - 430
Servicios Técnicos Autorizados	434 - 435

Índice

1. Batería y cargadores

- Baterías y cargadores. *págs. 34 - 37*
- Fuentes de alimentación externas. *págs. 38 - 39*
- Kits de fuentes de alimentación *págs. 40 - 41*
- Adaptadores *pág. 42*
- Protectores *pág. 43*
- Varios *págs. 44 - 47*
- Iluminación. *págs. 48 - 56*



2. Perforar y percudir

- Brocas SDS - PLUS. *págs. 58 - 65*



- Brocas SDS - MAX. *págs. 66 - 70*



- Demolición. *págs. 71 - 82*



- Portabrocas y varios. *pág. 83*



- Sistemas de aspiración. *págs. 84 - 87*

- Empuñaduras. *pág. 88*



3. Taladrar

- Brocas:

- Unicut. *pág. 90*
- Ladrillo. *pág. 91*
- Multimaterial. *pág. 92*
- Madera. *págs. 93 - 95*
- Metal. *págs. 96 - 100*



- Brocas para taladro magnético

- HB500 y HB350. *pág. 101*



- Avellanadores. *págs. 102 - 103*



- Estuches y maletines de brocas y accesorios. *págs. 104 - 111*



- Brocas de corona. *págs. 112 - 115*



- Batidores. *pág. 116*



- Soportes para taladros. *págs. 118 - 119*



- Portabrocas. *págs. 120 - 121*



4. Atornillar

- Puntas: *pág. 126 - 127*

Impact

PREMIER

págs. 128 - 131

IMPACT BLACK



- Portapuntas. *pág. 132*



- Llaves de vaso. *págs. 133 - 134*



- Estuches de puntas. *págs. 135 - 136*



- Maletines de herramienta manual. *págs. 137 - 139*



- Boquillas, vasos y acc. para atornilladores. *págs. 140 - 144*



5. Limpiar y cepillar

- Gratas para taladros y amoladoras. *págs. 146 - 151*
- Cepillos de lija para taladros y amoladoras *pág. 152*
- Rodillos para N9741. *págs. 152 - 153*
- Cuchillas para cepillos. *pág. 154*
- Guías. *pág. 155*
- Varios. *págs. 156*



6. Diamante

- Discos de diamante:

quasar *págs. 159*

comet *págs. 160 - 162*

diamant *pág. 163*

Especial herramientas a batería *pág. 164*

X - LOCK *pág. 164*

Especial vidrio y porcelánico *pág. 165*

Especial rescate - Pulir ormigón *pág. 166*



- Brocas de diamante. *págs. 167 - 168*



- Brocas especiales para amoladora. *pág. 169*



- Soportes para DBM131, DBM130 y DBM230. *pág. 170*



- Acc. para PW5005CH. *pág. 170*



7. Abrasivo - Amoladoras

- Discos abrasivos:

Desbarbe y corte. *págs. 172 - 173*

Abrasivo. *págs. 174 - 175*

Láminas. *págs. 176 - 179*



- Muelas. *pág. 180*



- Empuñaduras. *pág. 181*



- Colectores de polvo. *pág. 181*



- Protectores de disco. *pág. 182*



- Varios:

Tuercas. *pág. 183*

Filtros. *pág. 183*

Casquillos para amoladoras rectas. *págs. 184-185*

- Acc. para cortadores. *págs. 186*



- PW5000CH. *pág. 187*

- PC5001C. *págs. 187 - 189*

- DCC501. *pág. 189*

8. Abrasivo - Lijas

- Orbitales. *págs. 192 - 196*

Lijas.

Rollos.

Bases para lijadoras.

- Rotorbitales y de disco. *págs. 197 - 198*

Lijas.

Cajas de lijas.

Platos.

- Lijadoras de banda. *págs. 200 - 201*

Lijas.

Placas.

- Platos, boinas de lana. *págs. 202 - 204*

- Esponjas de velcro. *pág. 205*

- Varios *págs. 206 - 208*

Soportes.

- Bolsas.

- Empuñaduras...



Índice

9. Multiherramienta

- Starlock:
 - Corte y corte de inmersión. *págs. 214 - 216*
 - Rascadores y cuchillas de corte. *pág. 216*
 - Limpieza y corte. *págs. 217 - 218*
 - Set de cuchillas. *pág. 218*
 - Lijas. *pág. 219*
- Starlock Max:
 - Corte y corte de inmersión. *pág. 220*
 - Cuchillas de corte de juntas y de diamante. *págs. 221*
 - Cuchillas de corte para azulejos *pág. 222*
 - Limpieza y corte *pág. 222*



10. Sierras

- Discos para sierras circulares. *págs. 225 - 234*



- Discos para sierras de incisión. *pág. 235*



- Discos para ingletadoras. *págs. 236 - 238*



- Discos para fresado y corte. *pág. 239*
- Discos laminados cortadoras de metal. *págs. 240 - 241*
- Guías. *pág. 242 - 243*
- Mesas. *pág. 244*
- Varios. *págs. 245 - 246*

- Topes
- Soportes
- Mordaza



11. Sierras de sable

- Metal. *págs. 249 - 250*
- Madera. *págs. 251 - 252*
- S-Express. *pág. 252*
- Madera + Metal. *págs. 253 - 254*
- Especiales. *págs. 254 - 255*
- JR100D y DJR183. *pág. 256*
- Hojas para 2107FK / 2107FXK. *pág. 257*
- DPB181 y DSD180. *pág. 258*
- Acc. para LB1200. *pág. 259*
- Acc. para 2107FK. *pág. 260*



12. Sierras de calar

- Super Express. *pág. 264*
 - Madera:
 - Corte básico. *pág. 264*
 - Corte rápido. *pág. 265*
 - Laminadas. *pág. 265*
 - Corte limpio. *pág. 266*
 - Maderas duras. *pág. 266*
 - Con clavo. *pág. 267*
- Metal. *pág. 267*
- Especiales. *pág. 268*
- Conjuntos de hojas a granel. *pág. 269*
- Inserción Makita. *págs. 270 - 271*
- Mordazas, guías y adaptadores. *pág. 272*



13. Fresado

- Madera. *págs. 275 - 278*
- Taladrar aluminio. *pág. 279*
- Para 3706, DCO180 y DCO181. *pág. 279*
- PJ7000 y 3901. *pág. 280*
- 7104L. *pág. 280*
- Varios. *págs. 281 - 282*
- Casquillos.
- Tuercas.
- Llaves.
- Guías. *págs. 283 - 284*
- Plantilla.
- Carril.
- RT0700C. *págs. 285 - 286*



14. Decapar

- Boquillas. *págs. 287 - 288*



15. Tornillos y clavos

- Ristras de tornillos para autoalimentados. *pág. 291*
- Clavos. *págs. 292 - 293*
 - DPT351 y DPT353 - 0,6mm.
 - AF506 y DBN500 - 1,2mm.
 - AN250HC - Multimaterial.
 - GN420C - Multimaterial.
 - Cargador de clavos - GN420C.
- Grapas. *pág. 293*
- Varios. *pág. 294*



16. Aspiración

- Accesorios para aspiradores. *págs. 298 - 306*
 - Tubos:
 - Flexibles.
 - Curvos.
 - Rectos.
 - Pies.
 - Boquillas.
- Filtros. *pág. 307*
- Bolsas. *pág. 307*
- Accesorios para aspiradores de mano. *págs. 308 - 309*
- Accesorios para aspirador de pie y portátil. *págs. 310*
- Accesorios para aspiradores de mochila y robots aspiradores. *pág. 311*
- Varios. *pág. 314 - 318*



17. Láser

- Varios. *págs. 319 - 322*



18. Roedoras, cizallas y punzonadoras

- JN1601, JN3201, JS8000 Varios. *pág. 324*
- Cuchillas para DJS200 *pág. 325*
- Accesorios para DPP200 *pág. 325*
- Accesorios para punzonadora DPP200. *págs. 326*



19. Jardín

- Barras, cadenas, fundas y acc. para sierras de cadena y cortasetos *págs. 330 - 332*
- Accesorios pistola de soplado AS001G *pág. 333*
- Acc. para sopladores. *págs. 334 - 335*
- Acc. para cortasetos y cortahierbas. *pág. 336 - 337*
- Acc. para UX001G / DUX60 / DUX18. *pág. 338 - 339*
- Discos y cabezales para desbrozadores. *pág. 341*
- Cabezales e hilos de nylon. *págs. 342 - 344*
- Aceites. *pág. 345*
- Corraje y protección para desbrozadores. *pág. 346*
- Acc. para ahoyadora DDG460. *pág. 347*
- Brocas para suelo 3/4". *pág. 348*
- Acc. para DUC122 y UC120D. *pág. 348*
- Acc. para tijeras de poda. *pág. 349*
- Accesorios para carretillas DCU603, DCU604, DCU605 y DCU180 *pág. 350 - 351*
- Hidrolimpiadoras. *págs. 352 - 354*



Makita. Recomendaciones de seguridad.

Importante



- Cuando utilice herramientas eléctricas, siempre deben seguirse unas recomendaciones de seguridad básicas para reducir el riesgo de incendio, electroshock y daños personales, como las que se indican a continuación.

Mantenga la zona de trabajo limpia

Las zonas y mesas de trabajo desordenadas pueden provocar lesiones.

Tenga en cuenta el ambiente de trabajo

No utilice herramientas eléctricas en ambientes húmedos o mojados. Mantenga el Área de trabajo iluminada. No esponga herramientas eléctricas a la lluvia. No utilice herramientas eléctricas en presencia de líquidos o gases inflamables.

Mantenga a los niños alejados

Todos los visitantes deben mantenerse alejados de la zona de trabajo. No permita que los visitantes toquen la herramienta o los cables de extensión.

Guarde las herramientas en un lugar apropiado

Cuando no se encuentren en uso, las herramientas deben ser guardadas en un lugar seco y a una altura que las mantenga fuera del alcance de los niños.

No fuerce la herramienta

Realizará mejor su trabajo y de una manera más segura al paso para el que ha sido destinado.

Use la herramienta apropiada

No fuerce pequeñas herramientas o accesorios para hacer el trabajo de una herramienta mayor. No utilice herramientas para propósitos para los que no han sido diseñadas.

Vista de forma adecuada

No lleve ropa holgada o joyas. Pueden quedarse atrapadas entre partes móviles. Se recomienda el uso de guantes de goma y calzado antideslizante para trabajos en el exterior.

Haga un uso adecuado del cable

Nunca mueva la herramienta por su cable ni tire de él para desconectarlo del enchufe. Mantenga el cable lejos del calor, aceite y ángulos afilados.

Trabaje de manera segura

Utilice abrazaderas para sostener el trabajo. Es más seguro que usar su mano para sostenerlo y le permite utilizar la herramienta con ambas manos.

No se extralimite

Manténgase en todo momento seguro y en equilibrio.

Mantenga las herramientas con cuidado

Mantenga las herramientas de corte afiladas y limpias para un uso más seguro y eficaz. Siga las instrucciones sobre lubricación y cambio de accesorios. Inspeccione el cable de la herramienta periódicamente y si está dañado, repárelo en un servicio autorizado. Inspeccione los cables de extensión periódicamente y cámbielos si están dañados. Mantenga los mangos secos, limpios y libres de grasa y aceite.

Desconecte las herramientas

Cuando no se encuentren en uso, antes de utilizarlas y cuando cambie accesorios como cuchillas.

Retire las llaves de ajuste e inglesas

Acostúmbrese a comprobar que ha retirado las llaves de ajuste o inglesas que haya utilizado para ajustar la máquina antes de su encendido.

Evite el encendido accidental

No lleve una herramienta conectada con un dedo en el interruptor. Asegúrese de que el interruptor está en la posición OFF cuando vaya a conectarlo.

Utilice extensores para exterior

Cuando utilice la herramienta en ambientes externos utilice solo cables de extensión destinados a este uso.

Manténgase a alerta

Observe lo que está haciendo. Utilice el sentido común. No utilice la herramienta cuando esté cansado.

Compruebe las partes dañadas

Antes de seguir utilizando la herramienta, las protecciones o cualquier parte que se encuentra dañada, deben ser comprobadas para determinar si funcionarán correctamente y ejecutarán su propósito. Compruebe la alineación y el desplazamiento de los elementos móviles, roturas, montaje y cualquier otra condición que pueda dañar su funcionamiento. Los protectores o cualquier otra parte dañada deben ser reemplazados o reparados por un servicio autorizado a menos que se indique de otra manera en su manual de instrucciones. Reemplace sus interruptores en un servicio autorizado. No utilice la herramienta si el interruptor no la enciende ni apaga.

Protéjase contra electroshocks

Evite el contacto directo del cuerpo con superficies con toma de tierra (por ejemplo, tuberías, radiadores, refrigeraciones, etc...)

Repuestos

Utilice solamente recambios idénticos a la pieza original.

Advertencia de voltaje

Antes de conectar la herramienta a una fuente de alimentación. Asegúrese de que el voltaje suministrado es idéntico al que figura en la placa nominativa de la herramienta. Un voltaje mayor al especificado en la herramienta podría causar SERIOS DAÑOS al operario así como a la propia herramienta. En caso de duda, NO CONECTE LA HERRAMIENTA. Usar una fuente de alimentación con voltaje menor al indicado es perjudicial para el motor.

NOTA

Makita se reserva el derecho a cambiar especificaciones de las herramientas, equipos básicos y accesorios sin previo aviso. El equipamiento básico y especificaciones de piezas puede variar según el país. El color estándar de fábrica es el Verde Industrial Makita (azul). Por favor indique el voltaje necesario en cada pedido. Estas ofertas están sujetas a disponibilidad en cada país.

El color de los productos puede variar ligeramente con respecto al color reproducido en el presente catálogo.

Se recomienda siempre completar la información contenida en este catálogo mediante consulta telefónica o correo electrónico.

Makita Limited

Garantía

Todas las herramientas Makita sufren un duro proceso de inspección y testeo antes de abandonar la fábrica. Están garantizadas contra defectos de fabricación y/o materiales. Si algún problema hace aparición, por favor envíe la herramienta COMPLETA a Makita o entréguela en su punto de venta habitual. Si tras la inspección se demuestra que el problema es debido a un fallo de fabricación/material, todas las reparaciones necesarias será efectuadas sin coste alguno. La garantía no cubre reparaciones llevadas a cabo por terceros; reparaciones debidas a un desgaste normal; uso inapropiado de la herramienta o caída accidental; mal uso evidente – causado por sobrecargar la herramienta por encima de su capacidad, usar la herramienta después de una avería parcial o usarla con accesorios inadecuados.

Riesgos y desventajas del uso de falsificaciones

ATENCIÓN: Makita informa

- Lamentablemente, la tendencia de comprar online ha creado espacios para los oportunistas y estafadores que buscan aprovecharse del consumidor a toda costa. Los productos de imitación relacionados con la construcción se están volviendo cada vez más comunes en internet, particularmente a través de subastas donde el vendedor es anónimo, y su uso puede generar graves problemas. A continuación explicamos las claves para diferenciar nuestras herramientas y accesorios originales:



Logotipo de Makita

El logotipo de Makita tiene que estar moldeado directamente en la carcasa de la herramienta y con el símbolo de marca registrada ®.



Etiqueta

Las etiquetas de Makita tienen que coincidir en modelo y especificaciones con la herramienta que las lleva. Las etiquetas falsas suelen tener el nombre del modelo en minúscula.



Acabado

El acabado de las herramientas Makita es metálico pulido. Las falsificaciones suelen llevar un baño de laca para aparentar este brillo.



Componentes

Los componentes de las herramientas Makita son siempre de calidad superior, más duraderos y de mejor material.



Componentes

Registrando la herramienta en www.makita.es, Makita otorga hasta tres años de garantía a todos sus modelos. Dentro de la caja se encuentran los comprobantes de dicha garantía, que las falsificaciones no tendrán.

Packaging

Los maletines o cajas de cartón donde vienen las herramientas de Makita tienen mayor calidad y protegen mejor el producto ya que se adaptan mejor al modelo que contienen.



ATENCIÓN: UTILICE BATERÍAS ORIGINALES

Seguridad

En muchos casos, los productos falsificados no han sido fabricados ni testeados de acuerdo con los estándares de calidad y seguridad requeridos por la ley. Entre estos riesgos se encuentra el peligro de que el producto quede dañado como resultado de una fuga o sobrecalentamiento de la batería hasta tal punto que pueda incendiarse.

Calidad

No es posible garantizar el rendimiento correcto de una batería falsificada. Hay baterías no originales en el mercado que afirman tener los mismos Ah que las baterías de Makita, pero son significativamente menos potentes. Una batería original de Makita también incluirá un chip incorporado que optimiza la vida útil de la batería.

Cómo identificar baterías falsificadas

Al comprar productos es importante reconocer aquellas señales de advertencia que indiquen que el producto es original. Recomendamos comprar a distribuidores autorizados de Makita España y ser cauteloso con los vendedores con precios inusualmente bajos.



Gracias a los aspiradores Makita, conseguirás un espacio limpio y seguro.

El filtro HEPA elimina más del 99,75% de las partículas que hay en el aire.

HEPA
filter



Baterías de mochila

18Vx2 LXT / 36V / 40Vmax 33,5Ah

Hasta 6 veces más de tiempo de trabajo con herramientas de 18Vx2 LXT y 6,0Ah.



PDC1200A01*
PDC1200A02



* Incluye adaptador 18Vx2 LXT



- El arnés de extracción rápida permite el uso de esta batería como fuente de alimentación fija.
- Interruptor de alimentación principal con función de apagado automático.



Ajuste de altura de la batería para comodidad del usuario.



Indicador de carga de batería de 4 LED.

PDC1200A01* **PDC1200A02**
1.854,00 € **1.741,00 €**

- El modelo PDC1200 es una batería con una capacidad de 1200 Wh, 33,5Ah y un voltaje 36V - 40Vmax (aproximadamente).
- Hasta 2,8 veces más de tiempo de duración que nuestra mochila portabaterías PDC01 cargada con 4 baterías 18V LXT 6,0Ah (BL1860B).
- Compatible con tres plataformas: 18Vx2 LXT (con adaptador opcional), conexión de alimentación directa de 36V y próximamente con 40Vmax XGT (adaptador en desarrollo).
- Batería no compatible con aspiradores, tijeras de poda, sierras de cadena a excepción del modelo DUC355, sierra circular DHS710 y la serie de martillos ligeros DHR280.
- Gracias a la estructura del arnés, la batería puede mantenerse en el suelo de forma vertical.

CONSTRUCCIÓN DE LA BATERÍA

Muy duradera y resistente. Especialmente diseñada para la nueva gama 40V máx.



Paredes de protección. Protegen los terminales de agua y polvo.

4 Led.

Indicador de carga.

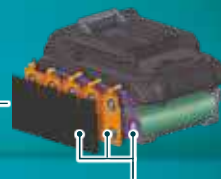

Triple capa impermeable.



Railes rígidos de gran durabilidad.



Espacio entre las celdas y la carcasa para proteger la batería frente a impactos.

Gama 40V máx



Litio - Ion



Registrando su herramienta en la web, extenderá la garantía hasta un máximo de tres años desde la fecha de compra.

www.makita.es





XGT es un sistema desarrollado por Makita con sus propias herramientas, baterías y cargadores.

Una combinación de herramientas innovadoras. El diseño y las baterías **MÁS POTENTES** proporcionan una solución genuina para usuarios industriales de alta demanda.



BATERÍA DE ALTA POTENCIA

XGT es una solución genuina para las aplicaciones industriales de alta demanda, siendo una combinación del diseño innovador de la herramienta y la alta potencia de las baterías.



TECNOLOGÍA INTELIGENTE

La gama de herramientas y baterías XGT lleva un programa incorporado, que proporciona una comunicación digital entre la batería y la herramienta en ambos sentidos.



DURABILIDAD

¡XGT es duradero y está diseñado para trabajar! Las baterías y herramientas XGT también han sido construidas para soportar las condiciones ambientales y meteorológicas difíciles.



LISTO PARA EL FUTURO

XGT y LXT convivirán para proporcionar a los usuarios una gama inigualable de herramientas a batería en las aplicaciones comerciales profesionales.



Características

La gama de herramientas y baterías XGT vienen con un chip incorporado, que proporciona comunicación digital entre la batería y la herramienta y el cargador. Tecnología de la batería e ingeniería del motor para que trabajen juntos de una manera óptima.

Las baterías tienen ralles rígidos que las mantienen firmemente en su lugar cuando se utilizan los nuevos productos de alta potencia.

Paredes de protección. Protegen los terminales de agua y polvo.

Indicador de carga de 4 LED que se encuentra en la parte delantera de la batería para que sea fácil saber cuándo debe recargarse.

El resistente diseño de 40Vmax carga las baterías en tan solo 28 minutos (BL4025).

Un accesorio adaptador de carga permite la carga de productos LXT y XGT (más de 320 en total).

Sistema óptimo de carga

Cargador rápido

Si la temperatura de la batería es alta, es necesario que esta se enfríe antes de comenzar la carga. El ventilador incorporado hace circular el aire a través de la batería antes de comenzar a cargar y durante el proceso de carga para enfriarla. De esta forma, el tiempo de carga es menor.

Sistema óptimo de carga.

Enfriamiento por aire forzado.



Carga rápida.



Sistema de carga general.

Enfriamiento natural.



Mayor tiempo de espera para cargar.



El cargador rápido de Makita se comunica con el chip incorporado de la batería durante todo el proceso de carga para optimizar la vida útil de la batería. Controlando la corriente, el voltaje y la temperatura.



Sistema óptimo de carga.

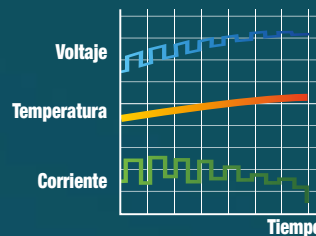

Sistema de carga general.

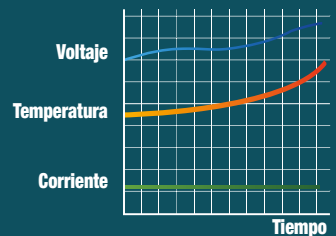

Protección de la batería



Sobredescarga

Sobrecarga

Estado de alta temperatura

Sobrecarga

Esta función es la tecnología de comunicación que permite la herramienta y la batería para monitorizar las condiciones e intercambiar datos en tiempo real. De esta forma se protege contra sobrecarga y sobrecalentamiento.

Carga en cualquier momento

Sin efecto memoria.
No se requiere descarga.

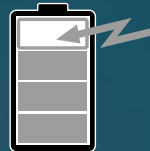

Muy resistente.

Carcasa dura.

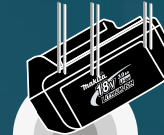

Larga duración.

Baja auto descarga.



Comunicación constante entre herramienta y batería

40% más ligera



Makita
18V Litio-Ion 5,0Ah
14,4V Litio-Ion 5,0Ah

Makita
18V / 14,4V
Ni-Mh 2,8Ah



Terminales multicontacto

Reducen la resistencia eléctrica y aumentan la estabilidad de la conexión. Resistentes contra las vibraciones, y en última instancia asegura suministro de corriente estable a la herramienta.



18V
LITIO-ION

LXT
Litio-ion EXTREMA TECNOLOGIA

Más de
360 modelos
con la misma
batería



Fácil de usar



Puesta en marcha.



Necesitan más tiempo para arrancar.

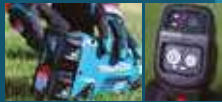

Funcionan nada más insertar la batería y encender la máquina.

Control de velocidad constante.

Herramientas a gasolina

Herramientas a batería



Más difícil de mantener una velocidad de rotación constante.



Se mantiene una velocidad de rotación constante.

Ruido bajo Comparación de nivel de ruido.

Herramientas a gasolina

Herramientas a batería



=



Ventajas de la batería

Fácil limpieza y mantenimiento



Sin emisión.

Herramientas a gasolina

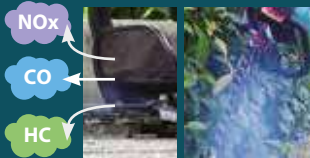

Generan gases de escape.

Herramientas a batería



No generan ningún tipo de gas de escape

Reduce coste y tiempo.

Herramientas a gasolina



Lleva tiempo preparar la mezcla de combustible para el motor.

Herramientas a batería



Inserta la batería en la máquina y estará lista para usar.

Fácil mantenimiento.

Herramientas a gasolina

Requiere mantenimiento.



Aceite. Filtro de aire. Bujía. Tapón de combustible. Engrase.

Herramientas a batería

No requiere mantenimiento.



Almacenarla por mucho tiempo.

Herramientas a gasolina

Si guardas la máquina con el combustible dentro durante mucho tiempo, puede ocasionar problemas en el motor. Antes de guardar la máquina, extraer el combustible.



Herramientas a batería

Si guardas la máquina por mucho tiempo, podrás usarla al momento nada más insertar la batería.



Accesorios ideales para herramientas a batería



¡Proporcionan el mejor rendimiento en las herramientas a batería!

Mayor velocidad, más cantidad de trabajo con una sola carga de batería completa y una buena sensación de uso.

Puede encontrar accesorios recomendados para herramientas a batería con los símbolos arriba indicados.

¡Pruebe y vea nuestra amplia gama de accesorios Makita!



Impact
PREMIER



Mayor precisión de encaje.

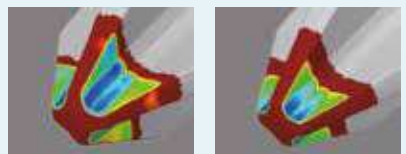

Con un tornillo cerca

Con un tornillo a distancia



Estándar

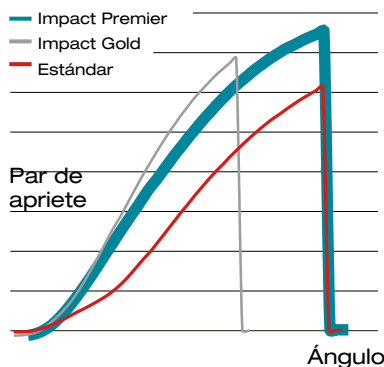

Doble torsión que consigue mayor durabilidad.



Sierra de sable de diente japonés



Dientes japoneses de 0,6mm de grosor para un corte más limpio del material.

Sierra de diente japonés:

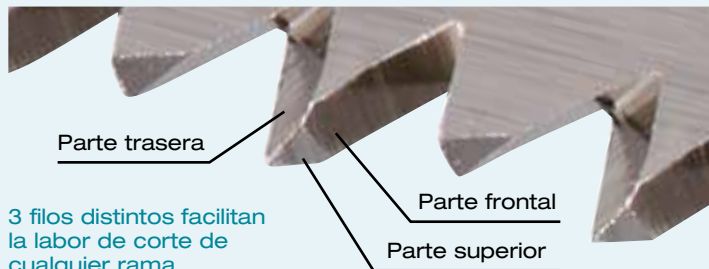

Calidad superior



Acabado con diente japonés



Acabado con diente normal



Hilo de nylon de cuatro hojas

Cuatro hojas

Forma de cuatro hojas que reduce el ruido y aumenta el tiempo de trabajo.



Características

La forma del hilo de cuatro hojas crea un pequeño vértice que reduce el ruido del corte y alarga el tiempo de trabajo debido a que ejerce menos resistencia.

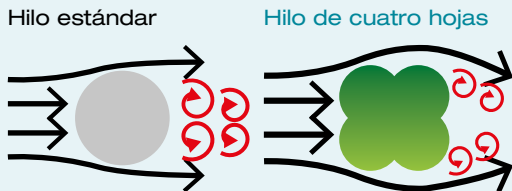

Cantidad de cortes por una carga

Ruido

120
100

20% más

90,5dB
97dB

6,5dB menos



Redondo



Cuatro hojas



Redondo



Cuatro hojas

Cadena para sierras serie 80



Características

Forma de corte óptima para corte suave

Paso de cadena corto para reducir la vibración

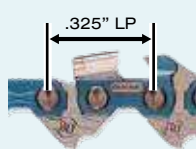
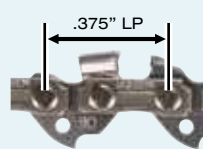
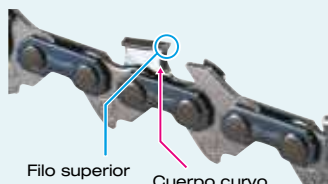

Vibración



Serie 80



90PX



Serie 80



90PX

85
100

15% menos

Cantidad de cortes por una carga

125
100

20% más

Brocas de corona

Ezychange

- BI-Metal HSS 8%Co
- TCT



Cambio de un sólo click

Brocas de corona fácilmente intercambiables

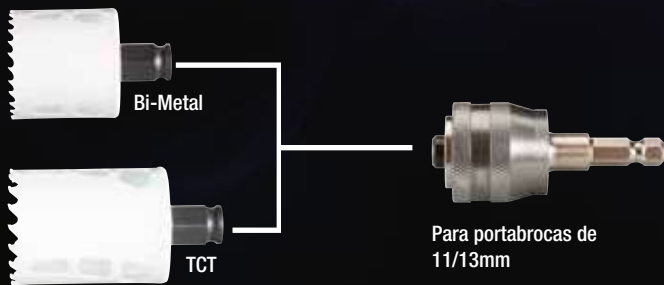

De fácil limpieza y extracción de trozos de madera

Simplemente insertando una broca recta por dentro.



Con barra de extensión (150/300mm)

Para portabrocas de 13mm

Ezychange

BI-Metal HSS 8%Co

Tamaño variable para un corte más rápido



Gracias a la capacidad de 44mm, los usuarios podrán perforar material de 38mm 2x4 con facilidad

Puede hacer perforaciones en acero de 3mm de grosor con HSS BiM de 8%Co

Ezychange

TCT

TCT de alta durabilidad



Diseñadas con un largo de 60mm para poder hacer perforaciones en composite y contrachapado de 2x4 o 2x6

Puede hacer perforaciones en acero de 3mm de grosor y otros materiales más que BiM de TCT

Broca de corona BiM



Broca de corona TCT

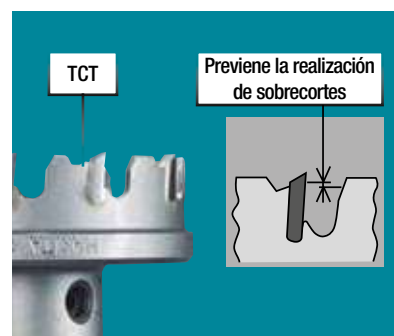



Brocas T.C.T para martillos SDS-Plus

Producto	Standmak	V-Plus	SDS-V-Plus Mak 4	NEMESIS
Rango	★★	★★★★	★★★	★★★★★
Punta				
Tipo	Pastilla de 2 cortes	Pastilla de 2 cortes	Pastilla de 4 cortes	Pastilla sólida de 4 cortes
Espiral	Espiral doble estándar	Espiral doble de alta durabilidad	Espiral doble estándar	Espiral cuádruple de alta durabilidad
Tamaño	3,5 - 30mm	3,5 - 26mm	5 - 25mm	5 - 32mm
Equilibrio de propiedades				
Material de trabajo				

La pastilla sólida de 4 cortes sólo está disponible hasta brocas de 16mm Ø

Brocas T.C.T para martillos SDS-Max



Producto	Standard	Mak 4
Rango	★★	★★★
Punta		
Tipo	Pastilla de 2 cortes	Pastilla de 4 cortes
Espiral	Espiral doble estándar	Espiral doble estándar
Tamaño	12 - 40mm	12-30mm
Equilibrio de propiedades		
Material de trabajo		





Sierras circulares TCT EFFICUT

EFFICUT



Características

Eficiente
Ángulo superior agudo



Eficiente
Cuerpo curvo

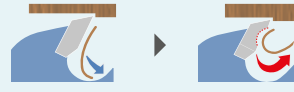

Eficiente
Base rectificada



Cantidad de cortes por una carga

100

140% más

240

Estándar
165mm x 48T

EFFICUT
165mm x 56T

EFFICUT Composite



Características

Eficiente
Base rectificada



Eficiente
Cuerpo curvo

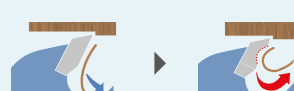

Cantidad de cortes por una carga

100

30% más

130

Estándar
180mm x 40T

EFFICUT
185mm x 40T

EFFICUT Metal



Características

Reduce la rebaba
Mayor robustez



Corte más suave
Reduce ruido y vibración



Mayor productividad
Superior en corte recto

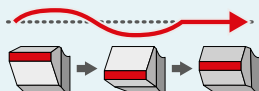

Cantidad de cortes por una carga

100

60% más

160

Estándar
150mm x 32T

EFFICUT
150mm x 33T

EFFICUT Aluminio



Características

Reduce la rebaba
Mayor robustez



Corte más suave
Reduce ruido y vibración



Mayor productividad
Superior en corte recto

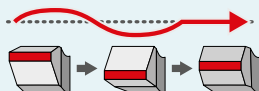

Optimización del trabajo
Menor resistencia de corte



Cantidad de cortes por una carga

100

40% más

140

Estándar
260mm x 80T

EFFICUT
260mm x 81T



Disco de diamante segmentado
Ideal para cortadores a batería

Los diamantes se distribuyen en la estructura del segmento, así se logra un mayor rendimiento de trabajo.
Ranuras más estrechas, mayor capacidad de corte.



Estándar

Para batería

Cantidad de cortes por una carga

100

65% más

165

Disco abrasivo para metal
Ideal para cortadores a batería

Mezcla ideal de grano abrasivo y aglomerante para cortadores a batería.

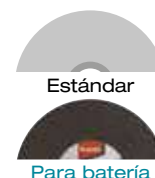

Estándar

Para batería

Cantidad de cortes por una carga

100

10% más

110



0,8mm



Disco de corte fino

0,8mm de grosor para un corte más rápido

Grosor reducido

Corte rápido / menor resistencia de corte / mejores acabados / menor producción de polvo



Estándar
1mm de grosor



Para batería
0,8mm de grosor

Cantidad de cortes
por una carga

100

120

20%
más

1,4mm

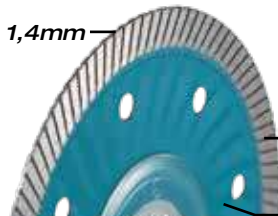

Disco de diamante seg.

Corte suave y preciso

Grosor reducido sin perder fuerza

Con 1,4mm consigue un cortes suaves y precisos.

Con un interior corrugado que aumenta la tensión y reduce las vibraciones durante el corte.

Para azulejos



Estándar
2,3mm de grosor



Para batería
1,4mm de grosor

Cantidad de cortes
por una carga

100

160

60%
más

1,6mm

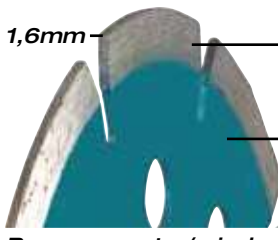

Especial para trabajos de corte

Con 1,6mm consigue cortes suaves y precisos en cemento o piedra.

El cuerpo del disco es más ligero que en los modelos anteriores, haciendo más fácil el corte y aumentando el tiempo de uso con una batería totalmente cargada.

Para cemento / piedra



Estándar
2,2mm de grosor



Para batería
1,6mm de grosor

Cantidad de cortes
por una carga

100

150

50%
más

XLOCK



Disco de corte fino

Disco de diamante

Disco de desbarbe



Cambio rápido

Aumenta la rapidez en el cambio de accesorios sin piezas de intercambio.



Sin herramientas

El cambio de disco se puede realizar sin necesidad de herramientas externas.



2,5mm



Disco abrasivo para metal

Especial para trozadoras

Grosor reducido y aglomerante óptimo

2,5mm de grosor de disco para un corte suave y más rápido. Con un aglomerado óptimo que aumenta la vida útil del disco.



Estándar
3mm de grosor

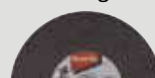

Para batería
2,5mm de grosor

Cantidad de cortes
por una carga

100

130

30%
más



Discos abrasivos de amoladora

Nuevo diseño

Pictogramas para uso seguro



País de origen

Made in China

Código

D-74491

Tamaño

125x6x22.23mm
5"x1/4"x7/8"

Instrucciones de uso
(véase punto 1)



Aplicación
(véase punto 4)

Especificaciones
(véase punto 3)

Estándar

Máxima velocidad
de trabajo

Metal



T27 A24P-BF

EN12413

max.80m/s
(4800 m/min)
max.12250min⁻¹
(12250rpm)

Marca de rango
(véase punto 2)

Punto 1 El icono muestra el uso correcto

	Para metal	Para INOX	Para ladrillo / mampostería	Para aluminio
Desbarbar				
Para corte en amoladoras				
Para corte en tronadoras			-	
Para corte en cortadores		-		-

Discos abrasivos de amoladora

Punto 2 Las marcas hacen referencia al rango y a la calidad

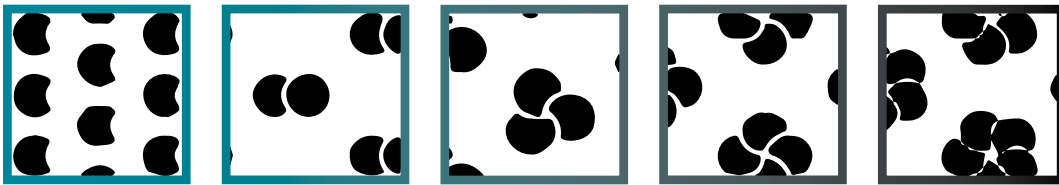

Rendimiento Calidad

Punto 3 Especificaciones



Óxido de aluminio (principalmente para metal y INOX)

Aluminio fundido marrón: A

El material más común en abrasivos para metal.



Óxido de aluminio simple: SA

Abrasivo de cristal simple con alta durabilidad. Mayor rendimiento para cortar/desbarbar que el A.



Óxido de aluminio blanco: WA

Material abrasivo de alta pureza. Mayor rendimiento para cortar/desbarbar que el A.



Zirconio: Z

Material abrasivo muy afilado y duro. Mayor rendimiento para cortar/desbarbar que el SA.



Cerámico:

Material abrasivo muy afilado, de alta durabilidad y resistente a golpes/calor. Abrasivo de alta calidad para cortar/desbarbar con rendimiento aumentado.



Óxido de silicio (principalmente para materiales no metálicos)

Carburo de silicio negro: C

El material más común en abrasivos para materiales no metálicos.



Carburo de silicio verde: GC

De mayor pureza que el C, consiguiendo un rendimiento aumentado respecto a este, pero a su vez una menor durabilidad.



Tamaño del grano

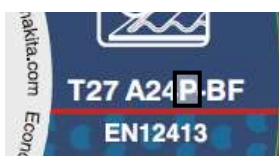
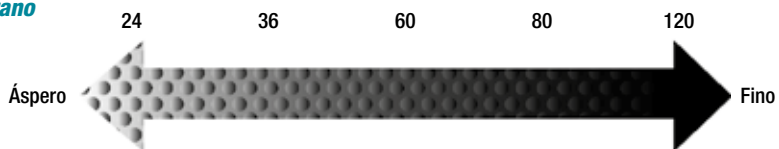

Dureza del abrasivo

Cuanto más cerca de A, más suave será el abrasivo. Cuanto más cerca de Z, más duro.

Abrasivo blando ▶ Material duro
Abrasivo duro ▶ Material blando

Muy blando	Blando	Medio	Duro	Muy duro
A - G	H - K	L - O	P - S	T - Z



Tipo de resina

BF: Resina reforzada
V: Resina vitrificada



Punto 4 El color indica el tipo de aplicación

	Para metal	Para INOX	Para ladrillo / mampostería	Para aluminio
Color				
	Azul	Naranja	Verde	Gris

Discos de láminas de amoladora

Nuevo diseño



Punto 1 El icono muestra el uso correcto

	Para metal	Para INOX	Para ladrillo / mampostería
Desbarbar			



Punto 2 Las marcas hacen referencia al rango y a la calidad

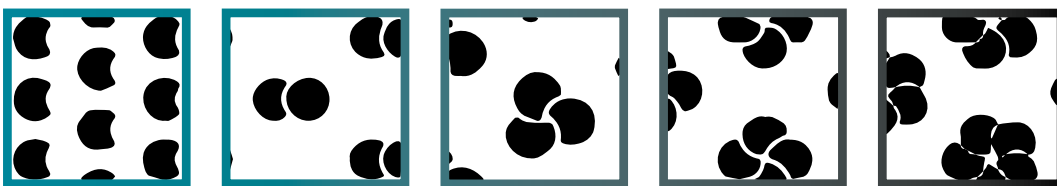

Rendimiento Calidad

Punto 3 Las marcas hacen referencia al rango y a la calidad

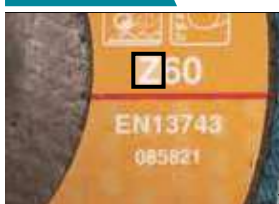

Óxido de aluminio (principalmente para metal y INOX)

Aluminio fundido marrón: A

El material más común en abrasivos para metal.

Zirconio: Z

Material abrasivo muy afilado y duro. Mayor rendimiento para cortar/desbarbar que el SA.



Óxido de silicio (para materiales no metálicos)

Carburo de silicio negro: C

El material más común en abrasivos para materiales no metálicos.



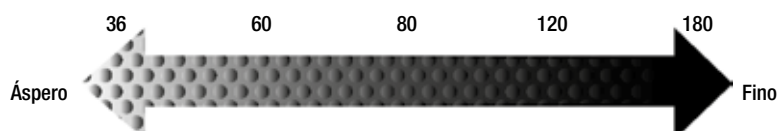

Tamaño del grano



Discos de láminas de amoladora

Punto 4 *El color indica el tipo de aplicación*

	Para metal	Para INOX	Para ladrillo / mampostería
Color	 Azul	 Naranja	 Verde

Tipo de soporte



Soporte de fibra de vidrio
Soporte estándar.



Soporte de nylon
Para trabajos pesados.

inclinación de las láminas



Plano
Para superficies rectas.



Curvo
Para esquinas o ángulos.

Tabla de materiales

*Tras leer el manual de instrucciones de la amoladora, escoja material de trabajo.

☆☆ Recomendado ☆ Posible

Descripción del material	Óxido de aluminio 	Zirconio 	Carburo de silicio 
Guía de color y aplicación	 Trabajo óptimo en metal	 Trabajo óptimo en metal e INOX	 Trabajo en ladrillo / mampostería
Plástico 	☆		
Metal 	☆☆	☆☆	
No metales 	☆	☆	
INOX 		☆	
Ladrillo / mampostería 			☆☆



Sierras de sable

Tipos de dientes

Diente triscado fresado

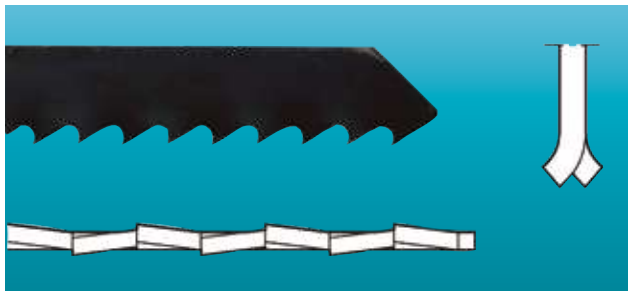

Diente triscado prensado

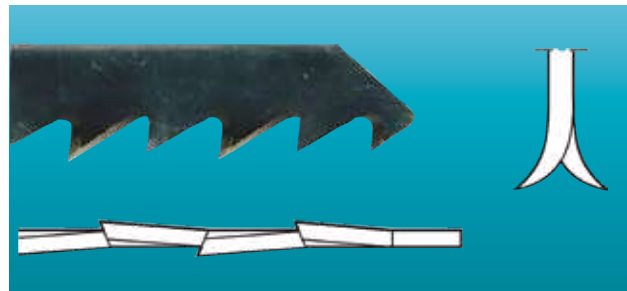

Diente ondulado fresado

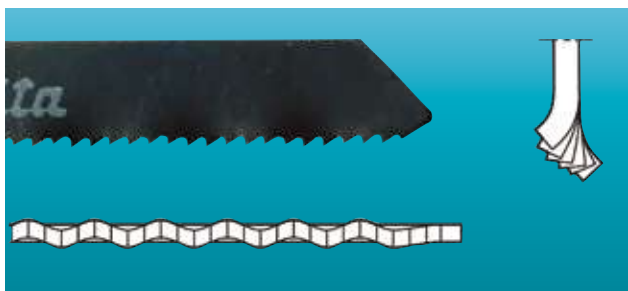

Diente recto prensado

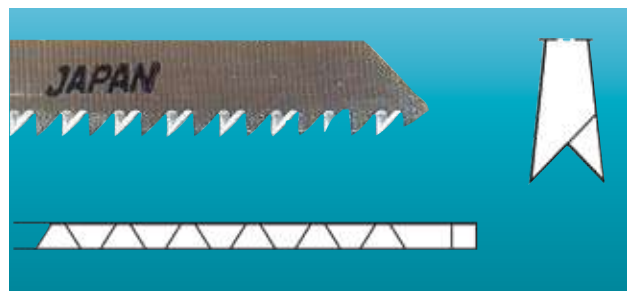

Fabricación de los dientes

Dientes fresados

- Coste reducido de fabricación
- Para realizar cortes generales menos precisos
- Para cortar materiales blandos y duros
- Uso útil de la hoja prolongado



Dientes prensados

- Coste de fabricación mayor
- Mayor afilado
- Para cortes más precisos
- Para cortar materiales blandos y medios



Método de fabricación

Triscado: Cada diente se dobla hacia la derecha o hacia la izquierda manualmente, dejando uno centrado después. Ej: Izquierda, derecha, centrado, etc.

Ondulado: La hilera entera de dientes se moldea para tener una forma curva y ondulada.

Recto: La hilera de dientes se hace más estrecha obteniendo una forma cónica.

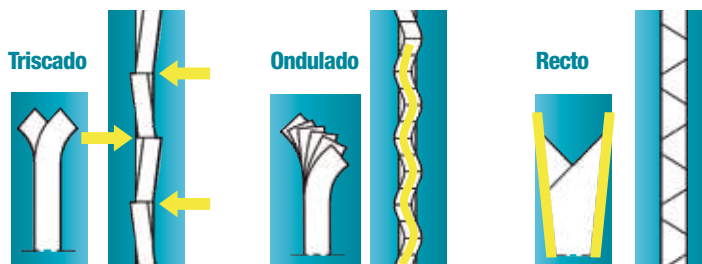

Material de las sierras

HCS (Acero de alto carbono): Para cortar materiales más blandos como maderas o plásticos.

HSS (Acero de alta velocidad): Para cortar materiales más duros como metales.

BiM (Bi-Metal, Base HCS y dientes HSS): Al combinar ambos tipos de aceros, podemos cortar materiales blandos y duros.

TC (Carburo de tungsteno): Para cortar plásticos reforzados con fibra de vidrio, tableros de fibra aglomerada con cemento o cartón-yeso.



Makita®

40V max
LITH-ION

XGT

18V
LITH-ION

14.4V
LITH-ION

LXT
LITH-ION TECHNOLOGY

12V max
LITH-ION

CXT



FOLLETO DE ILUMINACIÓN 2023

Cadena y guía de cadena para sierras

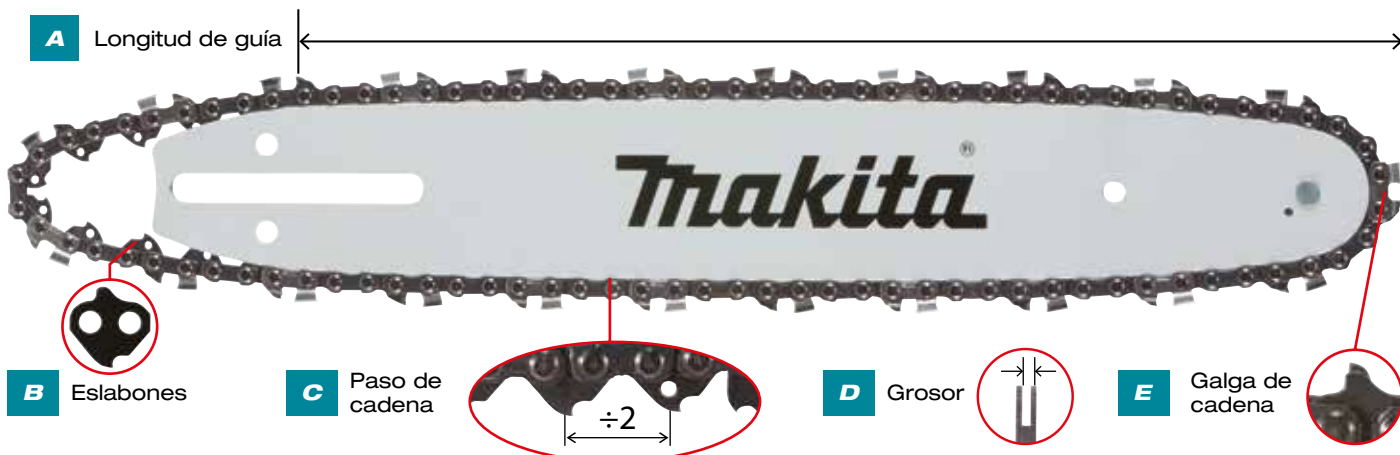

A Longitud de guía

La longitud de la guía de cadena se refiere a su longitud de corte, que es diferente al largo total de la espada.

B Eslabones

La longitud de la cadena viene determinada por el número de eslabones que tiene.

C Paso de cadena

El paso de cadena se determina por la distancia entre tres remaches consecutivos dividida entre dos. El piñón de embrague y el delantero deben tener el mismo paso.

D Grosor

El grosor de la cadena debe de encajar dentro de la guía de cadena y por lo tanto debe de coincidir con esta en anchura.

E Galga de cadena

La galga de la cadena determina la profundidad a la que cortan los dientes de la cadena. La profundidad de corte se puede comprobar por la distancia entre el filo del piñón y el siguiente eslabón.

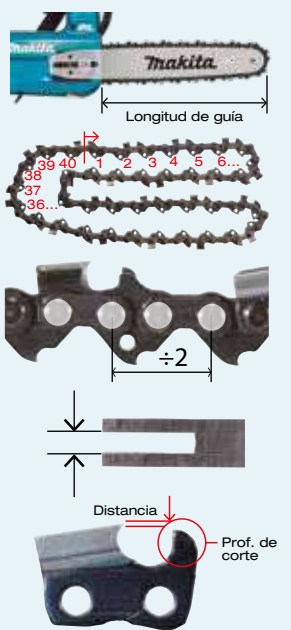

Tipos de cadenas

D Grosor	Velocidad de corte			
	Rápido		Lento	
C Paso de cadena	0.043" (1.1mm)	0.050" (1.3mm)	0.058" (1.5mm)	
Superficie	1/4"		25AP 25F	
	Liso	.325" LP	80	
	↑	3/8" LP	90PX	91PX 91F 91VXL
		.325"		20BPX 95VPX
	↓	3/8"		73DPX 73LGX 73LPX

Tipo de guía de cadena

Guías de estrella

Estas guías tienen un piñón rotatorio en la parte delantera que hace que la cadena se mueva con menos fricción a lo largo de la guía.



Guías blindadas

La punta de esta guía tiene un refuerzo de estelite que la hace más resistente, no tiene piñones. Para aplicaciones especiales de alta resistencia.



Guías de carving

Estas guías llevan refuerzo de estelite y son de un acero de alta calidad. La parte delante es más fina para un corte de mayor precisión.



Mantenimiento de la guía y la cadena

Tensión de la cadena

La cadena puede destensarse tras periodos de trabajo largos y continuados.



Filo de los piñones

Lime los bordes de los piñones una vez a la semana para mantenerlos en un ángulo de 90°.



Limpieza de guía

Retire astillas y polvo de madera de la guía de la cadena cada cierto tiempo.



Nivel de grasa

Compruebe el nivel de grasa de los piñones regularmente para un funcionamiento más óptimo.



Afilado de dientes de la cadena

Lima redonda y sujeción

La lima puede ser usada con mayor precisión con una guía. La guía tiene marcas para determinar el ángulo óptimo de limado a 30° y limita la profundidad de limado.

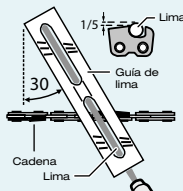

Calibrador de profundidad

Tras afilar los piñones de la cadena, podremos medir la profundidad de corte de esta usando el calibre de profundidad.











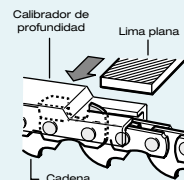



Tabla de tipos de cabezal y sus usos

Tipo de cabezal / Uso				
		Hierba corta y fina	Hierba larga y gruesa	Arbustos y árboles finos
Cabezal de nylon		←→		
Cabezal de polycut		←→		
Discos de metal			←→	
			←→	
			←→	
Disco cortasetos			←→	
Triturador			←→	
Disco de sierra				←→
Disco de cincel				←→









Sets de maletines de accesorios

Producto	Pcs.	Contenidos							Código (inserción MZ)
		Brocas			Broca de corona	Puntas	Avellanador	Herramienta manual	
		Metal	Madera	Mampostería					
MAKPACK ★ ★ ★ ★  Los maletines de accesorios MAKPACK recopilan brocas, puntas y herramientas manuales en un maletín Makpack 1 adaptado.	65	✓	✓	✓	-	✓	✓	✓	B-69478 (inserción tipo C)
	69	✓	✓	✓	-	✓	✓	-	B-49638
	87	-	-	-	-	✓	-	✓	E-11542
	96	✓	✓	✓	-	✓	✓	✓	B-49725
	116	✓	✓	✓	-	✓	✓	✓	B-49884
	120	-	-	-	-	✓	-	✓	E-08713
MACCESS ★ ★ ★ ★  Los maletines de accesorios MACCESS recopilan accesorios de alta gama para un uso profesional.	34	✓	✓	✓	-	✓	✓	-	D-36980
	71	✓	✓	✓	-	✓	✓	✓	D-33691
	104	✓	✓	✓	-	✓	✓	✓	D-31778
	200	✓	✓	✓	✓	✓	✓	✓	D-37194
SQUARE ★ ★ ★  Para usuarios no profesionales.	17	✓	-	✓	-	✓	-	-	D-40200
	34	✓	✓	✓	-	✓	✓	-	B-68498



Sets de maletines de accesorios

Producto	Pcs.	Contenidos							Código (inserción MZ)
		Brocas			Broca de corona	Puntas	Avellanador	Herramienta manual	
		Metal	Madera	Mampostería					
SET DE ACCESORIOS ★ ★ ★   Sets de accesorios en distintos maletines y tamaños que incluyen brocas, brocas de corona, puntas, avellanadores y herramientas manuales.	60	✓	✓	✓	-	✓	✓	-	E-11829
	100	✓	✓	✓	✓	✓	✓	-	B-54520
	102	✓	✓	✓	-	✓	✓	-	B-68432
		✓	✓	✓	✓	✓	✓	✓	E-10730
	212	✓	✓	✓	✓	✓	✓	✓	E-06270
	256	✓	✓	✓	✓	✓	✓	✓	E-11689
HERRAMIENTA MANUAL ★ ★ ★  Estos sets contienen principalmente herramientas manuales. Debido a su peso, están cubiertos de plástico reforzado resistente a impactos o caídas.	76	-	-	-	-	✓	-	✓	E-10899
	87	-	-	-	-	✓	-	✓	E-08458
	120	-	-	-	-	✓	-	✓	E-06616
	221	-	-	-	-	✓	-	✓	E-10883
ESTUCHES SDS-PLUS ★ ★ ★ 	18	-	-	✓	-	✓	✓	-	E-07026
	29	✓	✓	✓	-	✓	-	-	E-07054
ESTUCHE ★ ★ ★ 	17	✓	✓	✓	-	-	-	-	D-74887
ESTUCHE ★ ★ ★ 	71	✓	✓	-	-	✓	-	-	B-50295



GAMA DE EXTERIORES
OUTDOORS



MEJORA TU EXPERIENCIA



XGT **40V** Li-ion
max

LXT
Litio-ion **EXTREMA TECNOLOGIA**

CXT

Batería



Baterías XGT, LXT, cargadores y compatibilidad de carga



CARGADOR DOBLE RÁPIDO

DC40RB
191N09-8



276€

CARGADOR RÁPIDO

DC40RA
191E07-8



171€

DC40RC
191M90-3



100€

Tiempo de carga



8,0 Ah



530€
BL4080F
191X65-8

76 min.

76 min.

170 min.

5,0 Ah



336€
BL4050F
191L47-8

50 min.

50 min.

85 min.

4,0 Ah



287€
BL4040
191B26-6

45 min.

45 min.

67 min.

2,5 Ah



226€
BL4025
191B36-3

28 min.

28 min.

38 min.

2,0 Ah



204€
BL4020
191L29-0

22 min.

22 min.

30 min.

18V Litio-Ion



DC40RA
191E07-8

171€

+



ADP10
191C10-7

71€

Tiempo de carga

6,0 Ah



248€
BL1860B
197422-4

40 min.

5,0 Ah



215€
BL1850B
197280-8

35* min.

4,0 Ah



182€
BL1840B
197265-4

29 min.

3,0 Ah



154€
BL1830B
197599-5

22 min.

2,0 Ah



121€
BL1820B
197254-9

24 min.

1,5 Ah



100€
BL1815N
196235-0

15 min.



64V Litio-Ion

Nueva batería de 64V y 4,0Ah válida para LM001J



401€
BL6440
191R06-8

Tiempo de carga

120 min.

DC64WA
191W19-9

166€**



**Precio del cargador. No incluye batería

* Solo baterías cuya primera letra de su identificativo sea "I" ó "J"

Baterías LXT, cargadores y compatibilidad de carga

 DC18RC 195584-2 CARGADOR RÁPIDO 120€	 DC18RD 196933-6 2 puertos CARGADOR DOBLE RÁPIDO 220€	 DC18RE 198720-9 2 puertos CXT/LXT CARGADOR DOBLE RÁPIDO 187€	 DC18SF 196426-3 Multicargador 4 puertos * Excepto BL1430A. 315€	 DC18SH 199687-4 Cargador 2 puertos 121€	 DC18SD 194533-6 81€	 DC18SE 194622-7 Automóvil 121€
---	--	--	---	---	--	--

18V Litio-Ion

		Tiempo de carga			
		De 1 a 2 baterías		De 2 a 4 baterías	
6,0 Ah	 248€ BL1860B 197422-4	55 min.	130 min.	260 min.	130 min.
5,0 Ah	 215€ BL1850B 197280-8	45 min.	110 min.	220 min.	110 min.
4,0 Ah	 182€ BL1840B 197265-4	36 min.	90 min.	180 min.	90 min.
3,0 Ah	 154€ BL1830B 197599-5	22 min.	60 min.	120 min.	60 min.
2,0 Ah	 121€ BL1820B 197254-9	24 min.	45 min.	90 min.	45 min.
1,5 Ah	 100€ BL1815N 196235-0	15 min.	30 min.	60 min.	30 min.

14,4V Litio-Ion

		Tiempo de carga			
		De 1 a 2 baterías		De 2 a 4 baterías	
4,0 Ah	 177€ BL1440 196388-5	36 min.	90 min.	90 min.	180 min.
3,0 Ah	 149€ BL1430B 197615-3	22 min.	60 min.	60 min.	120 min.
1,5 Ah	 118€ BL1415N 196875-4	15 min.	30 min.	30 min.	60 min.



Baterías Li-ion, CXT, cargadores y compatibilidad de carga

18V
Litio-Ion

1,5
Ah



77€ BL1815G
198186-3

2,0
Ah



80€ BL1820G
191N69-0

Para los modelos:
DF457D, HP457D, JV183D, TD127D y DMR106.

14,4V
Litio-Ion

1,5
Ah



66€ BL1415G
198192-8

2,0
Ah



69€ BL1420G
191N76-3

Para los modelos:
DF347D, HP347D, JV143D y DMR106.



57€ DC18WA
195423-6



35€ DC18WB
191W37-7

70/90
min.

*70min (1,5Ah) 90min (2,0Ah).

80/105
min.

*800min (1,5Ah) 105min (2,0Ah).

CXT
12V



120€

DC10SB
197363-4



82€

DC10WD
197343-0

4,0
Ah



97€
BL1041B 197406-2

60
min.

130
min.

2,0
Ah



75€
BL1021B 197396-9

30
min.

70
min.

10,8V
Litio-Ion



50€
DC10WA
194588-1

1,3
Ah



61€
BL1013 196066-7

50
min.

1,5
Ah



7,2V
Litio-Ion

56€
BL7015 198000-3



Adaptadores de corriente



Adaptador para
DMR100 / DMR102 DMR107
SE00000078

17,70€



Adaptador para
DMR106 / DMR108
DMR112

SE00000101

26€



Adaptador para
DMR200
DMR201

SE00000501

15,40€



Adaptador para
ADP07
DF001D

198363-7

13,50€



Adaptador para
DMR115

SE00000679

33€



Adaptador 12-24V
para DCW180

WL00000002

9,90€



Adaptador 220V
para DCW180

WL00000058

82€



Cargador DC4001
para PDC1200

191L00-4

196€

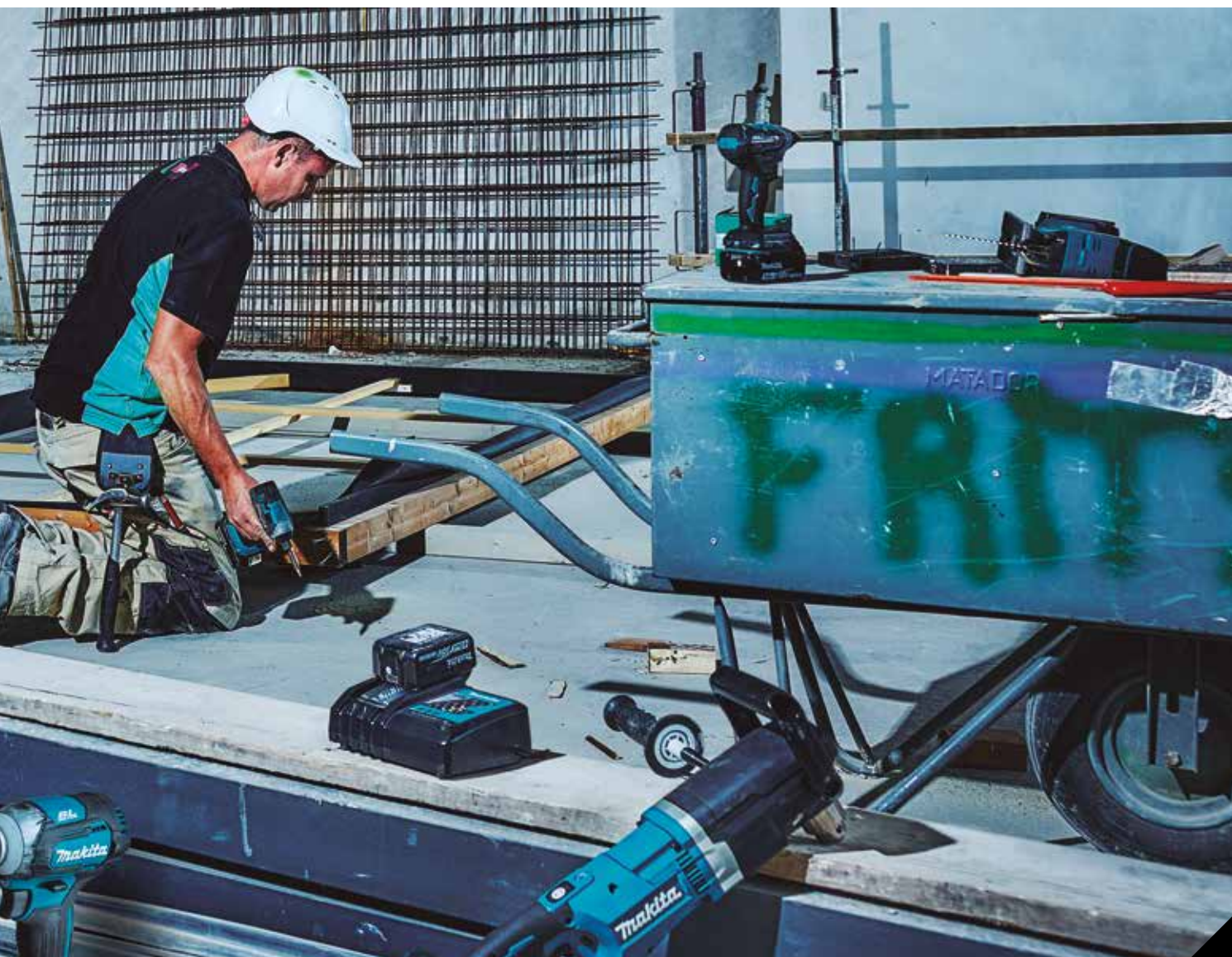

FUENTES DE ALIMENTACIÓN EXTERNAS

PDC1200

Nueva batería de mochila

18Vx2 LXT / 40V máx

33,5Ah

Tiene una capacidad de 1200 Wh, 33,5Ah y un voltaje 36V - 40V máx (aproximadamente).

Hasta 2,8 veces más de tiempo de duración que nuestra mochila portabaterías PDC01 cargada con 4 baterías 18V LXT 6,0Ah.

Compatible con: 18Vx2 LXT (adaptador opcional), conexión de alimentación directa de 36V y con 40V máx XGT (adaptador opcional).

Hasta 6 veces más de tiempo de trabajo con herramientas de 18Vx2 LXT y 6,0Ah.



IPX4



Cargador: DC4001
Tiempo de carga: 6 horas

Funciones y beneficios

- Con batería integrada de 40V máx.
- Alta capacidad: 1.200Wh. (aprox. 6 veces más tiempo de trabajo que con herramientas de 18Vx2 LXT con BL1860Bx2)



Altura ajustable

La posición del arnés se puede ajustar para mayor confort.



Arnés de extracción rápida

Se puede unir y soltar de la unidad de batería con un sólo movimiento.



Reflectores

Para una mayor visibilidad del usuario incluso en la oscuridad.

PDC1200A01 **1.984€***
PDC1200A02 **1.863€**
*Incluye adaptador 18Vx2

Mochila portabaterías

PDC01

IPX4



191C50-5
incluye adaptadores
18V y 18Vx2
4 baterías 5,0 Ah
Multicargador 2 puertos
1.901€

191A59-5
incluye adaptadores
18V y 18Vx2
1.020€

191A64-2
incluye adaptador
18Vx2
728€

Funciones y beneficios

- Con la posibilidad de conectar hasta 4 baterías LXT de 18V
- Alta capacidad: 432 Wh (con 4 baterías BL1860B)



Altura ajustable

La posición del arnés se puede ajustar para mayor confort.



Arnés de mochila

Se puede separar del compartimento de las baterías, convirtiéndose así en una fuente de alimentación fija.



Indicador de carga

Indica el estado de carga de cada batería con luces verdes. Con función de auto apagado.



Tipos de conexión y adaptadores

Conexión directa



40V máx



Adaptador 155€
191N62-4



18Vx2



Adaptador 180€
191J51-5



18V (sólo PDC01)



Adaptador 124€
191J50-7



Especificaciones

	PDC1200	PDC01
Capacidad	33,5 Ah	*
Almacenamiento	1.206 Wh	*
Número de células	100	-
Tiempo de carga (horas)	6	-
Dimensiones (L x An x Al)	sin arnés: 369x261x139 mm con arnés: 428x261x164 mm	sin arnés: 400x195x132 mm con arnés: 400x270x149 mm
Peso neto	sin arnés: 8,8 kg	sin baterías: 2,8 kg

* Dependerá de las baterías seleccionadas





Kits de fuentes de alimentación

- Kits de baterías: 2 baterías de 8,0Ah, multicargador rápido y maletín Makpac3.



191Y97-1 8,0 Ah



2x BL4080F
1x DC40RB
1x 821551-8

1.230€

- Kits de baterías: 2 baterías de 5,0Ah, multicargador rápido y maletín Makpac3.



191U13-9 5,0 Ah



2x BL4050F
1x DC40RB
1x 821551-8

859€

- Kits de baterías: 2 baterías de 4,0Ah, multicargador rápido y maletín Makpac3.



191U00-8 4,0 Ah



2x BL4040
1x DC40RB
1x 821551-8

761€

- Kits de baterías: Baterías de 4,0Ah y cargador rápido.



191J65-4 4,0 Ah



1x BL4040
1x DC40RA

413€

- Kits de baterías: 2 baterías de 4,0Ah, cargador rápido y maletín Makpac1.



191J97-1 4,0 Ah



2x BL4040
1x DC40RA
1x 821549-5

744€

- Kits de baterías: 2 baterías de 2,5Ah, cargador rápido y maletín Makpac1.



191J81-6 2,5 Ah



2x BL4025
1x DC40RA
1x 821549-5

540€

- Kits de baterías: Batería de 2,5Ah y cargador rápido.



191J39-5 2,5 Ah



2x BL4025
1x DC40RA

513€

- Kits de baterías: 2 baterías de 6,0Ah, multicargador rápido y maletín Makpac3.



198077-8 6,0 Ah



2x BL1860B
1x DC18RD
1x 821551-8

717€

- Kits de baterías: 2 baterías de 5,0Ah, multicargador rápido y maletín Makpac3.



197626-8 5,0 Ah



4x BL1850B
1x DC18RD
1x 821551-8

882€

Kits de fuentes de alimentación

- Kits de baterías: 2 baterías de 6,0Ah, cargador rápido y maletín Makpac1.
- Kits de baterías: 2 baterías de 6,0Ah y cargador rápido.
- Kits de batería: Batería de 5,0Ah, cargador rápido y maletín Makpac1.



198116-4 6,0 Ah



2x BL1860B
1x DC18RC
1x 821549-5

661€

199480-6 6,0 Ah



2x BL1860B
1x DC18RC

540€

198624-5 5,0 Ah



1x BL1850B
1x DC18RC
1x 821549-5

255€

Baterías, cargadores, Kits de baterías y adaptadores.

Descripción	Código	EAN	P.V.P (€)
Batería BL6440 64V - 4,0Ah	191R06-8		401,00
Batería BL4080F 40V - 8,0Ah XGT	191X65-8	0088381589116	530,00
Batería BL4050F 40V - 5,0Ah XGT	191L47-8	0088381580946	336,00
Batería BL4040 40V - 4,0Ah XGT	191B26-6	0088381557498	287,00
Batería BL4025 40V - 2,5Ah XGT	191B36-3	0088381556521	226,00
Batería BL4020 40V - 2,0Ah XGT	191L29-0	0088381574549	204,00
Batería BL1860B 18V - 6,0Ah LXT	197422-4	0088381464123	248,00
Batería BL1850B 18V - 5,0Ah LXT	197280-8	0088381459129	215,00
Batería BL1840B 18V - 4,0Ah LXT	197265-4	0088381459068	182,00
Batería BL1830B 18V - 3,0Ah LXT	197599-5	0088381464055	154,00
Batería BL1820B 18V - 2,0Ah LXT	197254-9	0088381459037	121,00
Batería BL1815N 18V - 1,5Ah LXT	196235-0	0088381471556	100,00
Batería BL1440 14,4V - 4,0Ah LXT	196388-5	0088381426671	177,00
Batería BL1430B 14,4V - 3,0 Ah LXT	197615-3	0088381465083	149,00
Batería BL1415N 14,4V - 1,5Ah LXT	196875-4	0088381443746	118,00
Batería BL1815G 18V - 1,5Ah	198186-3	0088381475891	77,00
Batería BL1820G 18V - 2,0Ah	191N69-0	0088381574884	80,00
Batería BL1415G 14,4V - 1,5Ah	198192-8	0088381475952	66,00
Batería BL1420G 14,4V - 2,0Ah	191N76-3	-	69,00
Batería BL1041B 12V máx - 4,0Ah CXT	197406-2	0088381461658	97,00
Batería BL1021B 12V máx - 2,0Ah CXT	197396-9	0088381459839	75,00
Batería BL1013 10,8V 1,3Ah	196066-7	0088381405423	61,00
Batería BL0715 7,2v litio	198000-3	0088381473392	56,00
DC40RB - Multicargador 2 puertos 40V Máx XGT	191N09-8	0088381579117	276,00
DC40RA - Cargador 40V Máx XGT	191E07-8	008838156354	171,00
DC40RC - Cargador 40V Máx XGT	191M90-3	0088381579261	100,00
DC18SF - Multicargador 4 puertos LXT	196426-3	0088381432979	315,00
DC18RD - Multicargador rápido 2 puertos LXT	196933-6	0088381444033	220,00
DC18SH - Multicargador 2 puertos LXT	199687-4	0088381542470	121,00
DC18RE - Multicargador 2 puertos 12V / 18V LXT	198720-9	0088381487924	187,00
DC18RC - Cargador rápido 18V LXT	195584-2	0088381373562	120,00
DC18SD - Cargador 18V LXT	194533-6	0088381345811	81,00
DC18SE - Cargador coche Litio	194622-7	0088381349673	121,00
DC18WA Cargador BL1411/1811	195423-6	0088381371575	57,00

Descripción	Código	EAN	P.V.P (€)
DC18WB Cargador 7,2V - 18V	191W37-7	0088381588645	35,00
DC10SB Cargador 12V	197363-4	0088381459563	120,00
DC10WD Cargador 12V	197343-0	0088381459211	82,00
Cargador DC64WA 64V	191W19-9		166,00
DC10WA Cargador 10,8V	194588-1	0088381348065	50,00
DC4001 Cargador	191L00-4	0088381570688	196,00
PDC01 - Mochila portabaterías con adaptador(x1) (x2)	191A59-5	0088381548588	1.020,00
PDC01- Mochila portabaterías con adaptador (x2)	191A64-2	0088381548632	728,00
PDC01 - Mochila portabaterías con 4 baterías BL1850B (5,0Ah) con adaptador(x1) (x2)	191C50-5	0088381553544	1.901,00
PDC1200A01 - Mochila portabaterías	PDC1200A01	0088381728621	1.984,00
PDC1200A02 - Mochila portabaterías	PDC1200A02	0088381728645	1.863,00
Kit fuente alimentación 8,0Ah 2 baterías BL4080F + DC40RB + Makpac3	191Y97-1	-	1.230,00
Kit fuente alimentación 6,0Ah 2 baterías BL1860B + DC18RC	198116-4	0088381474146	661,00
Kit fuente alimentación 6,0Ah BL1860B + DC18RD	198077-8	0088381474511	717,00
Kit fuente alimentación 5,0Ah 4 baterías BL1850B + DC18RD + Makpac3	197626-8	0088381463164	882,00
Kit fuente 40V máx 2,5Ah XGT 2 baterías BL4025 + DC40RA	191J39-5	0088381561006	513,00
Kit fuente 40V máx 4,0Ah XGT 2 Baterías BL4040 + DC40RA + Makpac1	191J97-1	0088381561389	744,00
Kit fuente 40V máx 2,5Ah XGT 2 Baterías BL4025 + DC40RA + Makpac1	191J81-6	0088381561228	540,00
Kit fuente 40V máx 5,0Ah XGT 2 Baterías BL4050F + DC40RB + Makpac3	191U13-9	0088381583039	859,00
Kit fuente 40V máx 4,0Ah XGT 2 Baterías BL4040 + DC40RB + Makpac3	191U00-8	0088381582902	761,00
Kit fuente 40V máx 4,0Ah XGT Batería BL4040 + DC40RA	191J65-4	0088381561068	413,00
Kit fuente alimentación 5,0Ah BL1850B + DC18RC + Makpac 1	198624-5		255,00
Kit fuente alimentación 6,0Ah 2 baterías BL1860B + DC18RC	199480-6	0088381537100	540,00
Adaptador ADP10 - 40V Máx / 18v XGT / LXT	191C10-7	0088381556422	71,00
Adaptador 383PCC0B11 - BMR100	SE00000078	0088381447829	17,70
Adaptador - BCF201ZW	TEB0000006	3240890380852	34,00
Adaptador - DMR106	SE00000101	0088381425162	26,00
Adaptador - DMR115	SE00000679	0088381588430	33,00
Adaptador 3A8A12C133B11 - DMR100	SE00000501	0088381534826	15,40
Adaptador ADP07 - DF001DW	198363-7	0088381525671	13,50
Adaptador 12-24V - DCW180	WL00000002		9,90
Adaptador 220V - DCW180	WL00000058	0088381591065	82,00

Adaptadores

• PDC01



191J50-7

• PDC01
• PDC1200



191J51-5

• PDC01
• PDC1200



191N62-4



Para	Descripción	Unds.	Código	EAN	P.V.P (€)
LXT	Adaptador simple LXT 18V	1	191J50-7	0088381560375	133,00
LXT	Adaptador doble LXT 18Vx2	1	191J51-5	0088381560382	193,00
XGT	Adaptador simple XGT 40Vmax.	1	191N62-4	0088381580342	166,00

Adaptador de batería para el cinturón BAP36N y BAP182

- Permite separar la batería de la herramienta y así reducir el peso de la máquina para menor fatiga en el brazo.

36V

18V x 2



* Adaptador no válido para BC231UD y UX361D.



18V Novedad



Modelo	Para	Descripción	Unds.	Código	EAN	P.V.P (€)
BAP36N *	36V	Permite separar la/s batería/s de la herramienta y así conseguimos reducir el peso de la misma.	1	195311-7	0088381363181	77,00
BAP182	18Vx2		1	197580-6	0088381463119	151,00
BAP18C **	18V		1	191M50-5	0088381571982	58,00

** Indicado para aspiradores de mano.

Convertidor de batería

- Con dos baterías de 18V (BL1860B, BL1850B, BL1840B, BL1830B) se pueden utilizar las máquinas de 36V.

BCV01 *

18V x 2



BCV03

18V x 2



* Adaptador no válido para BC231UD y UX361D.

Modelo	Para	Descripción	Unds.	Código	EAN	P.V.P (€)
BCV01 *	36V	Adaptador 2 baterías de 18V a una de 36V Maleta+cable+adaptador	1	195511-9	0088381371650	139,00
BCV03	36V	Adaptador 2 baterías de 18V a 36V Adaptador directo en la máquina	1	197214-1	0088381459013	123,00

Adaptadores USB



DEADP05

Para	Descripción	Unds.	Código	EAN	P.V.P (€)
LXT 18V	Adaptador para USB	1	DECADP05	-	32,00
CXT 12V	Adaptador para USB con gancho para cinturón	1	DEAADP06	0088381825108	31,00
CXT 12V	Adaptador para USB	1	DEAADP08	0088381853224	31,00
XGT 40V	Adaptador para USB	1	DEAADP001G	-	54,00

Adaptador para baterías Ni-Cd / Ni.Mh



Para	V	Unds.	Código	EAN	P.V.P (€)
Baterías Ni-Cd y Ni-MH	9,6 18V	1	193947-6	0088381188395	50,00

Conectores de batería para chaquetas



GM00001607



GM00001605



PE00000037



YL00000004

Modelos	Unds.	Código	EAN	P.V.P (€)	
Chaquetas ventiladas	LXT 18V	1	198634-2	0088381486675	49,00
	CXT 12V	1	198639-2	0088381486729	48,00
Chaquetas calefactables	LXT 18V	1	TD00000111		66,00
	CXT 12V	1	YL00000003	0088381537087	41,00

Protectores para llaves de impacto



Para	Unds.	Código	EAN	P.V.P (€)
DTW1001	1	413G40-5	0088381595070	33,00
TW001G	1	413G38-2	0088381595087	35,00

Protectores de batería anti-polvo y agua

- Diseñado para proteger la batería del polvo y agua en condiciones adversas.



Para	Válido para	Unds.	Código	EAN	P.V.P (€)
14,4V BL1430B BL1440B	DTD148	1	195797-5	0088381376525	49,00
18V BL1830B BL1840B BL1850B	DHP458	1	195798-3	0088381376532	51,00

Protector de batería

- Diseñado para proteger la batería contra golpes accidentales y humedad.



Para	Unds.	Código	EAN	P.V.P (€)
BL1830 BL1840 BL1850 BL1860	1	459938-0	-	8,20
BL1415	1	454407-6	-	5,00
BL1815 BL1820B	1	459937-2	-	6,60

Sistema AWS



El sistema AWS (Automatic Wireless System) nos permite conectar el aspirador en modo autoconexionado con las máquinas que dispongan de AWS, poniéndose en funcionamiento solo cuando accionamos la máquina sin necesidad de cables.



Descripción	Unds.	Código	EAN	P.V.P (€)
Dispositivo AWS conexión Bluetooth	1	198900-7	0088381497749	59,00

Filtro para chaquetas ventiladas



Modelos	Unds.	Código	EAN	P.V.P (€)
DFJ301Z DFJ201Z	1	GM00001499	0088381471299	25,00

Accesorios para pistola de silicona DCG180

A 196351-8



Despiece:

- Boquilla A (tipo cartucho) 454275-7
- Junta de boquilla A 454223-6
- Rack 42 142042-1
- Pistón A 142071-2

B 191P89-6 / 1911T4-0



Despiece:

- Boquilla B 141861-0
- Junta de boquilla B 318958-2
- Anillo de goma 424547-4
- Punta de boquilla 454226-0
- Rack 64 142042-9
- Pistón A (tipo cartucho) 142071-2
- Pistón B (tipo salchicha) 142072-0
- Pistón C (sellador a granel) 123221-8

C 197195-9



Despiece:

- Boquilla C 455951-6
- Junta de boquilla C 455952-4
- Junta de boquilla C (completa) 143223-8
- Pistón D (tipo cartucho) 143221-2
- Rack 53 143220-4



Capacidad	Tipo	Descripción	Unds.	Código	EAN	P.V.P (€)
300ml	A	Para colocar tubos de silicona de 300 ml	1	196351-8	0088381424271	46,00
400ml	B	Para colocar silicona en salchicha o a granel	1	191P89-6	0088381580915	95,00
600ml	B		1	1911T4-0	0088381486729	134,00
800ml	C	Para colocar tubos de silicona de 800 ml	1	197195-9	0088381458221	76,00

Boquilla de silicona. Para tipos B y C

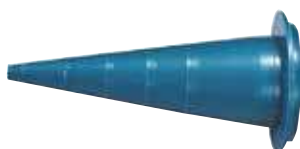

Tipo	Descripción	Unds.	Código	EAN	P.V.P (€)
B C	Boquilla de silicona reocortable	1	454226-0	0088381437080	4,10

Accesorios para remachadora



Set de mordazas para remachadoras



Descripción	Unds.	Código	EAN	P.V.P (€)
Set de mordazadas para DRV150	1	199731-7	0088381568647	15,40
Set de mordazadas para DRV250	1	199730-9	0088381568630	15,40

Boquillas para remaches DRV150 / DRV250



Descripción	Modelo	Unds.	Código	EAN	P.V.P (€)
2,4 mm	DRV150	1	199729-4	0088381567299	36,00
3,2 mm		1	199728-6	0088381567282	35,00
4,0 mm		1	191C04-2	0088381567275	17,70
4,8 mm		1	191C03-4	0088381567268	17,70
4,0 mm	DRV250	1	191F80-4	0088381567336	61,00
4,8 mm		1	191F79-9	0088381567329	29,00
6,0 mm		1	199725-2	0088381567312	29,00
6,4 mm		1	191F78-1	0088381567305	29,00

Accesorios para engrasadora DGP180



Descripción	Unds.	Código	EAN	P.V.P (€)
Depósito tipo B 450g	1	191A81-2	0088381558440	98,00
Depósito tipo B 400g	1	191B12-7	0088381558433	97,00
Depósito tipo A 400g	1	191F24-4	0088381558464	77,00
Depósito tipo A 450g	1	191F25-2	0088381558471	74,00



Descripción	Unds.	Código	EAN	P.V.P (€)
Manguera flexible 1.200 mm	1	191W58-9	-	45,00
Manguera flexible 600 mm	1	191A80-4	0088381558518	66,00



Descripción	Unds.	Código	EAN	P.V.P (€)
Adaptador de boquilla angular	1	191A77-3	0088381567213	78,00
Adaptador de boquilla con bloqueo	1	191A76-5	0088381567206	138,00



Descripción	Unds.	Código	EAN	P.V.P (€)
Set de adaptadores (3 piezas)	1	191A78-1	-	47,00



Sets de alambre para atadora de ferralla DTR180 y extensión de mango



Extensión de mango

- Extensión de mango para DTR180 indicado para reducir el esfuerzo y la fatiga en la espalda. También incluye guía acolchada para el antebrazo.



* Herramienta no incluida

Descripción	Unds.	Código	EAN	P.V.P (€)
Mango extensor	1	191M27-0	0088381572675	198,00

Accesorios para infladores



Descripción	Unds.	Código	EAN	P.V.P (€)
Set de alambre 50 rollos	1	199137-9	0088381533928	201,00



Descripción	Unds.	Código	EAN	P.V.P (€)
Set de alambre galvanizado 50 rollos	1	191A57-9	0088381547949	287,00



- 50 rollos de alambre de 100 metros cada uno.
- Diámetro del hilo 0,8mm.

Descripción	Unds.	Código	EAN	P.V.P (€)
Set alambre poliester 50 rollos	1	191J59-9	0088381560894	397,00



TE00000333



TE00000334



TE00000335



TE00000597

Descripción	Unds.	Código	EAN	P.V.P (€)
Boquilla para inflador <0,5 bar	1	TE00000333	0088381547918	0,85
Boquilla para inflador 0,7 bar	1	TE00000334	0088381547925	0,55
Boquilla para inflador 0,9 bar	1	TE00000335	0088381547932	0,60
Adaptador británico inflador	1	TE00000597	-	1,35

Accesorios para vibradores



Descripción	Unds.	Código	EAN	P.V.P (€)
Set eje flexible 32 - 1,2M VR001	1	1910E1-5	0088381592222	300,00
Set eje flexible 32 - 1,7M VR004	1	1910E2-3	0088381592239	316,00
Set eje flexible 32 - 2,4M VR001	1	1910C2-9	0088381592246	326,00
Set eje flexible 38 - 2,4M VR004	1	1910C4-5	0088381592260	310,00



Descripción	Unds.	Código	EAN	P.V.P (€)
Protector de batería	1	1910J1-0	-	89,00



ILUMINACIÓN



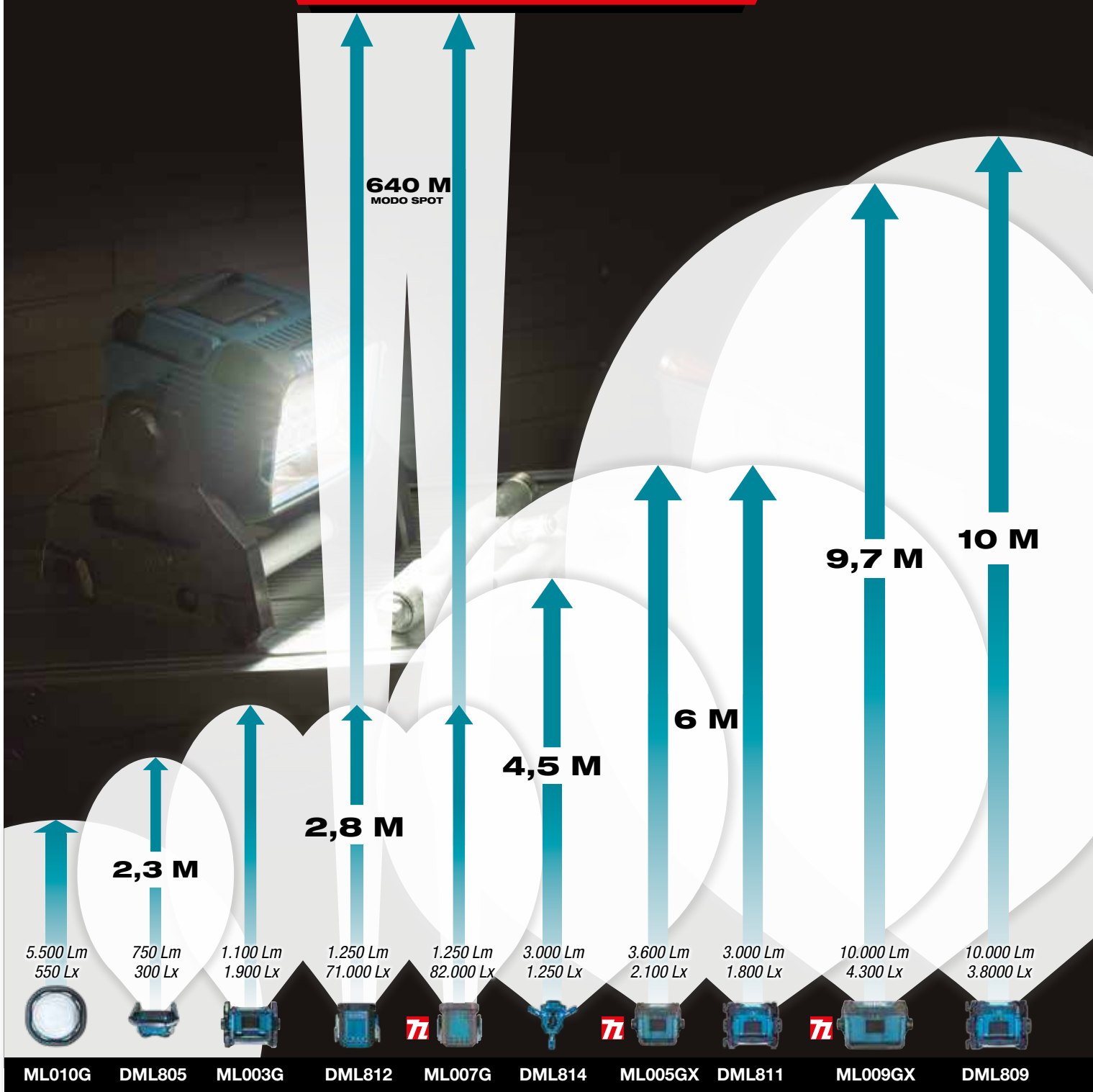



160 Lm
3.000 Lx

180 Lm
4.000 Lx

180 Lm
4.000 Lx

190 Lm
4.500 Lx

190 Lm
4.500 Lx

190 Lm
5.500 Lx

130 Lm
1.900 Lx

130 Lm
1.900 Lx

90 Lm
2.100 Lx

500 Lm
800 Lx

500 Lm
800 Lx

240 Lm
400 Lx

710 Lm
340 Lx

710 Lm
340 Lx

620 Lm
310 Lx

ML001G DEBDML815 DEBDML802 DEAML106 DEBML106 DEBDML808 DEBML105 ML002G DEAML104 DEBDML806 ML006GX DML816X DEBDML801



Linterna de área 5.500Lm - ML010G

- 3 ajustes de brillo: 5.500 / 3.000 / 1.500 Lm.
- 3 niveles de iluminancia: 550 / 280 / 130Lx. *
- Bloqueo de la tapa de la batería para proteger la batería del robo.
- Capaz de conectar hasta 8 unidades ML010 en serie.
- Alojamiento para dos baterías LXT.
- Certificación IP54 de resistencia al polvo y al agua. **
- Tiempo de iluminación: 6,5H en modo 360 con BL4040x2.
- AC/DC.



XGT 40V Li-ion max

18V LITHIUM-ION



*A 1m de distancia. ** Sólo con alimentación DC.

Dimensiones	Unds.	Código	EAN	P.V.P (€)
490 x 490 x 814mm	1	ML010G	-	950,00

Trípode regulable 3.000 Lm - DML814

- 3 ajustes de brillo: 3.000 / 1.700 / 900 Lm.
- 3 niveles de iluminancia: 1.250 / 750 / 400Lx. *
- 3 cabezales individuales giratorios.
- Luz LED blanca, ideal para trabajo.
- Los cierres tienen con un tornillo de ajuste.
- Tapa de batería con candado.
- Plegable en un tamaño compacto para un almacenamiento y transporte sencillo.
- Tiempo de iluminación: 3H en brillo alto con BL1850B.



18V LITHIUM-ION

Primer trípode de iluminación Makita



Dimensiones	Unds.	Código	EAN	P.V.P (€)
573 x 658 x 2.240mm	1	DML814	0088381728614	452,00

Nuevos focos de iluminación

XGT

LXT
LITHIUM-ION EXTREMA TECNOLOGIA



Foco de iluminación 10.000Lm - ML009GX

- 3 ajustes de brillo: 10.000 / 4.000 / 2.000 Lm.
- 3 niveles de iluminancia: 4.300 / 1.900 / 1.000 Lx. *
- Función de memoria en la configuración de brillo.
- Clasificación IP65 para resistencia al agua.
- Tiempo de iluminación: 2,4H en brillo alto con BL4040x2.



XGT 40V Li-ion max

18V LITHIUM-ION

Dimensiones	Unds.	Código	EAN	P.V.P (€)
248 x 386 x 305 mm	1	ML009GX	-	555,00



Dimensiones	Unds.	Código	EAN	P.V.P (€)
Tripode ML009GX	1	GM00002378	-	190,00

Foco de iluminación 1.100Lm - ML005GX

- 3 ajustes de brillo: 3.600 / 1.800 / 900 Lm.
- 3 niveles de iluminancia: 2.100 / 1.000 / 500 Lx. *
- Función de memoria en la configuración de brillo.
- Clasificación IP65 para resistencia al agua.
- Tiempo de iluminación: 3,5H en brillo alto con BL4040.



XGT 40V Li-ion max

18V LITHIUM-ION

Dimensiones	Unds.	Código	EAN	P.V.P (€)
248 x 309 x 296 mm	1	ML005GX	-	330,00



Dimensiones	Unds.	Código	EAN	P.V.P (€)
Difusor luz DML811	1	GM00002358	-	12,50

Luces LED de alta intensidad para un mayor rango.
Hasta 10 horas de iluminación continua.
Con una potencia de hasta 10.000 lúmenes.
Compatibles con baterías XGT y LXT

Foco de iluminación 1.100Lm - ML003G

- 2 ajustes de brillo: 1.100 / 450 Lm.
- 2 niveles de iluminancia: 500 / 200 Lx. *
- Función de memoria en la configuración de brillo.
- Clasificación IP65 para resistencia al agua.
- Tiempo de iluminación: 10H en brillo alto con BL4040.



Dimensiones	Unds.	Código	EAN	P.V.P (€)
249 x 298 x 280 mm	1	ML003GZ	0088381746632	231,00

Foco de iluminación 10.000Lm - DEADML809

- 3 ajustes de brillo: 10.000 / 4.000 / 2.000 Lm.
- 3 niveles de iluminancia: 3.800 / 1.500 / 800 Lx. *
- Clasificación IP65 para resistencia al agua.
- Tiempo de iluminación: 1,4H en modo alto con BL1850x2.



Dimensiones	Unds.	Código	EAN	P.V.P (€)
249 x 370 x 370mm	1	DEADML809	0088381888264	474,00



Descripción	Unds.	Código	EAN	P.V.P (€)
Difusor luz DML809	1	GM00002286	-	21,00
Tripode de altura ajustable 1,3 m a 2,0 m.		GM00002073	0088381548830	228,00

Foco de iluminación 750Lm - DEADML805

- 2 ajustes de brillo: 750 / 450 Lm.
- 2 niveles de iluminancia: 300 / 200 Lx. *
- Muy ligero. Asa a modo de gancho.
- Tiempo de iluminación: 8,5H modo alto con BL1850.



Dimensiones	Unds.	Código	EAN	P.V.P (€)
214 x 261 x 328 mm	1	DEADML805	0088381699303	186,00



Descripción	Unds.	Código	EAN	P.V.P (€)
Sujección gancho	1	GM00001396	0088381455688	22,00
Tripode	1	GM00002283	0088381579476	72,00
Difusor luz DML805	1	GM00002377	-	19,00
Lámina antideslumbrante	1	GM00002376	-	12,00

Foco de iluminación 3.000Lm - DML811

- 3 ajustes de brillo: 3.000 / 1.500 / 750 Lm.
- 3 niveles de iluminancia: 1.800 / 800 / 350 Lx. *
- Clasificación IP65 para resistencia al agua.
- Tiempo de iluminación: 3H en modo alto con BL1860B.
- Ajuste de ángulo de luz: de -30° a 210°.



Dimensiones	Unds.	Código	EAN	P.V.P (€)
249 x 302 x 271 mm	1	DML811	-	315,00



Descripción	Unds.	Código	EAN	P.V.P (€)
Difusor luz DML811	1	GM00002287	-	14,30



Foco de mano 1.250Lm - ML007G

- 3 ajustes de brillo: 600Lm proyector, 1.000Lm lupa y 1.250Lm mixto.
- 3 niveles de iluminancia: 82.000Lx proyector, 520Lx lupa y 60.000Lx mixto. *
- 4 modos: proyector, fijo, mixto y estroboscópico.
- Distancia de haz de hasta 640m en modo fijo.
- La cabeza de la linterna gira 90°.
- Tiempo de iluminación: 10H en modo proyector con BL4040.



Dimensiones	Unds.	Código	EAN	P.V.P (€)
330 x 120 x 133 mm	1	ML007G	0088381762342	182,00

Foco de mano 1.250Lm - DML812

- 3 ajustes de brillo: 600Lm proyector, 1.000Lm lupa y 1.250Lm mixto.
- 3 niveles de iluminancia: 71.000Lx proyector, 500Lx lupa y 51.000Lx mixto. *
- 4 modos: proyector, fijo, mixto y estroboscópico.
- Distancia de haz de hasta 640m en modo fijo.
- La cabeza de la linterna gira 90°.
- Tiempo de iluminación: 10H en modo proyector con BL1860B.



Dimensiones	Unds.	Código	EAN	P.V.P (€)
313 x 119 x 115 mm	1	DML812	-	159,00

Linterna de mano - DEBDML186

- 6 luces LED. 1 nivel de iluminancia: 500Lx. *
- Tiempo de iluminación: 50H con BL1830B.



Dimensiones	Unds.	Código	EAN	P.V.P (€)
151 x 81 x 61mm	1	DEBDML186	-	26,00



Linterna 190Lm - DEADML808

- 1 ajuste de brillo: 190Lm.
- Nivel de iluminancia: de 170 – 4.500Lx. *
- Cabezal pivotante de 12 posiciones de 0° a 170°.
- Con función de zoom que ajusta el rango de iluminación.
- Tiempo de iluminación: 32H con BL1860B.



Dimensiones	Unds.	Código	EAN	P.V.P (€)
297 x 79 x 119mm	1	DEBDML808	-	66,00

Linterna 190Lm - DEAML106

- 1 ajuste de brillo: 190Lm.
- Nivel de iluminancia: 170-4.500Lx. *
- Función zoom que ajusta el rango de iluminación.
- Accesorio magnético opcional.
- Reflector multifacético que se ilumina uniformemente.
- Tiempo de iluminación: 12H con BL1041B.



Dimensiones	Unds.	Código	EAN	P.V.P (€)
290 x 66 x 93mm	1	DEAML106	0088381853125	66,00

Linterna 160Lm - ML001G

- 1 ajuste de brillo: 160Lm.
- 1 nivel de iluminancia: 3.000Lx. *
- Cabezal pivotante de 12 posiciones de 0° a 170°.
- Tiempo de iluminación: hasta 55H con BL4040.

XST
40V^{max}
Li-ion



Dimensiones	Unds.	Código	EAN	P.V.P (€)
287 x 88 x 136mm	1	ML001G	-	54,00

Linterna 180Lm - DEBDML802

- 1 ajuste de brillo: 180Lm.
- 1 nivel de iluminancia: 4.000Lx. *
- Hasta 12 posiciones de cabezal.
- Tiempo de iluminación: hasta 23H con BL1850B.

18V
LITHI-ION



Dimensiones	Unds.	Código	EAN	P.V.P (€)
272 x 79 x 116mm	1	DEBDML802	0088381675758	59,00

Linterna 160Lm - DEBDML815

- 1 ajuste de brillo: 160Lm.
- 1 nivel de iluminancia: 3.000Lx. *
- Hasta 12 posiciones de cabezal.
- Tiempo de iluminación: hasta 45H con BL1850B.

18V
LITHI-ION



Dimensiones	Unds.	Código	EAN	P.V.P (€)
272 x 79 x 116mm	1	DEBDML815	-	42,00

Linterna 190Lm - DEBML105

- 1 ajuste de brillo: 190Lm.
- 1 nivel de iluminancia: 5.500Lx. *
- Hasta 12 posiciones del cabezal.
- Multirreflector, que controla la dirección.
- Cabezal compacto fabricado en aluminio.
- Tiempo de iluminación: 14H con BL1041B.

12V^{max}
LITHI-ION



Dimensiones	Unds.	Código	EAN	P.V.P (€)
268 x 66 x 93mm	1	DEBML105	0088381836180	62,00



Linterna de tubo 710Lm - ML002G

- 3 ajustes de brillo: 710Lm "modo 360°", 340Lm modo 180° y 130Lm modo linterna.
- 3 niveles de iluminancia: 340Lx modo 360°, 310Lx modo 180° y 1.900Lx modo linterna. *
- Interruptor con función de apagado automático.
- Con puerto USB integrado.
- Tiempo de iluminación: 16H de luz principal con BL4040B. (Sin uso del USB)



Dimensiones	Unds.	Código	EAN	P.V.P (€)
431 x 86 x 175mm	1	ML002G	-	126,00

Linterna de tubo 710Lm - DEAML104

- 3 ajustes de brillo: 710Lm modo 360°, 190Lm modo 180° y 130Lm modo linterna.
- 3 niveles de iluminancia: 340Lx modo 360°, 190Lx modo 180° y 1.900Lx modo linterna. *
- Puerto USB integrado. Gancho retráctil para ser colgada.
- Accesorio magnético opcional para operar con manos libres.
- Tiempo de iluminación: 17H de luz principal con BL1041B. (Sin uso del USB)



Dimensiones / Descripción	Unds.	Código	EAN	P.V.P (€)
414 x 66 x 132mm	1	DEAML104	0088381836173	109,00
Soporte magnético ML104	1	GM00001683	0088381479219	21,00

Linterna de tubo 620Lm - DEBDML806

- 3 ajustes de brillo: 620Lm modo 360°, 310Lm modo 180° y 90Lm modo linterna.
- 3 niveles de iluminancia: 310Lx modo 360°, 280Lx modo 180° y 2.100Lx modo linterna. *
- 3 opciones de uso: modo 360°, modo 180° y modo linterna.
- Tiempo de iluminación: 21H en luz principal con BL1850B.



Dimensiones	Unds.	Código	EAN	P.V.P (€)
365 x 78 x 119mm	1	DEBDML806	-	82,00



Linterna de faro 500Lm - ML006GX

- 3 ajustes de brillo: 500 / 250 / 100 Lm.
- 3 niveles de iluminancia: 800 / 400 / 180 Lx.*
- Cabezal con 7 posiciones.
- Gancho retráctil para ser colgada.
- Tiempo de iluminación: 20H en modo alto con BL4040.

XGT
40V
Li-ion
max



Dimensiones	Unds.	Código	EAN	P.V.P (€)
429 x 82 x 168 mm	1	ML006GX	-	90,00

Linterna de faro 500Lm- DML816X

- 3 ajustes de brillo: 500Lm / 250 / 100 Lm.
- 3 niveles de iluminancia: 800 / 400Lx / 180 Lx. *
- Temperatura de color de 5.000K.
- 7 posiciones del cabezal que gira a izquierda y derecha.
- Tiempo de iluminación: 17H en modo alto con BL1860B.

18V
LITHI-ION

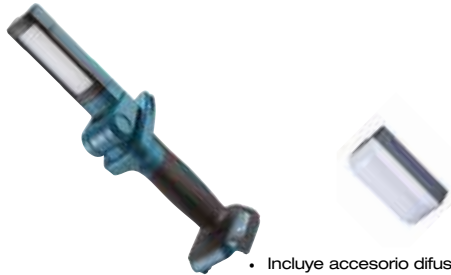

• Incluye accesorio difusor GM00001326

Dimensiones	Unds.	Código	EAN	P.V.P (€)
400 x 79 x 127mm	1	DML816X	-	82,00

Linterna de faro 240Lm - DEBDML801

- 2 ajustes de brillo: 240Lm / 120Lm.
- 2 niveles de iluminancia: 400 / 200Lx. *
- Plegable y con gancho giratorio 360°.
- 7 posiciones del cabezal que gira a izquierda y derecha.
- Tiempo de iluminación: 9H en modo full con BL1830B.

18V
LITHI-ION



Dimensiones	Unds.	Código	EAN	P.V.P (€)
380 x 79 x 116mm	1	DEBDML801	-	51,00

Linterna para cabeza 100Lm - DEBDML800

- 1 ajuste de brillo: 100Lm.
- 1 nivel de iluminancia: 2.000Lx. *
- 7 posiciones pivotantes.
- Clasificación IP65 para resistencia al agua.
- Tiempo de iluminación: hasta 20H con BL1830B.

18V
LITHI-ION



Dimensiones	Unds.	Código	EAN	P.V.P (€)
151 x 76 x 88mm	1	DEBDML800	-	49,00

Linterna de mano 100Lm - DEBML103

- 1 ajuste de brillo: 100Lm,
- 1 nivel de iluminancia: 240Lx. *
- Tiempo de iluminación: 28H con BL1041B.

12Vmax
LITHI-ION



Dimensiones	Unds.	Código	EAN	P.V.P (€)
87 x 64 x 73mm	1	DEBML103	0088381818636	30,00



TABLA COMPARATIVA DE ILUMINACIÓN

	Modelo	XGT	LXT	CXT	DC IAC	Modos / iluminación	Modos / iluminancia
	ML010G	✓	✓	-	✓	alto / medio / bajo 5.500 / 3.000 / 1.500Lm	alto / medio / bajo 550 / 300 / 150Lx a 1m de distancia
	DML814	-	✓	-	-	alto / medio / bajo 3.000 / 1.700 / 900Lm	alto / medio / bajo 1250 / 750 / 400Lx a 1m de distancia
	ML009GX	✓	✓	-	-	alto / medio / bajo 10.000 / 4.000 / 2.000Lm	alto / medio / bajo 4.300 / 1.900 / 1.000Lx a 1m de distancia
	ML005G	✓	✓	-	-	alto / medio / bajo 3.600 / 1.800 / 900Lm	alto / medio / bajo 2.100 / 1.000 / 500Lx
	ML003G	✓	✓	-	-	alto / bajo 1.100 / 450Lm	alto / bajo 500 / 200Lx a 1m de distancia
	DML809	-	✓	-	✓	alto / medio / bajo 10.000 / 4.000 / 2.000Lm	alto / medio / bajo 3.800 / 1.500L / 800Lx a 1m de distancia
	DML805	-	✓	-	✓	alto / bajo 750 / 450Lm	alto / bajo 300 / 200Lx a 1m de distancia
	DML811	-	✓	-	✓	alto / medio / bajo 3.000 / 1.500 / 750Lm	alto / medio / bajo 1.800 / 800 / 350Lx a 1m de distancia
		DML812	-	✓	-	-	Proyector / Lupa / Mixto 600 / 1.000 / 1.250Lm
ML007G		✓	-	-	-	Proyector / Lupa / Mixto / Estroboscópico 600 / 1.000 / 1250Lm	Proyector / Lupa / Mixto / Estroboscópico 82.000 / 520 / 60.000Lx
	ML001G	✓	-	-	-	160Lm	3.000Lx a 1m de distancia
	DML815	-	✓	-	-	160Lm	3.000Lx a 1m de distancia
	ML105	-	-	✓	-	190Lm	5.500Lx a 1m de distancia
	DML808	-	✓	-	-	190Lm	zoom 170 / 4.500Lx a 1m de distancia
	DML802	-	✓	-	-	180Lm	4.000Lx a 1m de distancia
	ML106	-	-	✓	-	190Lm	zoom 170 / 4.500Lx a 1m de distancia
	ML002G	✓	-	-	-	360° / 180° / linterna 710 / 340 / 130Lm	360° / 180° / linterna 340 / 310 / 1.900Lx a 50cm de distancia
	ML104	-	-	✓	-	Luz principal / secundaria 710 / 130Lm	Luz principal / secundaria 1.900 / 340Lx
	ML006GX	✓	-	-	-	alto / medio / bajo 500 / 250 / 100Lm	alto / medio / bajo 800 / 400 / 180Lx a 1 metro de distancia
	DML816X	-	✓	-	-	alto / medio / bajo 500 / 250 / 100Lm	alto / medio / bajo 800 / 400 / 180Lx a 1 metro de distancia
	DML806	-	✓	-	-	Luz principal / secundaria 620 / 310Lm	Luz principal / secundaria 310 / 280Lx
	DML801	-	✓	-	-	240Lm	Luz principal / secundaria 400 / 200Lx a 0,5m de distancia
	DML800	-	✓	-	-	100Lm	-
	ML103	-	-	✓	-	100Lm	-
	DML186	-	✓	-	-	6 LEDs	500Lx a 1 metro de distancia

SDS - PLUS 

SDS - MAX 

Makita Hexagonal 17mm 

Makita Hexagonal 19mm 

Makita Hexagonal 21mm 

Makita Hexagonal 28,6mm 

Makita Hexagonal 30mm 

B Hexagonal 19mm 

K Hexagonal 21mm 

Perforación y Percusión

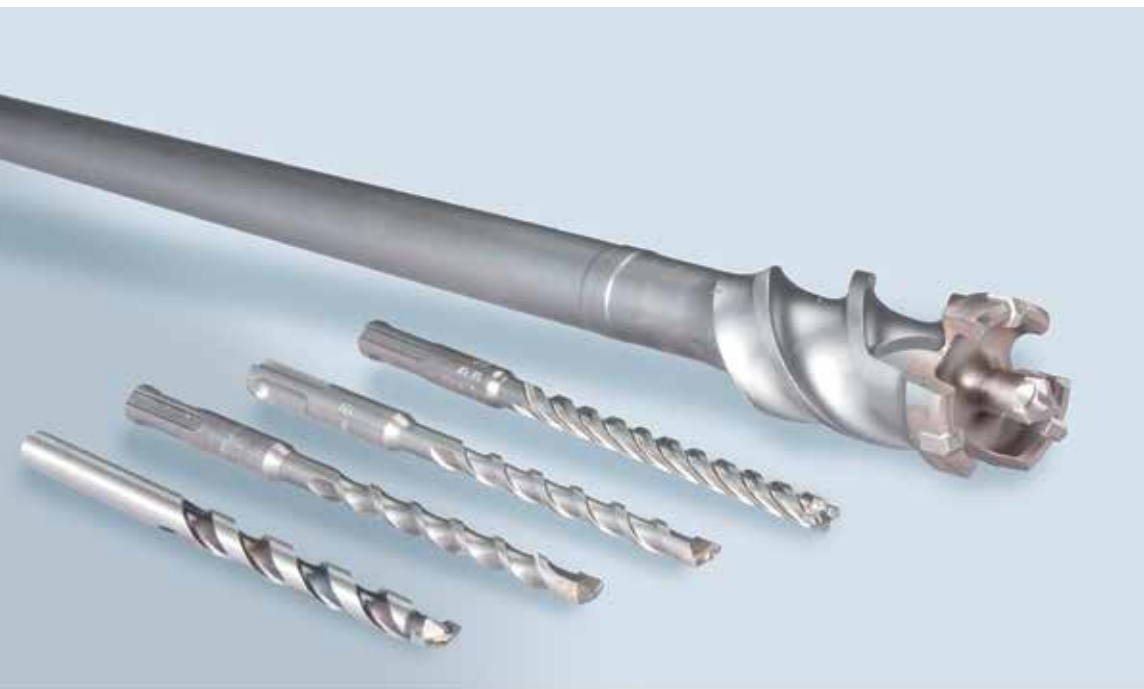

MAK 4



MEMES



Brocas SDS-PLUS **NEMESIS II**

La espiral

Resuelve problemas

Nota: Cuando encontramos varillas en el hormigón armado no hay que apretar. Dejar que la broca vaya cortando con una ligera presión.

Su diseño en espiral de cuatro salidas asegura que la carga de perforación se distribuya uniformemente a lo largo del eje de la broca. El acero de alta calidad y el tratamiento especial de la superficie garantizan la resistencia de la broca.

4 CORTES



4 x 90°, la broca corta de manera uniforme el metal y no se bloquea con las varillas de acero reforzado.



Núcleo de la espiral mejorado. Garantiza bajas vibraciones y una excepcional resistencia a la rotura.



La punta de centrado facilita la perforación del material con una precisión milimétrica.



El diseño simétrico de las 4 espirales aseguran que el desgaste sea bajo y uniforme.



La amplia geometría de las espirales permite un óptimo transporte del polvo del taladrado.

Brocas de 5 a 16mm.



Ø (mm)	Largo (mm)	Long. útil (mm)	Unds.	Código	EAN	P.V.P. (€)
5	115	50	1	B-57897	0088381520782	5,30
5	165	100	1	B-57906	0088381520799	5,60
5	215	150	1	B-57912	0088381520805	8,60
5	265	200	1	B-57928	0088381520812	8,90
5,5	115	50	1	B-57940	0088381520836	5,30
5,5	165	100	1	B-57956	0088381520843	5,60
6	115	50	1	B-57962	0088381520850	5,30
6	165	100	1	B-57978	0088381520867	5,60
6	215	150	1	B-57984	0088381520874	7,20
6	265	200	1	B-57990	0088381520881	8,60
6	315	250	1	B-58001	0088381520898	11,90
6,5	165	100	1	B-58023	0088381520911	7,50
6,5	215	150	1	B-58039	0088381520928	9,70
6,5	265	200	1	B-58045	0088381520935	12,20
6,5	315	250	1	B-58051	0088381520942	14,80
7	115	50	1	B-58067	0088381520959	6,70
7	165	100	1	B-58073	0088381520966	7,50
7	215	150	1	B-58089	0088381520973	10,90
8	115	50	1	B-58095	0088381520980	6,10
8	165	100	1	B-58104	0088381520997	6,40
8	215	150	1	B-58110	0088381521000	7,50
8	265	200	1	B-58126	0088381521017	8,90
8	315	250	1	B-58132	0088381521024	12,20
8	465	400	1	B-58154	0088381521048	19,50
9	165	100	1	B-58176	0088381521062	7,00
10	115	50	1	B-58198	0088381521086	6,40
10	165	100	1	B-58207	0088381521093	7,20
10	215	150	1	B-58213	0088381521109	8,10
10	265	200	1	B-58229	0088381521116	9,50
10	315	250	1	B-58235	0088381521123	12,30
10	455	390	1	B-58257	0088381521147	21,00
10	600	540	1	B-58263	0088381521154	28,00
10	1000	940	1	B-58279	0088381521161	67,00
11	160	100	1	E-14495	0088381594097	8,20
11	210	160	1	E-14504	0088381594103	9,90
11	260	210	1	E-14510	0088381594110	11,60
11	310	260	1	E-14526	0088381594127	16,00
12	160	110	1	E-14532	0088381594134	7,70

Brocas de 18 a 32mm.



Ø (mm)	Largo (mm)	Long. útil (mm)	Unds.	Código	EAN	P.V.P. (€)
12	210	160	1	E-14548	0088381594141	9,40
12	260	210	1	E-14554	0088381594158	10,50
12	310	260	1	E-14560	0088381594165	14,90
12	450	400	1	E-14576	0088381594172	22,00
12	600	550	1	E-14582	0088381594189	28,00
12	1000	950	1	B-58388	0088381521277	67,00
14	160	110	1	E-14635	0088381594233	11,00
14	210	160	1	E-14641	0088381594240	14,90
14	260	210	1	E-14657	0088381594257	17,10
14	310	260	1	E-14663	0088381594264	18,20
14	450	400	1	E-14679	0088381594271	24,00
14	600	550	1	E-14685	0088381594288	31,00
14	1000	950	1	B-58497	0088381521383	70,00
15	160	110	1	E-14691	0088381594295	17,10
15	210	160	1	E-14700	0088381594301	19,30
15	260	210	1	E-14716	0088381594318	21,00
15	450	400	1	E-14722	0088381594325	28,00
16	160	110	1	E-14738	0088381594332	17,70
16	210	160	1	E-14744	0088381594349	20,00
16	260	210	1	E-14750	0088381594356	22,00
16	310	260	1	E-14766	0088381594363	25,00
16	450	400	1	E-14772	0088381594370	31,00
16	600	550	1	E-14788	0088381594387	39,00
16	1000	950	1	B-58609	0088381521499	80,00
18	250	200	1	B-58615	0088381521505	29,00
18	450	400	1	B-58621	0088381521512	33,00
20	250	200	1	B-58637	0088381521529	32,00
20	450	400	1	B-58659	0088381521543	39,00
22	250	200	1	B-58665	0088381521550	36,00
22	450	400	1	B-58687	0088381521574	48,00
24	250	200	1	B-58693	0088381521581	46,00
24	450	400	1	B-58702	0088381521598	52,00
25	250	200	1	B-58718	0088381521604	46,00
25	450	400	1	B-58724	0088381521611	58,00
28	250	200	1	B-58746	0088381521635	52,00
28	450	400	1	B-58752	0088381521642	67,00
30	250	200	1	B-58768	0088381521659	59,00
30	450	400	1	B-58774	0088381521666	74,00
32	450	400	1	B-58780	0088381521673	95,00

* A partir de 18mm las brocas son de 3 piezas de carburo.

Gama de brocas SDS-V-PLUS MAK4.

Para martillos SDS-PLUS. Brocas con cabeza de 4 puntas.

Puede taladrar en hormigón armado. Taladros más PRECISOS que con las brocas de 2 puntas.

Indicado para todo tipo de trabajos donde se utiliza martillos ligeros SDS-PLUS.



Brocas de 5 a 25mm.



Ø (mm)	Largo (mm)	Long. Útil (mm)	Unds.	Código	EAN	P.V.P. (€)
5	110	50	1	B-68127	0088381544696	2,80
5	160	100	1	B-68133	0088381544702	2,80
6	110	50	1	B-62496	0088381529938	3,40
6	160	100	1	B-62505	0088381529945	3,40
6	210	150	1	B-62511	0088381529952	4,00
6	260	200	1	B-62527	0088381529969	4,30
8	110	50	1	B-62608	0088381530040	4,10
8	160	100	1	B-62614	0088381530057	4,10
8	210	150	1	B-62620	0088381530064	4,70
8	260	200	1	B-62636	0088381530071	5,20
8	310	250	1	B-62642	0088381530088	5,60
10	110	50	1	B-62664	0088381530101	5,50
10	160	100	1	B-62670	0088381530118	5,50
10	210	150	1	B-62686	0088381530125	6,00
10	260	200	1	B-62692	0088381530132	6,60
10	310	250	1	B-62701	0088381530149	6,90
12	160	100	1	B-62739	0088381530170	7,40
12	210	150	1	B-62745	0088381530187	8,00
12	260	200	1	B-62751	0088381530194	8,60
12	310	250	1	B-62767	0088381530200	8,80
12	350	290	1	B-62773	0088381530217	9,90
14	160	100	1	B-62795	0088381530231	11,00
14	210	150	1	B-62804	0088381530248	11,60
14	260	200	1	B-62810	0088381530255	12,10
14	310	250	1	B-62826	0088381530262	12,40
14	350	290	1	B-62832	0088381530279	12,70
16	160	100	1	B-62854	0088381530293	13,20
16	210	150	1	B-62860	0088381530309	13,80
16	260	200	1	B-62876	0088381530316	14,40
16	310	250	1	B-62882	0088381530323	15,70
16	350	290	1	B-62898	0088381530330	16,30
18	260	200	1	B-68177	0088381544740	21,00
18	460	400	1	B-68236	0088381544801	26,00
20	260	200	1	B-68183	0088381544757	27,00
20	460	400	1	B-68242	0088381544818	31,00
22	260	200	1	B-68199	0088381544764	33,00
22	460	400	1	B-68258	0088381544825	41,00
25	260	200	1	B-68208	0088381544771	42,00
25	460	400	1	B-68264	0088381544832	45,00



Brocas V-PLUS MAK 2



• **Potencia de rotura.**

Efecto demolición.
Produce microrroturas en el taladrado.
Genera mayor velocidad de taladrado.

• **Reduce la fricción en los laterales para aumentar la velocidad.**



• **Duración en hormigón armado.**

Mayor duración (+35%).
Previene daños en la pastilla cuando golpea en varilla.
Reduce la probabilidad de enganche durante el taladrado.

• **Flauta KVS.**

Geometría cónica de la flauta.
De este modo ofrece gran velocidad y resistencia a la rotura.

• **Pastilla de centrado.**

• **Gran durabilidad.**

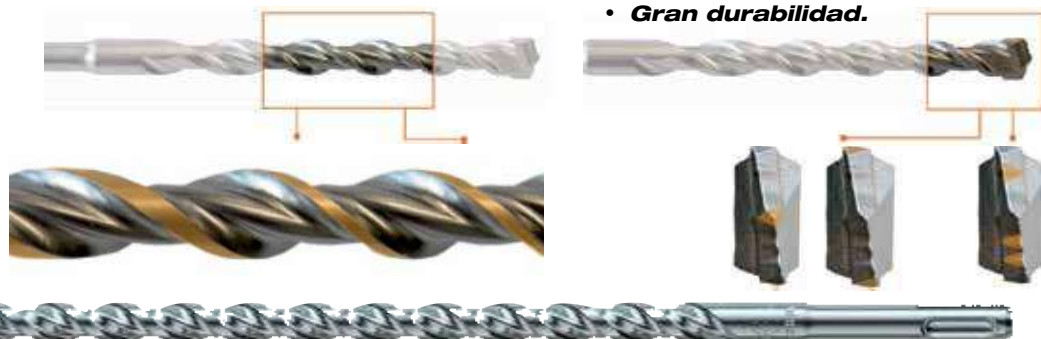

Ø (mm)	Largo (mm)	Long. útil (mm)	Unds.	Código	EAN	P.V.P. (€)
3,5	110	50	1	E-10665	0088381580434	6,10
4	110	50	1	B-47232	0088381454315	3,40
4	160	100	1	B-47248	0088381454322	3,90
4,5	160	100	1	E-10671	0088381580441	6,10
5	110	50	1	B-46492	0088381452427	2,80
5	160	100	1	B-46501	0088381452434	3,05
5,5	110	50	1	B-47298	0088381454377	2,80
5,5	160	100	1	B-47307	0088381454384	3,60
5,5	210	150	1	B-47313	0088381454391	6,40
6	110	50	1	B-46517	0088381452441	2,80
6	160	100	1	B-46523	0088381452458	2,80
6	210	150	1	B-47341	0088381454421	4,20
6	260	200	1	B-47357	0088381454438	5,30
6,5	110	50	1	B-47385	0088381454469	3,05
6,5	160	100	1	B-47391	0088381454476	3,60
6,5	210	150	1	B-47400	0088381454483	4,70
6,5	260	200	1	B-47416	0088381454490	6,40
7	110	50	1	B-47438	0088381454513	3,05
7	160	100	1	B-47444	0088381454520	3,40
7	210	150	1	B-47450	0088381454537	5,00
8	110	50	1	B-46539	0088381452465	3,05
8	160	100	1	B-46545	0088381452472	3,40
8	210	150	1	B-47472	0088381454551	4,40
8	260	200	1	B-47488	0088381454568	5,60
8	400	340	1	B-47503	0088381454582	10,50
8	600	540	1	B-47525	0088381454605	15,60
9	160	100	1	B-47531	0088381454612	4,20
9	210	150	1	B-47547	0088381454629	5,60
9,5	160	100	1	B-47553	0088381454636	4,70
10	110	50	1	B-46551	0088381452489	3,60
10	160	100	1	B-46567	0088381452496	3,90
10	210	150	1	B-47569	0088381454643	5,20
10	260	200	1	B-47575	0088381454650	6,10
10	310	250	1	B-47581	0088381454667	7,00
10	450	390	1	B-47606	0088381454681	11,70

Ø (mm)	Largo (mm)	Long. útil (mm)	Unds.	Código	EAN	P.V.P. (€)
10	600	540	1	B-47612	0088381454698	16,10
10	1000	940	1	B-47634	0088381454711	41,00
11	160	110	1	B-47640	0088381454728	5,80
11	210	160	1	B-47656	0088381454735	6,40
11	260	210	1	B-47662	0088381454742	7,80
12	160	110	1	B-46573	0088381452502	4,70
12	210	160	1	B-47684	0088381454766	5,80
12	260	210	1	B-47690	0088381454773	7,20
12	310	260	1	B-47709	0088381454780	9,20
12	450	400	1	B-47721	0088381454803	12,80
12	600	550	1	B-47737	0088381454810	16,70
12	1000	950	1	B-47759	0088381454834	44,00
13	160	110	1	B-47765	0088381454841	5,80
13	210	160	1	B-47771	0088381454858	6,70
13	260	210	1	B-47787	0088381454865	7,80
13	310	260	1	B-47793	0088381454872	10,00
14	160	110	1	B-46589	0088381452519	6,40
14	210	160	1	B-47802	0088381454889	7,20
14	260	210	1	B-47818	0088381454896	8,90
14	310	260	1	B-47824	0088381454902	10,00
14	450	400	1	B-47830	0088381454919	15,60
14	600	550	1	B-47846	0088381454926	18,40
14	1000	950	1	B-47852	0088381454933	45,00
15	160	110	1	B-47868	0088381454940	8,10
15	210	160	1	B-47874	0088381454957	9,40
15	260	210	1	B-47880	0088381454964	10,30
15	450	400	1	B-47896	0088381454971	16,20
16	160	110	1	B-47905	0088381454988	7,80
16	210	160	1	B-47911	0088381454995	9,50
16	310	260	1	B-47933	0088381455015	12,30
16	450	400	1	B-47949	0088381455022	18,40
16	600	550	1	B-47955	0088381455039	22,00
16	800	750	1	B-47961	0088381455046	33,00
16	1000	950	1	B-47977	0088381455053	51,00
17	210	160	1	B-47983	0088381455060	14,40

Brocas StandMak para martillos SDS-PLUS



Ø (mm)	Largo (mm)	Long. útil (mm)	Unds.	Código	EAN	P.V.P. (€)
3,5	110	50	1	D-15665	0088381170079	1,25
4	110	50	1	D-00016	0088381169004	1,30
5	110	50	1	D-00022	0088381169011	1,30
5	160	100	1	D-00038	0088381169028	1,30
5,5	110	50	1	D-00044	0088381169035	1,30
5,5	160	100	1	D-16106	0088381187381	1,30
6	110	50	1	D-00050	0088381169042	1,30
6	160	100	1	D-00066	0088381169059	1,30
6	210	150	1	D-00072	0088381169066	1,60
6,5	110	50	1	D-00088	0088381169073	1,30
6,5	160	100	1	D-00094	0088381169080	1,30
7	110	50	1	D-00103	0088381169097	1,30
7	160	100	1	D-00119	0088381169103	1,30
8	110	50	1	D-00125	0088381169110	1,30
8	160	100	1	D-00131	0088381169127	1,30
8	210	150	1	D-00147	0088381169134	1,60
8	260	200	1	D-00153	0088381169141	2,00
9	160	100	1	D-08056	0088381182379	1,60
9	210	150	1	D-00169	0088381169158	1,60
9,5	210	150	1	D-03274	0088381173520	1,60
10	160	100	1	D-00175	0088381169165	1,60
10	210	150	1	D-00181	0088381169172	1,95
10	260	200	1	D-00197	0088381169189	1,95
10	310	250	1	D-00206	0088381169196	2,55
10	460	400	1	D-17538	0088381196574	4,50
12	160	100	1	D-00228	0088381169219	1,60
12	210	150	1	D-00234	0088381169226	1,95
12	260	200	1	D-00240	0088381169233	1,95
12	460	400	1	D-16271	0088381187558	4,90
13	160	100	1	D-00256	0088381169240	1,85
13	350	290	1	D-16128	0088381187404	2,95
14	160	100	1	D-00262	0088381169257	2,00
14	260	200	1	D-00278	0088381169264	2,60
14	460	400	1	D-17544	0088381196581	5,20
16	210	150	1	D-00290	0088381169288	3,70
16	310	250	1	D-00309	0088381169295	4,50
16	460	400	1	D-16287	0088381187565	6,20
18	210	150	1	D-00321	0088381169318	3,60
18	300	240	1	D-00337	0088381169325	4,60
18	460	400	1	D-17566	0088381196604	7,20
20	210	150	1	D-00359	0088381169349	4,50
20	310	250	1	D-00365	0088381169356	7,40
20	460	400	1	D-15235	0088381186339	7,70
22	260	200	1	D-00371	0088381169363	5,90

Ø (mm)	Largo (mm)	Long. útil (mm)	Unds.	Código	EAN	P.V.P. (€)
22	310	250	1	D-08062	0088381182386	7,10
22	460	400	1	D-15241	0088381186346	8,50
24	460	400	1	D-16302	0088381187589	9,70
25	260	200	1	D-00387	0088381169370	7,70
25	310	250	1	D-08517	0088381182454	9,10
25	460	400	1	D-15257	0088381186353	11,10
26	260	200	1	D-00393	0088381169387	10,50
26	460	400	1	D-15263	0088381186360	12,40
28	460	400	1	D-16318	0088381187596	17,60
30	460	400	1	D-17572	0088381196611	21,00

Brocas StandMak para martillos SDS-PLUS

• **Cajas de 25 unidades.**



* Presentadas en caja de cartón. Brocas sueltas.

Ø (mm)	Largo (mm)	Long. útil (mm)	Unds.	Código	EAN	P.V.P. (€)
5	110	50	25	D-01155-25	0088381170598	23,00
6	110	50	25	D-01161-25	0088381170604	25,00
6	160	100	25	D-01177-25	0088381170611	30,00
8	160	100	25	D-01183-25	0088381170628	30,00
8	210	150	25	D-01199-25	0088381170635	37,00
10	160	100	25	D-01208-25	0088381170642	30,00
10	210	150	25	D-03707-25	0088381173995	41,00
12	160	100	25	D-03713-25	0088381174008	36,00
12	210	150	25	D-03729-25	0088381174015	41,00



Estuches y maletines de brocas

SDS-PLUS Némesis (7 piezas)



NEMESIS II



SDS-V-PLUS (13 piezas)



MAK 4



Ø (mm)	Largo (mm)	Long. útil (mm)	Unds.	Código	EAN	P.V.P. (€)
5	110	50	1	E-14928	0088381594523	51,00
6	110	50	1			
8	110	50	1			
6	160	100	1			
8	160	100	1			
10	160	100	1			
12	160	100	1			

Ø (mm)	Largo (mm)	Long. útil (mm)	Unds.	Código	EAN	P.V.P. (€)
6	110	50	1	B-64674	0088381535762	94,00
6	160	100	1			
7	110	50	1			
7	160	100	1			
8	110	50	1			
8	160	100	1			
10	110	50	1			
10	160	100	1			
12	160	100	1			
14	160	100	1			
16	160	100	1			
Puntero 250 mm			1			
Cinzel 20 x 250 mm			1			



SDS-PLUS Némesis (3 piezas)



NEMESIS II



Ø (mm)	Largo (mm)	Long. útil (mm)	Unds.	Código	EAN	P.V.P. (€)
6	160	100	1	B-59075	0088381521963	21,00
8	160	100	1			
10	160	100	1			

SDS-V-PLUS (5 piezas)



MAK 2



Ø (mm)	Largo (mm)	Long. útil (mm)	Unds.	Código	EAN	P.V.P. (€)
5	110	50	1	B-49052	0088381457460	15,60
6	110	50	1			
8	110	50	1			
6	160	100	1			
8	160	100	1			

V-PLUS (7 piezas)



MAK 2



Ø (mm)	Largo (mm)	Long. útil (mm)	Unds.	Código	EAN	P.V.P. (€)
5	110	50	1	B-49046	0088381457453	31,00
6	110	50	1			
8	110	50	1			
6	160	100	1			
8	160	100	1			
10	160	100	1			
12	160	100	1			

SDS-PLUS StandMak



Ø (mm)	Largo (mm)	Long. útil (mm)	Unds.	Código	EAN	P.V.P. (€)
6,5	160	100	1	D-74728	0088381589291	8,80
8	160	100	1			
10	160	100	1			
12	160	100	1			
5	110	50	1	D-74136	0088381587174	8,80
6	160	100	1			
8	160	100	1			
10	160	100	1			

Estuche de brocas para hormigón / ladrillo



Ø (mm)	Largo (mm)	Unds.	Código	EAN	P.V.P. (€)
6-8-10-12	160	1	D-74756	0088381590181	9,40

Set brocas para taladros SDS-PLUS 4pcs



Estuche de brocas SDS-PLUS



Ø (mm)	Largo (mm)	Unds.	Código	EAN	P.V.P. (€)
6,8(x2) y 10(x2)	110/160	1	B-54704	0088381478427	12,50

Expositor de cartón con 12 estuches de 4 piezas cada uno.

Ø (mm)	Largo (mm)	Long. útil (mm)	Unds.	Código	EAN	P.V.P. (€)
5	110	100	1	E-13596-12	0088381592055	149,00
6	160	100	1			
8	160	100	1			
10	160	100	1			



Estuche StandMak para martillos SDS-PLUS (5 piezas)



Ø (mm)	Largo (mm)	Long. útil (mm)	Unds.	Código	EAN	P.V.P. (€)
5	110	50	1	D-00795	0088381171182	5,80
6	110	50	1			
8	110	50	1			
6	160	100	1			
8	160	100	1			

Set de demolición y brocas Standmak



Ø (mm)	Largo (mm)	Long. útil (mm)	Unds.	Código	EAN	P.V.P. (€)			
5	110	50	1	D-19180	0088381253826	60,00			
6	110	50	1						
8	110	50	1						
10	110	100	1						
6	160	100	1						
8	160	100	1						
10	160	100	1						
12	160	100	1						
8	210	140	1						
10	210	140	1						
12	260	175	1						
14	260	175	1						
Puntero 14 x 140mm			1						
Puntero 14 x 250mm			1						
Cinzel 20 x 140mm			1						
Cinzel 20 x 250mm			1						
Espátula 40 x 250mm			1						

Brocas de corona para martillos SDS-PLUS



Ø (mm)	Largo (mm)	Unds.	Código	EAN	P.V.P. (€)
40	60	1	P-26191	0088381953092	44,00
50	60	1	P-26200	0088381953108	58,00
65	60	1	P-26216	0088381953115	59,00
80	60	1	P-26222	0088381953122	65,00

Broca de centrado

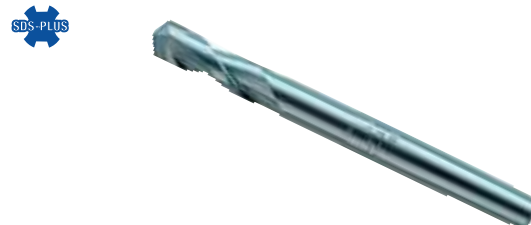

Ø (mm)	Largo (mm)	Punta	Unds.	Código	EAN	P.V.P. (€)
8	120	TCT	1	P-64347	0088381994866	6,70

Adaptador



Rosca (mm)	Largo (mm)	Unds.	Código	EAN	P.V.P. (€)
M16	105	1	P-67745	0088381998277	22,00
M16	370	1	P-67751	0088381998284	34,00



Brocas de corona para mampostería



Ø (mm)	Largo (mm)	Unds.	Código	EAN	P.V.P. (€)
30	50	1	D-73891	0088381586801	7,70
35	50	1	D-73900	0088381586818	8,20
40	50	1	D-73916	0088381586825	8,60
50	50	1	D-73922	0088381586832	10,00
68	50	1	D-73938	0088381586849	12,90
82	50	1	D-73944	0088381586856	17,70
90	50	1	D-73950	0088381586863	21,00
100	50	1	D-73966	0088381586870	24,00

Broca de centrado



Ø (mm)	Largo (mm)	Unds.	Código	EAN	P.V.P. (€)
8	110	1	D-73972	0088381586887	1,75

Set de broca + adaptador



Ø (mm)	Largo (mm)	Unds.	Código	EAN	P.V.P. (€)
68	175	1	D-74011	0088381586924	18,70
82	175	1	D-74027	0088381586931	24,00

Adaptadores



Ø (mm)	Largo (mm)	Unds.	Código	EAN	P.V.P. (€)
110	110	1	D-73988	0088381586894	4,20
200	200	1	D-73994	0088381586900	6,30
350	350	1	D-74005	0088381586917	8,80



Brocas para martillos SDS-MAX



Más precisión, menos vibración, mayor poder de taladrado.

- Tres piezas de carburo con geometría de corte única.

Ángulo de pastilla cambiado.



Pastilla biselada en diferentes puntos.

MAK 4

- Renovada geometría de la broca 4x90° que evita enganches de la pastilla de carburo en hormigones reforzados. Pastillas laterales muy robustas con forma de corte curva que apoyan a la pastilla central en los cortes rápidos.
- Punta de centrado de 130° para facilitar el inicio del taladrado y garantiza una guía perfecta.
- Cada pastilla lateral lleva marcada una línea que indica el desgaste, así podemos evaluar la precisión de los agujeros de anclaje.
- Pastillas de carburo perfectamente soldadas al cuerpo de acero de la broca.
- Punta de carburo de grandes dimensiones con tecnología patentada de biselado lateral* para un óptimo taladrado en hormigón reforzado.

* A partir de ø32mm.

- El diseño de la cabeza de la broca le proporciona una gran dureza, lo que facilita un agresivo efecto de demolición y una alta velocidad de taladrado.
- Diseño de la espiral patentado, con un óptimo rendimiento entre extracción del polvo y resistencia a la rotura.

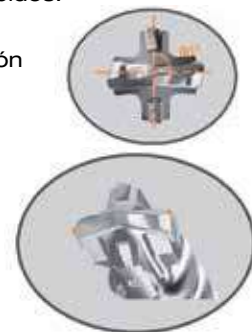

Ø (mm)	Largo (mm)	Long. útil (mm)	Unds.	Código	EAN	P.V.P. (€)
16	340	200	1	P-77730	0088381708487	39,00
16	540	400	1	P-77746	0088381708494	46,00
16	1320	1180	1	P-77768	0088381708517	162,00
18	340	200	1	P-77774	0088381708524	44,00
18	540	400	1	P-77780	0088381708531	48,00
18	1320	1180	1	P-77805	0088381708555	165,00
20	320	200	1	P-77811	0088381708562	44,00
20	520	400	1	P-77827	0088381708579	50,00
20	920	800	1	P-77833	0088381708586	73,00
22	320	200	1	P-77855	0088381708609	49,00
22	520	400	1	P-77861	0088381708616	54,00
22	920	800	1	P-77877	0088381708623	77,00
22	1320	1200	1	P-77883	0088381708630	179,00
24	320	200	1	P-77899	0088381708647	52,00
24	520	400	1	P-77908	0088381708654	60,00
25	320	200	1	P-77914	0088381708661	51,00
25	520	400	1	P-77920	0088381708678	60,00
25	920	800	1	P-77936	0088381708685	90,00
26	520	400	1	P-77958	0088381708708	65,00
28	370	250	1	P-77964	0088381708715	57,00

Ø (mm)	Largo (mm)	Long. útil (mm)	Unds.	Código	EAN	P.V.P. (€)
28	570	450	1	P-77970	0088381708722	68,00
28	670	550	1	P-77986	0088381708739	88,00
28	920	800	1	P-77992	0088381708746	105,00
28	1320	1200	1	P-78003	0088381708753	196,00
30	370	250	1	P-78019	0088381708760	63,00
30	570	450	1	P-78025	0088381708777	74,00
32*	370	250	1	P-78031	0088381708784	65,00
32*	570	450	1	P-78047	0088381708791	79,00
32*	920	800	1	P-78053	0088381708807	120,00
35	370	250	1	P-78075	0088381708821	78,00
35	570	450	1	P-78081	0088381708838	90,00
35	670	550	1	P-78097	0088381708845	109,00
38	370	250	1	P-78134	0088381708883	94,00
38	570	450	1	P-78140	0088381708890	111,00
40	370	250	1	P-78156	0088381708906	111,00
40	570	450	1	P-78162	0088381708913	134,00
40	920	800	1	P-78178	0088381708920	179,00
40	1320	1200	1	P-78184	0088381708937	244,00
45	570	450	1	P-78190	0088381708944	189,00
50	570	450	1	P-78215	0088381708968	215,00

Brocas para martillos SDS-MAX

TCT - 4 cortes



Ø (mm)	Largo (mm)	Long. útil (mm)	Unds.	Código	EAN	P.V.P. (€)
12	340	200	1	E-11324	0088381582605	12,50
12	540	400	1	E-11330	0088381582612	17,20
14	340	200	1	E-11346	0088381582629	15,50
14	540	400	1	E-11352	0088381582636	20,00
16	340	200	1	E-11368	0088381582643	18,40
16	540	400	1	E-11374	0088381582650	23,00
18	340	200	1	E-11380	0088381582667	25,00
18	540	400	1	E-11396	0088381582674	29,00

Ø (mm)	Largo (mm)	Long. útil (mm)	Unds.	Código	EAN	P.V.P. (€)
20	340	220	1	E-11405	0088381582681	29,00
20	540	420	1	E-11411	0088381582698	35,00
22	340	220	1	E-11427	0088381582704	34,00
22	540	420	1	E-11433	0088381582711	40,00
24	340	220	1	E-11449	0088381582728	39,00
24	540	420	1	E-11455	0088381582735	45,00
25	340	220	1	E-11461	0088381582742	40,00
25	540	420	1	E-11477	0088381582759	46,00
28	370	250	1	E-11483	0088381582766	50,00
28	570	450	1	E-11499	0088381582773	61,00
30	370	250	1	E-11508	0088381582780	61,00
30	570	450	1	E-11514	0088381582797	75,00

Brocas SDS-MAX ESTÁNDAR



Ø (mm)	Largo (mm)	Long. útil (mm)	Unds.	Código	EAN	P.V.P. (€)
14	340	200	1	D-33897	0088381364553	14,00
14	540	400	1	D-33906	0088381364560	19,00
16	340	200	1	D-33934	0088381364591	16,00
16	540	400	1	D-33940	0088381364607	20,50
18	340	200	1	D-33956	0088381364614	17,00
18	540	400	1	D-33962	0088381364621	22,00
20	320	200	1	D-33978	0088381364638	19,00
20	520	400	1	D-33984	0088381364645	25,50
22	320	200	1	D-33990	0088381364652	20,50
22	520	400	1	D-34001	0088381364669	28,00
24	320	200	1	D-34017	0088381364676	22,00
24	520	400	1	D-34023	0088381364683	29,50
25	320	200	1	D-34039	0088381364690	22,00

Ø (mm)	Largo (mm)	Long. útil (mm)	Unds.	Código	EAN	P.V.P. (€)
25	520	400	1	D-34045	0088381364706	29,00
28	370	250	1	D-34051	0088381364713	25,50
28	570	450	1	D-34067	0088381364720	39,00
30	370	250	1	D-34073	0088381364737	30,00
30	570	450	1	D-34089	0088381364744	49,00
32	370	250	1	D-34095	0088381364751	42,00
32	570	450	1	D-34104	0088381364768	54,00
35	370	250	1	D-34110	0088381364775	51,50
35	570	450	1	D-34126	0088381364782	57,00
38	370	250	1	D-34132	0088381364799	63,00
38	570	450	1	D-34148	0088381364805	76,00
40	370	250	1	D-34154	0088381364812	70,50
40	570	450	1	D-34160	0088381364829	80,00



Brocas para martillos SDS-MAX



4 ventajas significativas:

1. Mayor vida útil a la broca.
2. Velocidad de perforación superior a la de las brocas convencionales.
3. Rápida eliminación del polvo del taladro = ahorro de tiempo y dinero.
4. Menos vibraciones y energía directamente a la punta de la broca = menos esfuerzo.

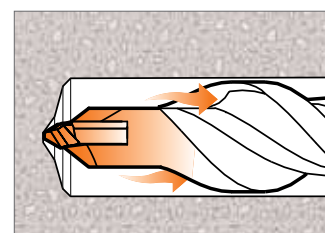

Brocas MAK2



MAK 2

Ø (mm)	Largo (mm)	Long. útil (mm)	Unds.	Código	EAN	P.V.P. (€)
12	340	200	1	P-17033	0088381943369	33,00
12	540	400	1	P-17049	0088381943376	42,00
12	690	550	1	P-17055	0088381943383	59,00
14	340	200	1	P-17077	0088381943406	37,00
14	540	400	1	P-17083	0088381943413	45,00
15	340	200	1	P-17108	0088381943437	37,00
15	540	400	1	P-17114	0088381943444	46,00





Brocas de corona para martillos SDS-MAX



BROCAS DE CORONA IDEALES PARA TALADRAR HORMIGÓN Y MAMPOSTERÍA:

- Alineación del diente asimétrica.
- Espiral externa que reduce el peso un 8%.
- Espesor de la pared del diente reducida y diente biselado en la corona para una mejor penetración en el material.
- Dos ranuras asimétricas para evacuar el polvo.

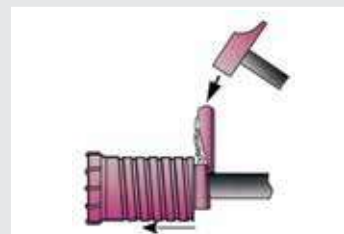

Brocas de corona para martillos SDS-MAX ★★ ★★



Ø (mm)	Largo (mm)	Unds.	Código	EAN	P.V.P. (€)
40	100	1	P-03779	0088381917438	91,00
50	100	1	P-03785	0088381917445	95,00
65	100	1	P-03791	0088381917452	116,00
80	100	1	P-03800	0088381917469	131,00
90	100	1	P-03816	0088381917476	154,00
100	100	1	P-03822	0088381917483	178,00
125	100	1	P-16374	0088381932394	257,00

Broca de centrado para martillos SDS-MAX

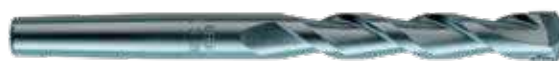

Ø (mm)	Largo (mm)	Unds.	Código	EAN	P.V.P. (€)
11	120	1	P-03838	0088381917490	10,00

Adaptadores



Tipo	Largo (mm)	Unds.	Código	EAN	P.V.P. (€)
Cónico	180	1	P-16994	0088381943321	46,00
Cónico	450	1	P-17005	0088381943338	64,00

Cuña



Unds.	Código	EAN	P.V.P. (€)
1	P-03763	0088381944960	9,40



Brocas de campana para martillos SDS-MAX



Para el empleo en hormigón, mampostería y piedra natural.:

Brocas de campana Makita, es el instrumento moderno para los usuarios profesionales. Una broca de corazón poderoso, desarrollado para la última generación de martillos rotativos, garantiza un taladrado eficiente y una vida superior.

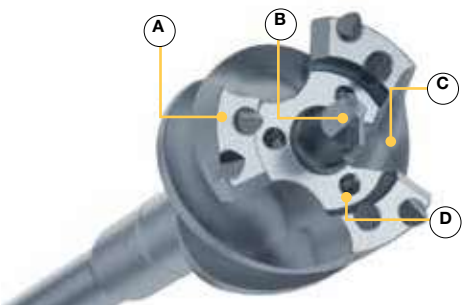

- (A) Dientes de carburo con forma de cincel para una rápida penetración del hormigón.
- (B) Punta central para mayor precisión.
- (C) Tres salidas para retirar grandes cantidades de polvo y desechos.
- (D) Tres dientes de carburo adicionales para demoler las piedras más pequeñas.

- **Menos vibración.**
- **Más ligeras.**
- **Tratamiento especial contra el calor que incrementa la duración de la broca.**
- **Construcción de una sola pieza para una transmisión perfecta de la fuerza.**

Ø (mm)	Largo (mm)	Unds.	Código	EAN	P.V.P. (€)
45	550	1	E-20096	-	220,00
45	990	1	B-57641	0088381519885	233,00
55	550	1	E-20111	-	250,00
55	990	1	E-20127	-	285,00

Ø (mm)	Largo (mm)	Unds.	Código	EAN	P.V.P. (€)
65	550	1	B-57679	0088381519915	246,00
65	990	1	B-57685	0088381519922	292,00
80	550	1	E-20155	-	300,00
80	990	1	B-57700	0088381519953	361,00

Brocas de campana modulares

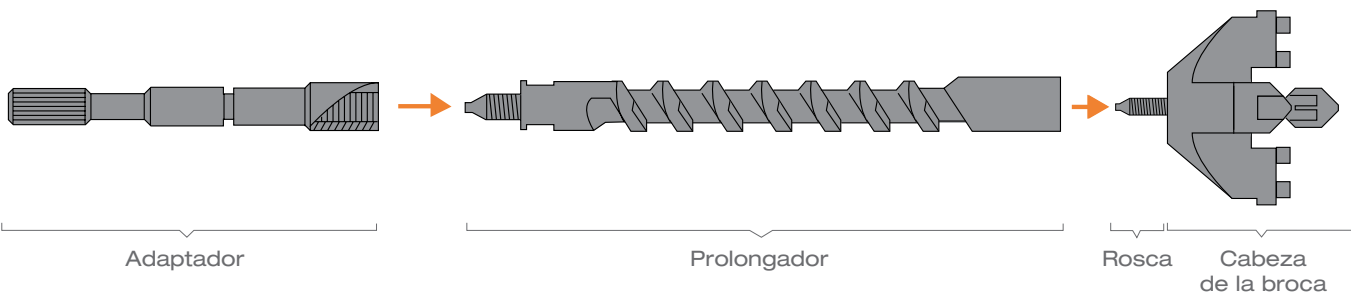

Adaptadores

Tipo	Largo (mm)	Unds.	Código	EAN	P.V.P. (€)
SDS-MAX	195	1	P-03888	0088381917544	60,00
B	175	1	P-03894	0088381917551	50,00

Prolongador

Ø (mm)	Largo (mm)	Unds.	Código	EAN	P.V.P. (€)
25	280	1	P-03925	0088381917582	97,00

Rosca con muelle para cabeza

Ø (mm)	Largo (mm)	Unds.	Código	EAN	P.V.P. (€)
	50	1	P-03931	0088381917599	22,00

Cabeza de broca

Ø (mm)	Largo (mm)	Modelo	Unds.	Código	EAN	P.V.P. (€)
35	150	HR4003C HR4013C	1	P-04008	0088381945028	138,00
40	150		1	P-03844	0088381917506	146,00
50	150		1	P-03850	0088381917513	178,00
55	150		1	P-04014	0088381945035	196,00
60	150	HR4003C HR4013C HR4501C HR4511C HR5202C HR5212C	1	P-04020	0088381945042	200,00
68	150		1	P-03866	0088381917520	220,00
80	150		1	P-03872	0088381917537	280,00
90	150		1	P-04036	0088381945059	396,00



P-03931



MAK - Conexión SDS-MAX

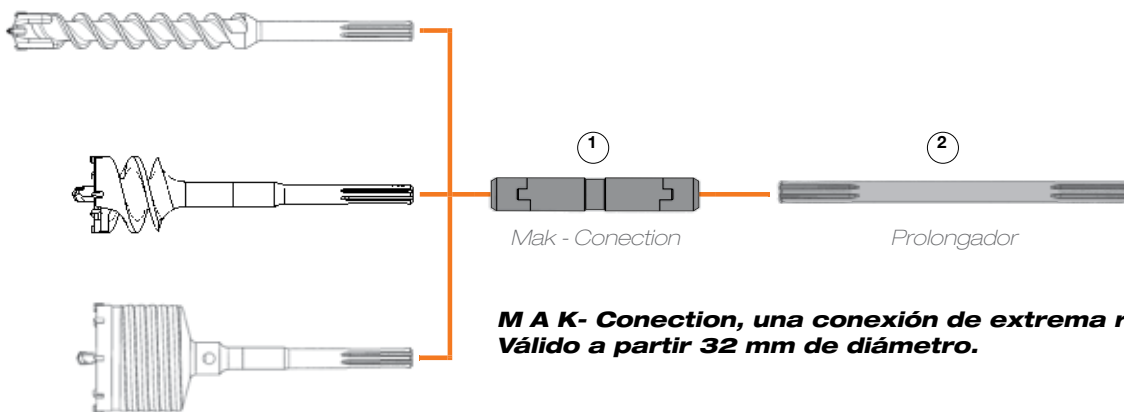

MAK-Connection, una conexión de extrema robustez. Válido a partir 32 mm de diámetro.

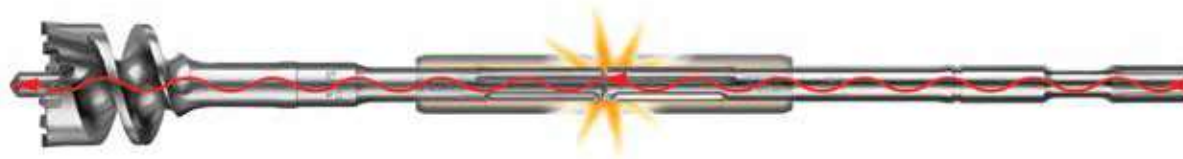

Sistema de conexión para brocas, MAK-Connection. Una revolución en el universo del taladrado.

Ventajas del sistema MAK-Connection:

- El sistema SDS-MAX, MAK-Connection, permite una conexión segura y rápida entre la broca y el adaptador.
- Sin pérdidas de energía, contrariamente a los sistemas existentes. La totalidad de la potencia es transmitida a la broca.

Cambios de inserción



Descripción	Longitud (mm)	Accesorio	Unds.	Código	EAN	P.V.P. (€)
Mak Conection	-	SDS-MAX	1	P-53914	0088381984423	204,00
Prolongador	320		1	P-53920	0088381984430	29,00
Prolongador	750		1	P-53936	0088381984447	36,00
Prolongador	1100		1	P-53942	0088381984454	50,00

Descripción	Máquina	Accesorio	Unds.	Código	EAN	P.V.P. (€)
Adaptador	K	SDS-MAX	1	P-02319	0088381944953	157,00
Adaptador	SDS-MAX	SDS-PLUS	1	P-17027	0088381943352	79,00



Makita

XGT X2
80V_{max}



**Sistemas
de aspiración
para martillos.**



XGT
40V_{max} Li-ion



SDS-PLUS

Punteros



- Para todo tipo de obras en mampostería, hormigón y piedra suelta.



B-64238

Ancho (mm)	Largo (mm)	Serie	Unds.	Código	EAN	P.V.P. (€)
14	250	Premium ★★★★★	1	B-64238	0088381534444	12,20
14	250	Long life ★★★	1	B-64294	0088381534505	8,30
14	250	Standard ★★	1	D-08713	0088381179522	4,10
14	250	Long life ★★★	1	P-05505	0088381921299	9,90

Cinceles



- Para todo tipo de obras en mampostería, hormigón y piedra suelta.



B-64244

Ancho (mm)	Largo (mm)	Serie	Unds.	Código	EAN	P.V.P. (€)
20	250	Premium ★★★★★	1	B-64244	0088381534451	12,20
20	250	Long life ★★★	1	B-64303	0088381534512	8,30
20	250	Standard ★★	1	D-08729	0088381179539	3,90
22	250	Long life ★★★	1	P-05511	0088381921305	9,90

Espátulas



- Para la demolición universal en materiales de mayor volumen.



B-64250

Ancho (mm)	Largo (mm)	Serie	Unds.	Código	EAN	P.V.P. (€)
40	250	Premium ★★★★★	1	B-64250	0088381534468	17,80
40	250	Long life ★★★	1	B-64319	0088381534529	12,30
40	250	Standard ★★	1	D-08735	0088381179546	5,20
40	250	Long life ★★★	1	P-05527	0088381921312	14,90
50	215	Standard ★★	1	D-25616	0088381338431	5,60

Espátula para asfalto



- Para la obra en carretera, por ejemplo, en el saneamiento de superficies u otras reparaciones de calzada.



P-24935

Ancho (mm)	Largo (mm)	Serie	Unds.	Código	EAN	P.V.P. (€)
60	250	Long life ★★★	1	P-24935	0088381951845	18,20



Espátula dentada



- Para sanear muros, eliminar masilla de juntas.



P-25096

Ancho (mm)	Largo (mm)	Serie	Unds.	Código	EAN	P.V.P. (€)
32	200	Long life ★★★	1	P-25096	0088381952002	70,00

Espátulas curvas



- Retirada de azulejos de forma fácil y sencilla (con extremo acodado de forma ergonómica).



P-24941

Ancho (mm)	Largo (mm)	Serie	Unds.	Código	EAN	P.V.P. (€)
40	200	Long life	1	P-24941	0088381951852	13,80
60	250	★★★	1	P-24957	0088381951869	19,30

Escoplos



- Para acanalar en mampostería.



P-05533

Ancho (mm)	Largo (mm)	Serie	Unds.	Código	EAN	P.V.P. (€)
22	250	Long life	1	P-05533	0088381921329	16,00
22	240	★★★	1	P-25080	0088381951999	14,90

Escoplo acanalado con aletas



- Para tratamiento de piedra caliza, hormigón, ladrillos, piedra pómez, especialmente efectivo y seguro debido a su profundidad de acanalado variable de 10-35 mm. sin resbalar hacia el interior del surco.



P-24963

Ancho (mm)	Largo (mm)	Serie	Unds.	Código	EAN	P.V.P. (€)
22	250	Long life ★★★	1	P-24963	0088381951876	28,00

SDS-PLUS

Formones



- Para trabajos de carpintería en general, rápido arranque de material de madera blanda, por ejemplo para arrancar marcos de ventanas viejos.

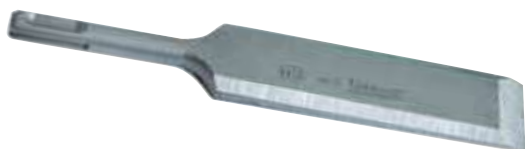

P-25111

Ancho (mm)	Largo (mm)	Serie	Unds.	Código	EAN	P.V.P. (€)
20	170	Long life	1	P-25105	0088381952019	20,00
30	170	★★★	1	P-25111	0088381952026	27,00

Set de demolición



Contenido	Unds.	Código	EAN	P.V.P. (€)
Puntero 14 x 250mm	1	D-05181	0088381177450	26,00
Cinzel 20 x 250mm	1			
Espátula 40 x 250mm	1			

Raspador



- Para levantar moquetas y retirar pegamentos de superficies rígidas.



A-68161

Ancho (mm)	Descrip.	Tipo	Unds.	Código	EAN	P.V.P. (€)
100	Raspador	-	1	A-68161	0088381537254	86,00
-	Cuchilla	Para A-68161	1	343411-9	0088381118415	31,00

Set de demolición



Contenido	Unds.	Código	EAN	P.V.P. (€)
Puntero 14 x 250mm	2	D-16368	0088381187848	37,00
Cinzel 20 x 250mm	2			
Espátula 40 x 250mm	1			

Set de demolición



Contenido	Unds.	Código	EAN	P.V.P. (€)
Puntero 250mm	1	D-42357	0088381404815	32,00
Cinzel 20 x 250mm	1			
Espátula 40 x 250mm	1			



SDS-MAX

Punteros



- Para todo tipo de obras en mampostería, hormigón y piedra suelta.



B-10366

Ancho (mm)	Largo (mm)	Serie	Unds.	Código	EAN	P.V.P. (€)
18	280	Long life ★★★	1	P-16237	0088381932264	8,60
18	400		1	P-16243	0088381932271	12,70
18	600		1	P-16259	0088381932288	16,80
18	300	Standard ★★	1	D-34176	0088381364836	6,20
18	400		1	D-34182	0088381364843	7,80
18	400		10	D-34182-10	0088381367240	71,00
18	600		1	D-34198	0088381364850	10,00
18	400	Autoafilable espiral ★★★★★	1	B-23064	0088381406161	21,00

Cinceles



- Para todo tipo de obras de mampostería, hormigón y piedra suelta.



P-16265

Ancho (mm)	Largo (mm)	Serie	Unds.	Código	EAN	P.V.P. (€)
25	280	Long life ★★★	1	P-16265	0088381932295	8,60
25	400		1	P-16271	0088381932301	12,70
25	600		1	P-16287	0088381932318	16,80
25	300	Standard ★★	1	D-34207	0088381364867	6,20
25	400		1	D-34213	0088381364874	8,10
25	400		10	D-34213-10	0088381367257	76,00
25	600		1	D-34229	0088381364881	9,60

Set de 5 punteros y 5 cinceles



Ancho (mm)	Largo (mm)	Serie	Unds.	Código	EAN	P.V.P. (€)
18	400	Standard ★★	5	D-35324-10	0088381367905	57,00
25	400		5			



Espátulas



- Para la demolición en material de mayor volumen.



P-16302

Ancho (mm)	Largo (mm)	Serie	Unds.	Código	EAN	P.V.P. (€)
50	350	Long life ★★★	1	P-16302	0088381932332	17,10
80	300		1	P-16318	0088381932349	26,00
50	400	Standard ★★	1	D-34235	0088381364898	8,80
80	300		1	D-34241	0088381364904	14,30

Espátula curva



- Retirada de azulejos de forma fácil y sencilla. Con extremo acodado de forma ergonómica.



P-16324

Ancho (mm)	Largo (mm)	Serie	Unds.	Código	EAN	P.V.P. (€)
50	300	Long life ★★★	1	P-16324	0088381932356	26,00

Espátula dentada



- Para sanear muros, por ejemplo, para eliminar ma-silla de juntas.



P-16346

Ancho (mm)	Largo (mm)	Serie	Unds.	Código	EAN	P.V.P. (€)
38	280	Long life ★★★	1	P-16346	0088381932370	66,00

Escoplo



- Para acanalar en mampostería.



P-16293

Ancho (mm)	Largo (mm)	Serie	Unds.	Código	EAN	P.V.P. (€)
26	300	Long life ★★★	1	P-16293	0088381932325	27,00

SDS-MAX

Escoplo acanalado con aletas



- Para acanalar en piedra caliza, hormigón, ladrillos, piedra pómez, especialmente efectivo y seguro debido a su profundidad de acanalado variable de 10-35 mm. sin resbalar hacia el interior del surco.



Ancho (mm)	Largo (mm)	Serie	Unds.	Código	EAN	P.V.P. (€)
35	380	Long life ★★★	1	P-16330	0088381932363	52,00

Pala



- Perfecta para sacar tierra.



Ancho (mm)	Largo (mm)	Serie	Unds.	Código	EAN	P.V.P. (€)
110	400	Long life ★★★	1	P-23721	0088381950664	52,00

Pisón



- Para compactar materiales blandos.



Adaptador



Pisón

Ø (mm)	Descripción	Serie	Unds.	Código	EAN	P.V.P. (€)
140	Pisón	Long life ★★★	1	A-19875	0088381158985	89,00
-	Adaptador pisón	★★★	1	A-19897	0088381159005	43,00

Bujarda



- Para abujardar zonas de piedra u hormigón.



Adaptador



Base

Medida (mm)	Descripción	Serie	Unds.	Código	EAN	P.V.P. (€)
60x60	Base	Long life ★★★	1	P-03947	0088381932820	82,00
250	Adaptador	★★★	1	P-16352	0088381932387	30,00

Adaptador para picas de toma de tierra

- Para clavar las picas en tierra.



502024

Ø (mm)	Largo (mm)	Serie	Unds.	Código	EAN	P.V.P. (€)
13	260	Long life ★★★	1	502024	-	39,00
16	260		1	P-63797	0088381994316	44,00
19	260		1	502026	-	49,00
22,2	260		1	E-13041	0088381590211	61,00

Estuches SDS-MAX



Contenido	Serie	Unds.	Código	EAN	P.V.P. (€)
Punteros	Standard ★★	2	D-40565	0088381403405	66,00
Cinceles		2			
Espátulas		2			



Contenido	Serie	Unds.	Código	EAN	P.V.P. (€)
Puntero	Standard ★★	1	D-42450	0088381404914	49,00
Cinzel		1			
Espátula		1			



Makita Hexagonal 17mm

- Para modelos **HM0810T** y **HM0830T**

Punteros



- Para todo tipo de obras en mampostería, hormigón y piedra suelta.



D-08682

Ancho (mm)	Largo (mm)	Serie	Unds.	Código	EAN	P.V.P. (€)
17	280	Standard ★★	1	D-08682	0088381182911	3,60
17	450		1	D-16863	0088381192897	10,00
17	450	Long life ★★★	1	P-13041	0088381932844	22,00

Espátulas



- Para la demolición en material de mayor volumen.



P-13079

Ancho (mm)	Largo (mm)	Serie	Unds.	Código	EAN	P.V.P. (€)
50	280	Standard ★★	1	D-20694	0088381277709	5,60
45	280	Long life ★★★	1	P-13079	0088381932875	22,00

Escoplo acanalado con aletas



- Para acanalar en piedra caliza, hormigón, ladrillos, piedra pómez, especialmente efectivo y seguro debido a su profundidad de acanalado variable de 10-35 mm. sin resbalar hacia el interior del surco.



P-13100

Ancho (mm)	Largo (mm)	Serie	Unds.	Código	EAN	P.V.P. (€)
35	380	Long life ★★★	1	P-13100	0088381932905	40,00



Cinceles



- Para todo tipo de obras de mampostería, hormigón y piedra suelta.



D-08707

Ancho (mm)	Largo (mm)	Serie	Unds.	Código	EAN	P.V.P. (€)
19	280	Standard ★★	1	D-08707	0088381182935	5,90
19	450		1	D-16879	0088381192880	6,50
24	280	Long life ★★★	1	P-13057	0088381932851	16,00
24	450		1	P-13063	0088381932868	18,60

Escoplo curvo



- Para acanalar en mampostería.



P-67393

Ancho (mm)	Largo (mm)	Serie	Unds.	Código	EAN	P.V.P. (€)
26	280	Long life ★★★	1	P-67393	0088381997928	33,00



B Hexagonal 19mm

- Para modelos **HR3520B, HR3850B, HR5000 y *HM1200B.**

Punteros



- Para todo tipo de obras en mampostería, hormigón y piedra suelta.



D-20074

Ancho (mm)	Largo (mm)	Serie	Unds.	Código	EAN	P.V.P. (€)
19	300	Standard	1	D-20074	0088381256087	9,00
19	450	★★	1	D-19196	0088381253918	10,20
19	300	Long life	1	P-13122	0088381932912	16,40
19	450	★★★	1	P-13138	0088381932929	21,00

- Para modelo **HM1200B**



Ø (mm)	Largo (mm)	Serie	Unds.	Código	EAN	P.V.P. (€)
19	400	Long life	1	P-05620	0088381921411	16,50
19	600	★★★	1	P-05614	0088381921404	22,00

Cinceles



- Para todo tipo de obras de mampostería, hormigón y piedra suelta.



P-13144

Ancho (mm)	Largo (mm)	Serie	Unds.	Código	EAN	P.V.P. (€)
24	300	Long life	1	P-13144	0088381932936	16,70
24	450	★★★	1	P-13150	0088381932943	20,00

- Para modelo **HM1200B.**



Ancho (mm)	Largo (mm)	Serie	Unds.	Código	EAN	P.V.P. (€)
25	400	Long life	1	P-05636	0088381921428	15,60
25	600	★★★	1	P-05642	0088381921435	21,00

Pala



- Para modelo **HM1200B.**



P-05670

Ancho (mm)	Largo (mm)	Serie	Unds.	Código	EAN	P.V.P. (€)
105	400	Long life	1	P-05670	0088381921466	67,00

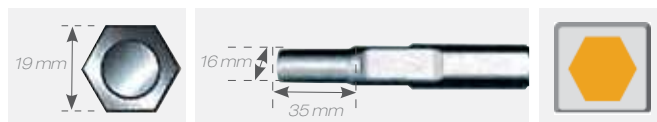

Escoplo curvo



- Para acanalar en mampostería.



P-13188

Ancho (mm)	Largo (mm)	Serie	Unds.	Código	EAN	P.V.P. (€)
22	250	Long life	1	P-13188	0088381932974	25,00

- Para modelo **HM1200B**



Ancho (mm)	Largo (mm)	Serie	Unds.	Código	EAN	P.V.P. (€)
22	300	Long life	1	P-05658	0088381921442	25,00

Escoplo acanalado con aletas



- Para acanalar en piedra caliza, hormigón, ladrillos, piedra pómez, especialmente efectivo y seguro debido a su profundidad de acanalado variable de 10-35 mm. Sin resbalar hacia el interior del surco.

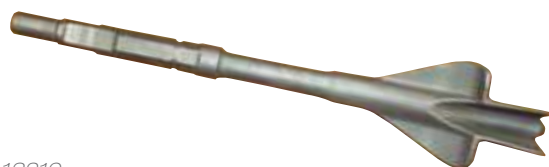

P-13219

Ancho (mm)	Largo (mm)	Serie	Unds.	Código	EAN	P.V.P. (€)
35	380	Long life	1	P-13219	0088381932998	58,00

Espátulas



- Para la demolición en material de mayor volumen.



P-13166

Ancho (mm)	Largo (mm)	Serie	Unds.	Código	EAN	P.V.P. (€)
50	300	Long life	1	P-13166	0088381932950	29,00

- Para modelo **HM1200B.**



Ancho (mm)	Largo (mm)	Serie	Unds.	Código	EAN	P.V.P. (€)
60	300	Long life	1	P-05664	0088381921459	31,00
60	450	★★★	1	P-05686	0088381921473	40,00



Makita Hexagonal 21mm

- Para modelo **HM1200**.

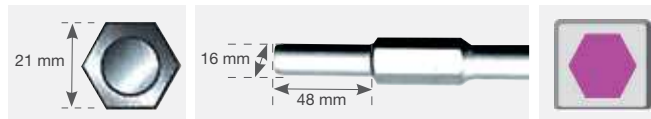

Punteros

- Para todo tipo de obras en mampostería, hormigón y piedra suelta.



P-13378

Ancho (mm)	Largo (mm)	Serie	Unds.	Código	EAN	P.V.P. (€)
21	450	Standard ★★	1	D-23824	0088381312912	9,60
21	320	Long life ★★★	1	P-13378	0088381112468	19,00
21	450		1	P-13384	0088381943116	25,00
21	600		1	P-13390	0088381104432	26,00

Cinceles

- Para todo tipo de obras de mampostería, hormigón y piedra suelta.



P-13409

Ancho (mm)	Largo (mm)	Serie	Unds.	Código	EAN	P.V.P. (€)
24	320	Long life ★★★	1	P-13409	0088381943147	20,00
24	450		1	P-13415	0088381943154	26,00

Pala



798035-0

Ancho (mm)	Largo (mm)	Serie	Unds.	Código	EAN	P.V.P. (€)
120	450	Long life ★★★	1	798035-0	0088381103558	98,00



Makita Hexagonal 30mm

- Para modelos **HM1317C, HM1307C y *HM1400.**

Punteros

- Para todo tipo de obras en mampostería, hormigón y piedra suelta.



D-15285

Ancho (mm)	Largo (mm)	Serie	Unds.	Código	EAN	P.V.P. (€)
30	410	Standard ★★	1	D-15285	0088381186377	17,70
30	400	Long life ★★★	1	P-05549	0088381921336	33,00
30	400		1	B-10388*	0088381342483	37,00
30	700		1	P-05561	0088381921350	48,00

*autoafilable

Espátulas

- Para la demolición en material de mayor volumen.



D-23868

Ancho (mm)	Largo (mm)	Serie	Unds.	Código	EAN	P.V.P. (€)
75	310	Standard ★★	1	D-23868	0088381313094	23,00
75	310		1	D-34805*	0088381365802	23,00
115	400	Long life ★★★	1	P-13518	0088381943239	78,00

*especial para suelo

- Para modelo **HM1400.**

Ancho (mm)	Largo (mm)	Serie	Unds.	Código	EAN	P.V.P. (€)
110	400	Long life ★★★	1	P-13493	0088381943215	65,00



Cinceles

- Para todo tipo de obras de mampostería, hormigón y piedra suelta.



D-15300

Ancho (mm)	Largo (mm)	Serie	Unds.	Código	EAN	P.V.P. (€)
30	400	Standard ★★	1	D-15300	0088381186384	18,40
32	410	Long life ★★★	1	P-13487	0088381943208	32,00

- Para modelo **HM1400**

Ancho (mm)	Largo (mm)	Serie	Unds.	Código	EAN	P.V.P. (€)
32	400	Long life ★★★	1	P-13502	0088381943222	33,00
32	700		1	P-05583	0088381921374	47,00

Pisón



A-31485

Ø (mm)	Serie	Unds.	Código	EAN	P.V.P. (€)
200	Long life ★★★	1	A-31485	0088381151610	123,00

Pala

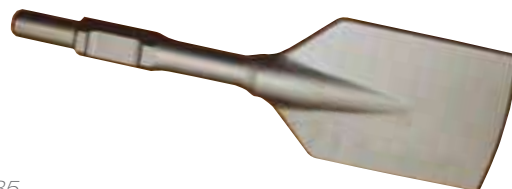

A-31485

Ancho (mm)	Largo (mm)	Tipo	Unds.	Código	EAN	P.V.P. (€)
125	400	Long life ★★★	1	P-05555	0088381921343	81,00
120	500	Standar ★★	1	B-10300	0088381341288	106,00

- Para modelo **HM1400**

Ancho (mm)	Largo (mm)	Serie	Unds.	Código	EAN	P.V.P. (€)
125	400	Long life ★★★	1	P-05608	0088381921398	62,00



Makita Hexagonal 28,6mm

- Para modelos **HM1317CB**, **HM1304B**, **HM1801**, **HM1810** y **HM1812**.



Punteros

- Para todo tipo de obras en mampostería, hormigón y piedra suelta.



P-05692

Ancho (mm)	Largo (mm)	Serie	Unds.	Código	EAN	P.V.P. (€)
28,6	400	Long life	1	P-05692	0088381921480	30,00
28,6	600	★★★	1	P-64272	0088381994798	50,00
28,6	400	Premium ★★★★	1	B-10372*	0088381342476	34,00

*autoafilable



D-17631

Ancho (mm)	Largo (mm)	Serie	Unds.	Código	EAN	P.V.P. (€)
28,6	400	Long life	1	D-17631	0088381197182	20,00
28,6	600	★★★	1	P-65931	0088381996464	39,00

Espátulas

- Para la demolición en material de mayor volumen.



D-29228

Ancho (mm)	Largo (mm)	Serie	Unds.	Código	EAN	P.V.P. (€)
75	410	Standard ★★	1	D-29228	0088381345682	21,00
80	400	Long life ★★★	1	P-05701	0088381921497	52,00

Pala



P-05717

Ancho (mm)	Largo (mm)	Serie	Unds.	Código	EAN	P.V.P. (€)
125	400	Long life ★★★	1	P-05717	0088381921503	75,00

Cinceles

- Para todo tipo de obras de mampostería, hormigón y piedra suelta.

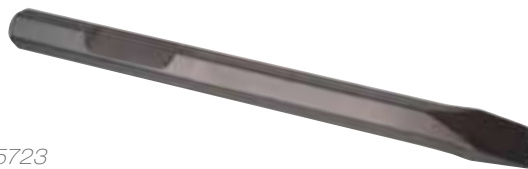

P-05723

Ancho (mm)	Largo (mm)	Serie	Unds.	Código	EAN	P.V.P. (€)
35	400	Long life	1	P-05723	0088381921510	29,00
30	600	★★★	1	P-64288	0088381994804	50,00



P-65947

Ancho (mm)	Largo (mm)	Serie	Unds.	Código	EAN	P.V.P. (€)
28	410	Standard ★★	1	D-17647	0088381197199	20,00
30	600	Long life ★★★	1	P-65947	0088381996471	39,00

Pisón



798385-3

Ø (mm)	Serie	Unds.	Código	EAN	P.V.P. (€)
200	Long life ★★★	1	798385-3	0088381127554	217,00

- **Uso de puntero con anilla**

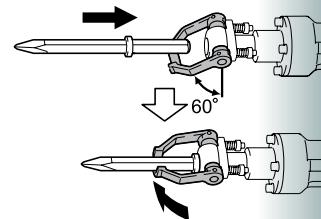

- **Uso de puntero con rebaje**

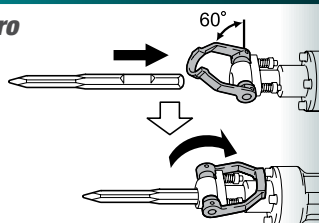

K Hexagonal 21mm

- Para modelos K.



Punteros



- Para todo tipo de obras en mampostería, hormigón y piedra suelta.

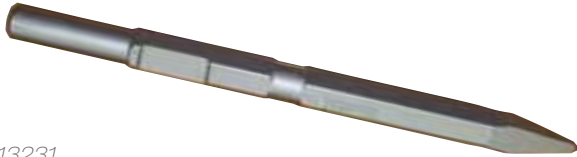

P-13231

Ancho (mm)	Largo (mm)	Serie	Unds.	Código	EAN	P.V.P. (€)
21	300	Long life	1	P-13231	0088381933001	19,30
21	460	★★★	1	P-13253	0088381943024	25,00

Cinceles



- Para todo tipo de obras de mampostería, hormigón y piedra suelta.



P-13275

Ancho (mm)	Largo (mm)	Serie	Unds.	Código	EAN	P.V.P. (€)
25	300	Long life ★★★	1	P-13275	0088381126717	19,30
25	460		1	P-13297	0088381943062	22,00
25	600		1	P-13306	0088381943079	29,00

Espátulas



- Para la demolición en material de mayor volumen.



P-13312

Ancho (mm)	Largo (mm)	Serie	Unds.	Código	EAN	P.V.P. (€)
75	300	Long life ★★★	1	P-13312	0088381943086	33,00

Escoplo acanalado con aletas



- Para acanalar en piedra caliza, hormigón, ladrillos, piedra pómez, especialmente efectivo y seguro debido a su profundidad de acanalado variable de 10-35 mm. sin resbalar hacia el interior del surco.

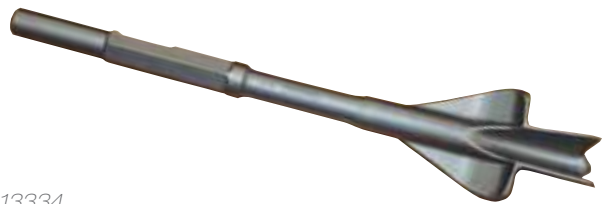

P-13334

Ancho (mm)	Largo (mm)	Serie	Unds.	Código	EAN	P.V.P. (€)
35	380	Long life ★★★	1	P-13334	0088381943109	58,00

HM1812

**Sistema antivibración AVT
Carcasa antivibración,
4 muelles y modo ralenti,**



Makita Hexagonal 19mm

- Para modelo **HK1810**



Puntero



- Para todo tipo de obras en mampostería, hormigón y piedra suelta.



Ancho (mm)	Largo (mm)	Serie	Unds.	Código	EAN	P.V.P. (€)
19	220	Long life ★★★	1	B-06921	0088381313292	14,30

Cinceles curvos



- Retirada de azulejos de forma fácil y sencilla (con extremo acodado de forma ergonómica).



Ancho (mm)	Largo (mm)	Serie	Unds.	Código	EAN	P.V.P. (€)
35	190	Long life ★★★	1	P-05496	0088381921282	26,00
50	190		1	P-05474	0088381921268	27,00

Rascador



Ancho (mm)	Tipo	Unds.	Código	EAN	P.V.P. (€)
100	Rascador completo	1	A-68155	0088381114882	71,00
100	Solo Cuchilla	1	343411-9	0088381118415	31,00

Cinzel



- Para todo tipo de obras de mampostería, hormigón y piedra suelta.

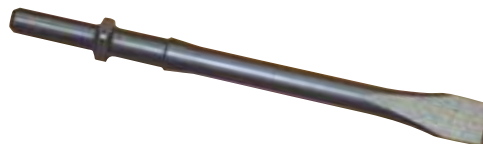

Ancho (mm)	Largo (mm)	Serie	Unds.	Código	EAN	P.V.P. (€)
20	220	Long life ★★★	1	B-07004	0088381313308	17,90

Espátula



- Para la demolición en material de mayor volumen.



Ancho (mm)	Largo (mm)	Serie	Unds.	Código	EAN	P.V.P. (€)
50	220	Long life ★★★	1	B-07010	0088381313315	20,00

Escoplo

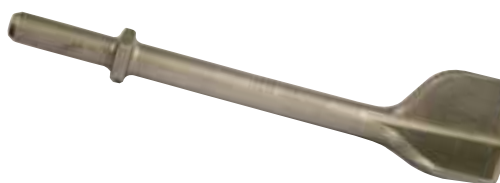

Ancho (mm)	Serie	Unds.	Código	EAN	P.V.P. (€)
45	Long life ★★★	1	P-05480	0088381921275	30,00



Set eje - mandril para martillos SDS-MAX



Descripción	Rosca	Inserción	Unds.	Código	EAN	P.V.P. (€)
Set	1/2"	SDS-MAX	1	122829-5	0088381435901	65,00

Portabrocas y portaherramientas para martillos ligeros



Portabrocas automático



Portaherramientas SDS-PLUS

Descripción	mm	Modelos	Unds.	Código	EAN	P.V.P. (€)
Portabrocas	13	DHR243 DHR263 HR002G HR2630T HR2631FT HR2810T HR2811FT	1	194079-2	0088381196826	64,00
	13	DHR281 DHR283	1	199139-5	0088381525695	55,00
	13	HR3210FCT	1	194568-7	0088381347389	74,00
	13	HR008G HR3012	1	191F46-4	0088381560795	55,00
Portaherramientas SDS-PLUS	-	DHR243 DHR263 HR2630T HR2631FT HR2810T HR2811FT	1	194080-7	0088381196833	33,00
	-	DHR281 DHR283	1	199138-7	0088381525718	24,00
	-	HR3210FCT	1	125420-8	3240890170774	59,00
	-	HR3012	1	191F47-2	0088381560801	34,00



Gancho para HR008



Descripción	Unds.	Código	EAN	P.V.P. (€)
Práctico gancho para HR008	1	191W90-3	-	10,50

Set eje - mandril para martillos SDS-PLUS



P-18150



D-14093

con portabrocas

Descripción	Rosca	Inserción	Unds.	Código	EAN	P.V.P. (€)
Set	1/2"	SDS-PLUS	1	P-18150	0088381944472	47,00
Adaptador	1/2"	SDS-PLUS	1	D-14093	0088381359450	2,80

Perilla de soplado



Unds.	Código	EAN	P.V.P. (€)
1	765009-6	0088381102377	2,45

Aceite grafitado



Contenido (gr)	Unds.	Código	EAN	P.V.P. (€)
30	1	P-08361	0088381913072	3,30

Paño para limpieza



Unds.	Código	EAN	P.V.P. (€)
1	443122-7	0088381205658	3,30

Grasa para broca



198993-4

183477-5

Contenido (gr)	Unds.	Código	EAN	P.V.P. (€)
30	1	183477-5	0088381373760	4,10
100	1	198993-4	0088381518994	6,60



Sistemas de protección frente al polvo

Cada día Makita cuida la salud y la comodidad en el trabajo de nuestros usuarios, y uno de los mayores peligros es la inhalación de polvo mineral.



A la larga puede causar graves problemas respiratorios por lo que resulta imprescindible actuar sobre este problema.

Para eso, Makita ha desarrollado una completa gama de accesorios de aspiración para la conexión con gran parte de nuestros martillos ligeros.

El polvo no es algo que puedas esconder debajo de la alfombra, es algo peligroso que puede afectar a tu salud. **¡Actúa!**



Colectores de polvo auto aspirantes



Tipo	Modelos	Medidas (mm)	Unds.	Código	EAN	P.V.P. (€)
DX06	DHR242	372 x 88 x 287	1	199563-2	0088381540346	126,00
DX02	DHR243	397 x 88 x 287	1	195902-4	0088381400626	122,00
DX05	DHR182	431 x 82 x 285	1	199664-6	0088381540315	97,00
DX08	"DHR280 DHR282"	435 x 86 x 306	1	199581-0	0088381540827	155,00
DX09	"DHR281 DHR283"	457 x 86 x 306	1	199585-2	0088381540865	155,00
DX10	HR3011FC	592 x 145 x 242	1	191F95-1	0088381565752	121,00
DX11	HR3012FC	661 x 145 x 242	1	191G00-4	0088381565806	121,00
DX12	HR001G HR003G	425 x 86 x 306	1	191E54-9	0088381560047	171,00



Filtro para DX01, DX02, DX03, DX05, DX08, DX09 y DX12



Válido	Descripción	Unds.	Código	EAN	P.V.P. (€)
DX01 DX02 DX08 DX09 DX12	Filtro HEPA	1	199557-7	0088381539784	11,80
DX03	Set alojamiento de filtro	1	196162-1	0088381413220	32,00
DX05	Filtro HEPA	1	199596-7	0088381541466	9,40
DX10 DX11	Set caja colector de polvo	1	191F49-8	0088381560818	52,00



Colector de polvo para martillo ligero



Modelo	Unds.	Código	EAN	P.V.P. (€)
HR007G	1	191X40-4	-	121,00



Extractor de polvo



Modelos	Unds.	Código	EAN	P.V.P. (€)
HR2230 HR2460 HR2470	1	193472-7	0088381174022	49,00

Recolector de polvo para martillos SDS-PLUS



Modelos	Unds.	Código	EAN	P.V.P. (€)
DHR171 DHR182 DHR202 DHR263 HR140D HR166D HR1830 HR1841F HR2230 HR2470 HR2800 HR2810 HR2811	1	198362-9*	0088381483636	11,80

* Utilizar con adaptador.

Adaptadores para utilizar con recolector de polvo. 198362-9

Modelos	Unds.	Código	EAN	P.V.P. (€)
DHR165 DHR171 DHR182 HR1830 HR140D HR166D HR1841F	1	194581-5	0088381371599	14,30
DHR202 DHR263 HR2810T HR2811FT	1	194582-3	0088381367219	5,50
HR2230 HR2460 HR2470	1	194583-1	0088381367226	5,10
HR3011 HR3012	1	191L91-5	0088381567411	6,00

Bolsa de polvo



Modelos	Unds.	Código	EAN	P.V.P. (€)
HR2430	1	193976-9	0088381191333	14,30
HR2432	1	122708-7	0088381202992	9,00

Tapas para polvo



Tipo 1

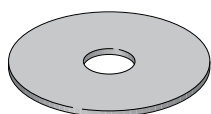

Indicado para	Tipo	Unds.	Código	EAN	P.V.P. (€)
Brocas 6 a 14 mm. Ø	1	1	421342-3	008838116602	2,45
Brocas 12 a 16 mm. Ø	1	1	421664-1	0088381149754	3,90
HK1810	2	1	423154-0	0088381123846	0,80

Colector de polvo para martillos SDS-PLUS



Podemos conectar dos colectores para aspirar cuando trabajemos con brocas más largas.

Modelos	Unds.	Código	EAN	P.V.P. (€)
DHR242 DHR280 DHR282 HR2630 HR2600 HR2300	1	195173-3	0088381361125	7,50
DHR243 DHR281 DHR283 HR2611FT HR2630T	1	195179-1	0088381361194	9,00

Adaptador 1/2" a SDS-MAX (para sacar brocas que se han quedado bloqueadas)



* Utilizar con llaves de impacto de 1/2".

Tipo	Unds.	Código	EAN	P.V.P. (€)
1/2"	1	195870-1	0088381398336	110,00



Colectores de polvo para martillos combinados



Makita

Kit

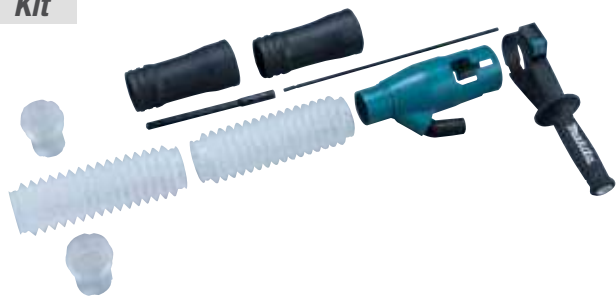

Modelos	Unds.	Código	EAN	P.V.P. (€)
HR4001C HR4011C HR4501C HR4511C	1	196074-8	0088381407632	112,00
HR5212C	1	196858-4	0088381441599	82,00
DHR400 HR4003C HR4013C	1	199142-6	0088381524339	107,00



Colectores de polvo para martillos demoledores



Modelos	Unds.	Código	EAN	P.V.P. (€)
HM002G	1	199143-4	0088381524346	20,00
HM1307C HM1317C HM1400 HM1812	1	197168-2	0088381449984	57,00
HM1501	1	191M20-4	0088381575713	67,00



Empuñaduras

Tipo 1

* Solo empuñadura



Tipo 2

* Empuñadura completa



Modelos	Unds.	Código	EAN	P.V.P. (€)
HR2800 HR2230 HR2460 HR2470 HR2810 HR2811	1	158057-6	3240890278531	4,90
HR2510	1	273496-0	3240890119971	12,10
HR3000C HM0860C HM0830T	1	152554-4	0088381156318	9,10
HR3520B HR3850B HR5000K	1	273472-4	0088381115841	11,00
HR4000C HR4001C HR4011C	1	134803-1	0088381144384	30,00
HR4501C HR4511C HR5201C HR5211C	1	158131-0	0088381346115	11,00
HM0810T HR3850B HR3520B	1	273457-0	0088381123440	11,60

Modelos	Unds.	Código	EAN	P.V.P. (€)
HR3520B HR3850B HR5000 HR5000K	1	134887-9	0088381151474	40,00
HR4000C HR4001C HR4011C HR4501C HR4511C HM1111C HM1101C HR3540C HR3541FC	1	134890-0	0088381152266	36,00
HR4500C	1	134915-0	0088381160087	30,00
HR5001C	1	134945-1	0088381164979	30,00
HR5201C HR5211C HM1202C HM1203C HM1213C	1	135269-8	0088381359528	42,00
HM1200K	1	134944-3	0088381200998	24,00
HM0860C HM0830T HM0870C HM0871C HM1100C HM1200 HM1200B	1	134909-5	0088381164962	28,00
HM1214C HR5202C HR5212C	1	135283-4	0088381359771	41,00
HR4003C	1	196792-8	0088381568678	27,00

Tipo 3

* Empuñadura completa



Modelos	Unds.	Código	EAN	P.V.P. (€)
DHR280	1	126882-3	-	16,40
DHP458	1	123257-7	3240890407412	14,00
DHP481	1	122D11-0	-	33,00
HM001G HM0870C HM0871C	1	135332-7	0088381367196	24,00
HR2020 HR2440 HR2450 HR2432	1	135302-6	0088381364430	4,00
HR2300 HR2600 HR2610 HR2610T HR2611FT	1	122878-2	0088381401463	14,00
HR3000C	1	134889-5	0088381152297	22,00
HR3200C HR3210C/FCT	1	135197-7	0088381349710	22,00
HR3540C HR3541FC HR4001C HR4011C HR4501C HR4511C	1	135209-6	0088381361828	22,00
HR4500C	1	134916-8	0088381160094	25,00
HR5001C	1	134881-1	0088381152921	28,00
HR5201C HR5211C	1	135380-6	0088381366243	25,00

Tipo 1



Tipo 2



Tipo 3



Taladrar

- Metal
- Madera
- Mampostería
- Cristal

Avellanar

Batir



Ezychange



Brocas de corona Unicut para mampostería y azulejo

Broca de corona



Ø (mm)	Largo (mm)	Modelos	Unds.	Código	EAN	P.V.P. (€)
25	60	Martillos ligeros hasta 26 mm	1	P-64462	0088381994989	31,00
30	60		1	P-64478	0088381994996	31,00
35	60		1	P-64484	0088381995009	35,00
40	60		1	P-64490	0088381995016	36,00
45	60		1	P-64509	0088381995023	37,00
50	60		1	P-64515	0088381995030	39,00
55	60		1	P-64521	0088381995047	41,00
58	60		1	P-64537	0088381995054	45,00
60	60		1	P-64543	0088381995061	45,00
63	60		1	P-64559	0088381995078	45,00
65	60		1	P-64565	0088381995085	46,00
68	60		1	P-64571	0088381995092	49,00
70	60	Martillos ligeros a partir de 28 mm	1	P-64587	0088381995108	56,00
71	60		1	P-64593	0088381995115	57,00
74	60		1	P-64602	0088381995122	58,00
76	60		1	P-64618	0088381995139	59,00
80	60		1	P-64630	0088381995153	61,00
85	60		1	P-64646	0088381995160	66,00
90	60		1	P-64652	0088381995177	68,00
105	60		1	P-64668	0088381995184	89,00

Adaptador para brocas UNICut



Ø (mm)	Largo (mm)	Unds.	Código	EAN	P.V.P. (€)
M16	118	1	P-64319	0088381994835	30,00
M16	370	1	P-64331	0088381994859	36,00

Broca de centrado para brocas Unicut



Ø (mm)	Largo (mm)	Punta	Unds.	Código	EAN	P.V.P. (€)
8	120	TCT	1	P-64347	0088381994866	6,70

UNICut

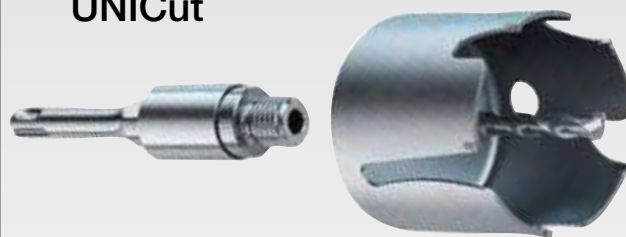

Las brocas UNICut son diseñadas para el empleo en una amplia gama de materiales:

- Albañilería con mampostería, ladrillos, azulejos, etc.
- Materiales ligeros como tabla de yeso, tabi, Fermacell, etc.
- En plástico, madera prensada, contrachapado, etc.

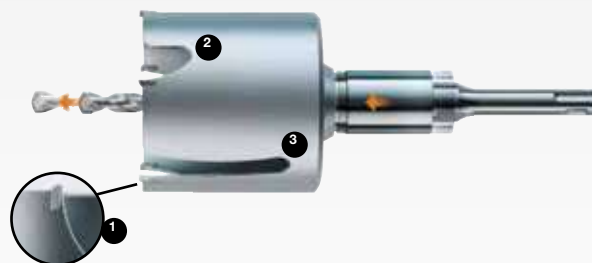

UNICut ¡ventajas convincentes!:

- 1** Robusta y duradera: Los dientes de carburo, con una superficie más amplia, soldados (1) de forma semejante al de una caja fuerte, aseguran y garantizan que los dientes no se desprenderán de la broca.
- 2** Rápida progresión taladrando: debido a la robusta estructura y corte agresivos.
- 3** Optimizando la vida del cuerpo: La vibración ha sido mejorada debido a la geometría especial de las cámaras de desalajo ampliadas (2) y la ranura de extracción de gases (3).



Brocas para ladrillo ★★



Ø (mm)	Largo (mm)	Unds.	Código	EAN	P.V.P. (€)
3	60	1	D-05228	0088381176453	1,25
4	70	1	D-05234	0088381176460	1,25
5	85	1	D-05240	0088381176477	1,25
6	100	1	D-05256	0088381176484	1,25
6	150	1	D-05262	0088381176491	1,25
7	100	1	D-05278	0088381176507	1,25
7	150	1	D-05284	0088381176514	1,25
8	110	1	D-05290	0088381176521	1,25
8	150	1	D-05309	0088381176538	1,25
9	150	1	D-05315	0088381176545	1,25
10	150	1	D-05321	0088381176552	1,55
11	150	1	D-05337	0088381176569	1,55
12	150	1	D-05343	0088381176576	2,15
13	150	1	D-05359	0088381176583	2,80
14	150	1	D-05365	0088381176590	2,80
15	150	1	D-05371	0088381176606	2,80
16	150	1	D-05387	0088381176613	3,10

Brocas para ladrillo TCT ★★★



Ø (mm)	Largo (mm)	Unds.	Código	EAN	P.V.P. (€)
3	60	1	E-06351	0088381569309	1,50
4	70	1	E-06367	0088381569316	1,50
5	85	1	E-06373	0088381569323	1,50
5	150	1	E-06389	0088381569330	1,50
6	100	1	E-06410	0088381569361	1,50
6	150	1	E-06426	0088381569378	1,50
8	110	1	E-06482	0088381569439	1,50
8	150	1	E-06498	0088381569446	1,50
10	150	1	E-06529	0088381569477	1,50
10	250	1	E-06535	0088381569484	3,05
12	150	1	E-06541	0088381569491	2,40
12	250	1	E-06557	0088381569507	3,30
14	150	1	E-06563	0088381569514	3,05
14	250	1	E-06579	0088381569521	4,20
16	150	1	E-06585	0088381569538	3,40
18	200	1	E-06591	0088381569545	4,90
20	200	1	E-06600	0088381569552	5,50

Brocas para ladrillo 1/4" hexagonal ★★



Ø (mm)	Largo (mm)	Unds.	Código	EAN	P.V.P. (€)
5	90	1	D-23793	0088381312882	2,10
6	100	1	D-23802	0088381312899	2,15
8	100	1	D-23818	0088381312905	2,90

Brocas punta de flecha 1/4" hexagonal ★★★



Ø (mm)	Largo (mm)	Unds.	Código	EAN	P.V.P. (€)
4	65	1	D-15942	0088381187107	2,80
5	65	1	D-15958	0088381187114	2,80
6	65	1	D-15964	0088381187121	3,05
8	70	1	D-15970	0088381187138	3,05
10	80	1	D-15986	0088381187145	3,70



Brocas multimaterial

OmnBohrer

★★



Ø (mm)	Largo (mm)	Largo útil (mm)	Unds.	Código	EAN	P.V.P. (€)
3	60	26	1	D-30287	0088381353151	0,90
4	70	36	1	D-30293	0088381353168	0,90
5	85	41	1	D-30302	0088381353175	0,90
5,5	100	56	1	D-31033	0088381355056	0,90
6	150	101	1	D-30324	0088381353199	0,95
6	250	170	1	D-72780	0088381577298	1,80
6,5	100	56	1	D-31061	0088381355087	0,95
7	150	101	1	D-30346	0088381353212	1,25
8	150	95	1	D-30368	0088381353236	1,25
9	150	95	1	D-30374	0088381353243	1,50
10	150	95	1	D-30380	0088381353250	1,55
12	150	91	1	D-30411	0088381353281	2,15
12	400	298	1	D-30427	0088381353298	4,60
13	150	83	1	D-30449	0088381353342	2,45
14	150	83	1	D-30455	0088381353311	2,80
14	400	298	1	D-30461	0088381353328	6,20

Brocas multimaterial

OmnBohrer

★★★



Ø (mm)	Largo (mm)	Largo útil (mm)	Unds.	Código	EAN	P.V.P. (€)
3	70	38	1	E-10958	0088381581615	1,60
4	75	40	1	E-10964	0088381581622	1,60
5	85	43	1	E-10970	-	1,70
5,5	100	50	1	E-10986	0088381581646	1,85
6	150	90	1	E-11003	0088381581660	2,20
6,5	150	90	1	E-11025	0088381581684	2,35
7	100	50	1	E-11031	0088381581691	2,20
8	150	90	1	E-11053	0088381581714	2,95
10	150	90	1	E-11069	0088381581721	3,50
12	150	90	1	E-11075	0088381581738	3,90
13	150	90	1	E-11081	0088381581745	4,80

Brocas multimaterial

OmnBohrer

Inserción 1/4" Hex

★★★



Ø (mm)	Largo (mm)	Unds.	Código	EAN	P.V.P. (€)
4/5/6/8/10 (estuche)	75/85/100/120/150	1	E-14255	0088381593526	12,80
3	90	1	E-14934	0088381594899	1,85
4	90	1	E-14940	0088381594905	1,85
5	100	1	E-14956	0088381594912	2,15
6	100	1	E-14984	0088381594943	2,40
6	150	1	E-14990	0088381594950	2,65
8	120	1	E-15045	0088381595001	3,20
8	150	1	E-15051	0088381595018	3,50
10	150	1	E-15067	0088381595025	4,00
12	150	1	E-15073	0088381595032	4,50
13	150	1	E-15089	0088381595049	5,40



Brocas estándar para madera

★★★

- Con punta centradora.



Ø (mm)	Largo (mm)	Largo útil (mm)	Unds.	Código	EAN	P.V.P. (€)
3	60	33	1	D-07026	0088381178587	0,95
4	75	43	1	D-07032	0088381178594	0,95
5	85	52	1	D-07048	0088381178600	0,95
6	95	57	1	D-07054	0088381178617	0,90
6	315	160	1	D-07157	0088381178716	3,30
7	110	69	1	D-07060	0088381178624	1,25
8	115	75	1	D-07076	0088381178631	1,25
8	315	160	1	D-07163	0088381178723	3,60
9	125	81	1	D-07082	0088381178648	1,55
10	135	87	1	D-07098	0088381178655	1,55
10	315	160	1	D-07179	0088381178730	4,40
12	155	101	1	D-07107	0088381178662	2,20
12	315	160	1	D-07185	0088381178747	5,30
13	151	96	1	D-53453	0088381449373	2,85
14	170	108	1	D-07113	0088381178679	2,80
14	315	160	1	D-07191	0088381178754	6,30
15	160	100	1	D-53469	0088381449380	3,50
16	180	105	1	D-07129	0088381178686	4,40
16	315	160	1	D-07200	0088381178761	7,50
18	200	120	1	D-07135	0088381178693	6,30
18	335	160	1	D-07216	0088381178778	10,10
20	200	130	1	D-07141	0088381178709	6,90
20	335	160	1	D-07222	0088381178785	12,60

Brocas helicoidales para madera

★★★

- Ideal para taladros pasantes.
- Gran extracción de viruta.
- Punta autorroscante.



Ø (mm)	Largo (mm)	Largo útil (mm)	Unds.	Código	EAN	P.V.P. (€)
6	250	180	1	D-07331	0088381178891	3,50
8	250	180	1	D-07347	0088381178907	3,60
8	450	380	1	D-07559	0088381179119	7,60
10	250	180	1	D-07353	0088381178914	5,60
10	450	380	1	D-07565	0088381179126	8,20
12	250	180	1	D-07369	0088381178921	6,10
12	450	380	1	D-07571	0088381179133	9,40
13	250	180	1	D-53475	0088381449397	6,40
13	450	380	1	D-53497	0088381449410	10,20
14	250	180	1	D-07375	0088381178938	7,00
14	450	380	1	D-07587	0088381179140	10,20
15	250	180	1	D-53481	0088381449403	7,00
15	450	380	1	D-53506	0088381449427	11,40
16	250	180	1	D-07381	0088381178945	7,30
16	450	380	1	D-07593	0088381179157	11,90
18	250	180	1	D-07397	0088381178952	8,20
18	450	380	1	D-07602	0088381179164	13,40
20	250	180	1	D-07406	0088381178969	8,50
20	450	380	1	D-07618	0088381179171	15,30
22	250	180	1	D-07412	0088381178976	9,00
22	450	380	1	D-07624	0088381179188	16,90
24	250	180	1	D-07428	0088381178983	9,60
24	450	380	1	D-07630	0088381179195	18,90
26	450	380	1	D-07646	0088381179201	22,00
28	450	380	1	D-07652	0088381179218	25,00
30	450	380	1	D-07668	0088381179225	29,00

Brocas estándar para madera 1/4" hexagonal

★★★



Ø (mm)	Largo (mm)	Largo útil (mm)	Unds.	Código	EAN	P.V.P. (€)
3	75	33	1	D-15861	0088381187022	1,25
4	90	43	1	D-15877	0088381187039	1,25
5	100	52	1	D-15883	0088381187046	1,55
6	110	57	1	D-15899	0088381187053	1,55
8	115	75	1	D-15908	0088381187060	2,20
10	130	87	1	D-15914	0088381187077	2,50
12	150	101	1	D-15920	0088381187084	3,40
15	160	108	1	D-15936	0088381187091	5,40

Brocas helicoidales para madera 1/4" hexagonal

★★★



Ø (mm)	Largo (mm)	Largo útil (mm)	Unds.	Código	EAN	P.V.P. (€)
6	200	130	1	D-15992	0088381187152	4,30
8	200	130	1	D-16003	0088381187169	4,90
10	200	130	1	D-16019	0088381187176	5,80
12	200	130	1	D-16025	0088381187183	6,20
14	200	130	1	D-16031	0088381187190	6,10
16	200	130	1	D-16047	0088381187206	6,30
18	200	130	1	D-16053	0088381187213	7,00
20	200	130	1	D-16069	0088381187220	8,10
21	200	130	1	D-16075	0088381187237	10,20



Brocas de pala para madera ★★

- Con punta centradora.
- Gran velocidad de taladrado.



Ø (mm)	Largo (mm)	Unds.	Código	EAN	P.V.P. (€)
6	150	1	D-07674	0088381179232	1,55
8	150	1	D-07680	0088381179249	1,55
10	150	1	D-07696	0088381179256	1,55
12	150	1	D-07705	0088381179263	1,85
13	150	1	D-67614	0088381549363	1,85
14	150	1	D-07711	0088381179270	1,85
15	150	1	D-07727	0088381179287	1,85
16	150	1	D-07733	0088381179294	1,85
18	150	1	D-07749	0088381179300	2,20
20	150	1	D-07755	0088381179317	2,20
22	150	1	D-07761	0088381179324	2,20
24	150	1	D-07777	0088381179331	2,85
25	150	1	D-07783	0088381179348	2,85
26	150	1	D-07799	0088381179355	2,85
28	160	1	D-07808	0088381179362	3,10
30	160	1	D-07814	0088381179379	3,40
32	160	1	D-07820	0088381179386	3,80
34	160	1	D-07836	0088381179393	4,10
35	160	1	D-07842	0088381179409	4,10
36	160	1	D-07858	0088381179416	4,40

Brocas de precisión Forstner para madera ★★

- Perforaciones perfectas, con menos rebabas.
- Menos ruido.
- Menos esfuerzo.
- Presentado en bote de plástico con gancho para colgar.
- El diseño de los dientes ofrece una alta precisión y un gran rendimiento.
- Punta centradora que permite un preciso inicio de taladrado.
- Medida marcada en la broca para reconocerla fácilmente.
- Puede utilizarse en taladros con portabrocas de 10mm y 13mm.



Ø (mm)	Largo (mm)	Unds.	Código	EAN	P.V.P. (€)
10	90	1	D-41844	0088381404648	6,60
15	90	1	D-41925	0088381404686	7,80
20	90	1	D-42232	0088381404693	8,90
25	90	1	D-42248	0088381404709	9,60
26	90	1	D-42254	0088381404716	10,20
30	90	1	D-42260	0088381404723	10,70
35	90	1	D-42282	0088381404747	11,90
40	90	1	D-42298	0088381404754	13,70
50	90	1	D-42307	0088381404761	18,80



Makita

Brocas autoalimentadas para madera

- Punta del tornillo roscado empuja la broca hacia la pieza de trabajo, proporcionando la autoalimentación rápida y fácil de usar.
- Para perforar agujeros de gran diámetro limpiamente.
- Tienen un tornillo de alimentación central.
- Rosca de barrena.
- Las espuelas de contorno definen con precisión el diámetro del orificio.

★★



D-74304



D-74407

Ø (mm)	Largo (mm)	Unds.	Código	EAN	P.V.P. (€)
25	127	1	D-74304	0088381587341	12,70
28	127	1	D-74310	0088381587358	14,90
32	127	1	D-74326	0088381587365	16,50
35	127	1	D-74332	0088381587372	17,70
38	127	1	D-74348	0088381587389	20,00
45	127	1	D-74354	0088381587396	24,00
51	127	1	D-74360	0088381587402	26,00
54	127	1	D-74376	0088381587419	29,00
57	127	1	D-74382	0088381587426	34,00
65	127	1	D-74398	0088381587433	39,00
76	127	1	D-74407	0088381587440	58,00
92	127	1	D-74413	0088381587457	67,00
117	127	1	D-74429	0088381587464	86,00

Puntas para brocas autoalimentadas

★★



Ø (mm)	Unds.	Código	EAN	P.V.P. (€)
25 - 65	1	D-74435	0088381587471	1,40
76 - 117	1	D-74441	0088381587488	1,40

Extensiones para brocas autoalimentadas

★★



Largo (mm)	Unds.	Código	EAN	P.V.P. (€)
140	1	D-74457	0088381587495	11,00
305	1	D-74463	0088381587501	13,20
457	1	D-74479	0088381587518	16,00



Brocas cilíndricas para metal

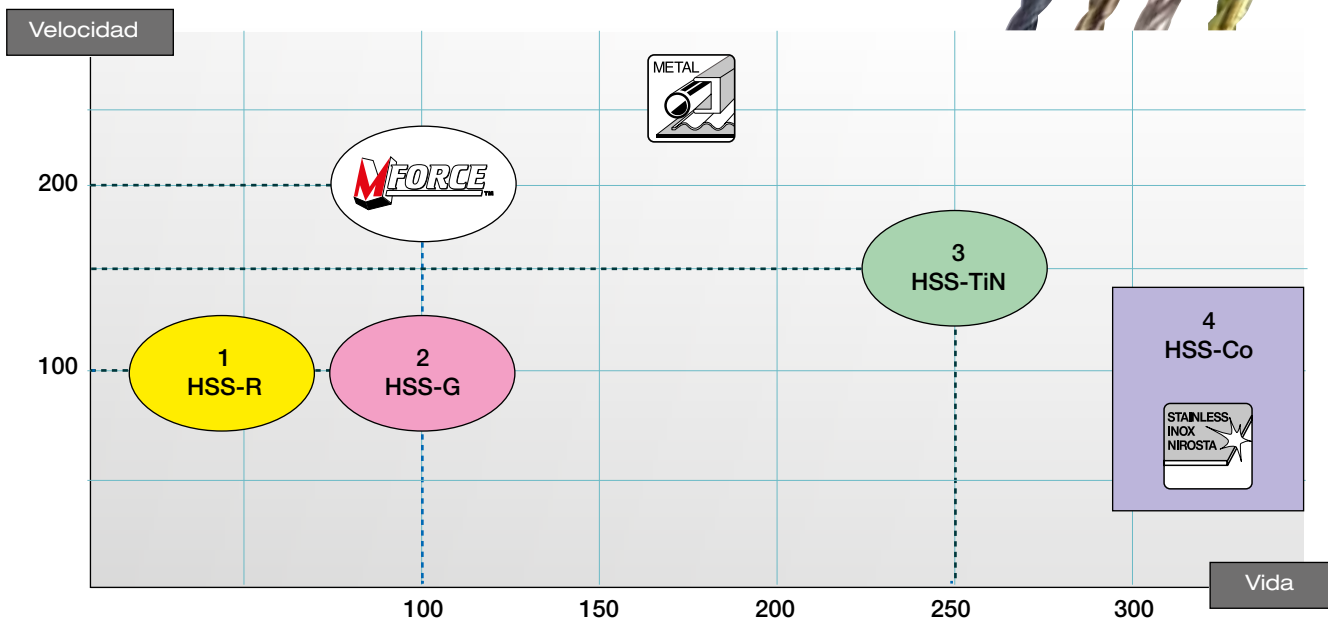

Descripción		A	B	C	D	E
		Material	Proceso de fabricación	Tipo de geometría	Acabado	Inserción
1	HSS-R	HSS	Laminada	118°	Negro	Cilíndrica
2	HSS-G	HSS	Rectificada	118°	Brillante	Cilíndrica
3	HSS-TiN	HSS	Rectificada	135°	Titanio	Cilíndrica o 1/4" hex.
4	HSS-Co	HSS-Co 5%	Rectificada	135°	Cobalto	Cilíndrica
5	M-FORCE	HSS - M-FORCE	Rectificada	M-FORCE	Titanio	Cilíndrica 3 Caras

Descripción		Material						
		Madera	Plástico	Metales no ferrosos	Chapa de acero	Hierro fundido	Acero	Acero inoxidable
1	HSS-R Broca de metal	◆	✓		◆	✓		
2	HSS-G Broca de metal	◆	✓	✓	✓	✓	✓	◆
3	HSS-TiN	◆	✓	✓	✓	✓	✓	◆
4	HSS-Co			◆	◆	✓	✓	✓
5	M-FORCE	◆	✓	✓	✓	✓	✓	◆

✓ : Recomendado ◆ : Válido



Makita

Brocas cilíndricas para metal

A Fabricado con...



Acero rápido



Acero rápido con un 5% de cobalto añadido.

Para una mayor resistencia a la abrasión y al calor. Ideal para taladrar metal duro.

B Tipo

HSS-R Laminadas



Hecho con metal fundido a presión. Es el proceso más económico. Bisel en los bordes de la espiral para una mejor evacuación de la viruta.

HSS-G Rectificadas

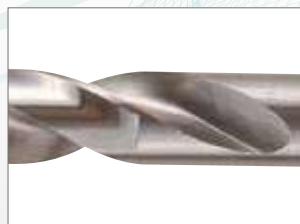

Tanto la espiral como el borde están fabricados del mismo bloque de metal, lo que proporciona a la broca una calidad superior. Biselado de la espiral para un corte más rápido y eficaz.

C Geometría de la punta

HSS-R y HSS-G

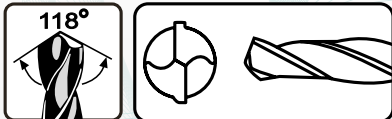

HSS-TIN y HSS-Co

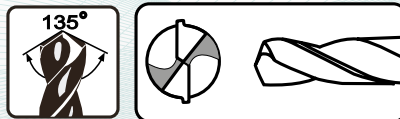

M-FORCE

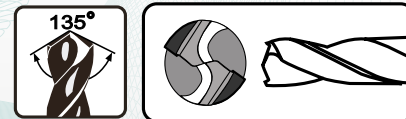

El ángulo de 135° consigue que el inicio de la perforación sea más sencilla y evita que la broca patine.

Brocas con un punto de autocentrado en forma de M que evita su desplazamiento para una perforación más precisa.

D Acabado

Acabado negro



Acabado brillante



Acabado titanio



Acabado cobalto



Duran hasta un 150% más que otras brocas.

Alta calidad con un 5% de cobalto

E Inserción

Recto (cilíndrico)



Hexagonal 1/4"



Cilíndrico (3 caras)



Puede utilizarse con un portabrocas de 1/4". Permite que el cambio de brocas sea más sencillo.

Tres ejes planos en el vástago. Evita el deslizamiento de la broca



Brocas para metal HSS-R DIN338



- Brocas indicadas para el taladrado de acero con resistencia máxima de 900 N/mm², hierro fundido, plásticos y metales no ferrosos.
- Mínimo riesgo de rotura para diámetros pequeños gracias a la posibilidad de flexión del material.
- Espiral con dos salidas para una efectiva evacuación del material sobrante.
- Brocas para corte en metal con un ángulo en la punta de 118°.
- Bisel en los bordes de la espiral para una mejor evacuación de la viruta.

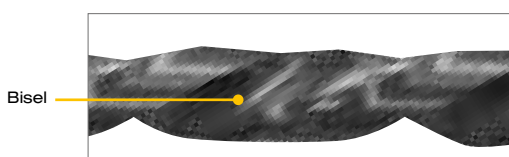

- Blíster con dos Unds. en las brocas con medidas comprendidas entre 1.5 – 4.0mm.
- Brocas de categoría estándar con muy buena relación calidad precio.

Ø (mm)	Largo (mm)	Largo útil (mm)	Unds.	Código	EAN	P.V.P. (€)
1,5	40	18	2	D-38299	0088381398787	1,25
2,0	49	24	2	D-38308	0088381398794	1,25
2,5	57	30	2	D-38314	0088381398800	1,20
3,0	61	33	2	D-38336	0088381398824	1,25
3,5	70	39	2	D-38358	0088381398848	1,25
4,0	75	43	2	D-38364	0088381398855	1,25
4,5	80	47	1	D-38386	0088381398879	0,90
5,0	86	52	1	D-38401	0088381398893	0,90
5,5	93	57	1	D-38417	0088381398909	0,90
6,0	93	57	1	D-38423	0088381398916	0,90
6,5	101	63	1	D-38439	0088381398923	1,25
7,0	109	69	1	D-38445	0088381398930	1,25
7,5	109	69	1	D-38451	0088381398947	1,25
8,0	117	75	1	D-38467	0088381398954	1,50
8,5	117	75	1	D-38473	0088381398961	1,50
9,0	125	81	1	D-38489	0088381398978	1,80
10,0	133	87	1	D-38495	0088381398985	2,15
11,0	142	94	1	D-38504	0088381398992	2,75
12,0	151	101	1	D-38510	0088381399005	3,30
13,0	151	101	1	D-38526	0088381399012	3,60

Brocas para metal HSS-G DIN338



- Brocas indicadas para el taladrado de acero con resistencia máxima de 900 N/mm², metales de fundición, plásticos duros y metales no ferrosos.
- Ofrece una perforación más rápida y una vida útil superior.
- Espiral con dos salidas para una efectiva evacuación del material sobrante.
- Excelente calidad del acero con la que está realizada esta broca.
- Brocas para corte en metal con un ángulo en la punta de 135°.
- Biselado de la espiral para una corte más rápido y eficaz.
- Brocas de buena calidad para aplicaciones profesionales.

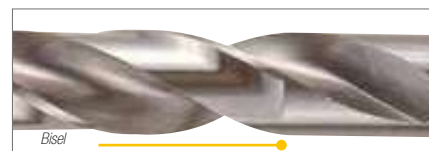

Ø (mm)	Largo (mm)	Largo útil (mm)	Unds.	Código	EAN	P.V.P. (€)
1,5	40	18	1	D-09656	0088381184922	0,90
2,0	49	24	1	D-09662	0088381184939	0,85
2,5	57	30	1	D-09678	0088381184946	0,90
3,0	61	33	1	D-09684	0088381184953	0,90
3,5	70	39	1	D-09690	0088381184960	1,20
4,0	75	43	1	D-09709	0088381184977	1,20
4,5	80	47	1	D-09715	0088381184984	1,30
5,0	86	52	1	D-09721	0088381184991	1,55
5,5	93	57	1	D-09737	0088381185004	1,75
6,0	93	57	1	D-09743	0088381185011	1,85
6,5	101	63	1	D-09759	0088381185028	2,05
7,0	109	69	1	D-09765	0088381185035	2,40
7,5	109	69	1	D-09771	0088381185042	2,65
8,0	117	75	1	D-09787	0088381185059	3,50

Ø (mm)	Largo (mm)	Largo útil (mm)	Unds.	Código	EAN	P.V.P. (€)
8,5	117	75	1	D-09793	0088381185066	3,20
9,0	125	81	1	D-09802	0088381185073	3,80
9,5	125	81	1	D-09818	0088381185080	4,10
10,0	133	87	1	D-09824	0088381185097	4,70
10,5	133	87	1	D-09830	0088381185103	6,10
11,0	142	94	1	D-09846	0088381185110	6,40
11,5	142	94	1	D-09852	0088381185127	7,00
12,0	151	101	1	D-09868	0088381185134	7,60
12,5	151	101	1	D-09874	0088381185141	8,10
13,0	151	101	1	D-09880	0088381185158	8,80
14	160	108	1	D-74893	0088381593786	20,00
15	169	114	1	D-74902	0088381593793	23,00
16	178	120	1	D-74918	0088381593809	26,00

Brocas para metal HSS-TIN DIN338



- Brocas indicadas para el taladrado de acero con resistencia máxima de 900 N/mm², metales de fundición, plásticos duros y metales no ferrosos.
- Brocas recubiertas de nitrato de titanio que reduce la fricción y consigue mayor duración de la vida de la broca.
- Brocas un 40% más rápidas que nuestra gama HSS-G.
- Una duración mayor en un 150% respecto a nuestra gama HSS-G.
- Brocas para corte en metal con un ángulo en la punta de 135°, favorece la entrada en el material consiguiendo mayor velocidad de taladrado.
- Biselado de la espiral para un corte más rápido y eficaz.
- Brocas de gran calidad para aplicaciones profesionales donde se necesite mayor velocidad.

Ø (mm)	Largo (mm)	Largo útil (mm)	Unds.	Código	EAN	P.V.P. (€)
1,5	40	18	2	D-64010	0088381530453	1,35
2	49	24	2	D-64026	0088381530460	1,35
2,5	57	30	2	D-64032	0088381530477	1,35
3	61	33	2	D-64048	0088381530484	1,35
3,5	70	39	2	D-64054	0088381530491	1,35
4	75	43	2	D-64060	0088381530507	1,35
4,5	80	47	1	D-64076	0088381530514	1,35
5	86	52	1	D-64082	0088381530521	1,35
5,5	93	57	1	D-64098	0088381530538	1,35
6	93	57	1	D-64107	0088381530545	1,35
6,5	101	63	1	D-64113	0088381530552	1,50
7	109	69	1	D-64129	0088381530569	1,75
7,5	109	69	1	D-64135	0088381530576	1,75
8	117	75	1	D-64141	0088381530583	2,00
8,5	117	75	1	D-64157	0088381530590	2,25
9	125	81	1	D-64163	0088381530606	2,25
9,5	125	81	1	D-64179	0088381530613	2,50
10	133	87	1	D-64185	0088381530620	2,75
10,5	133	87	1	D-64191	0088381530637	3,00
11	142	94	1	D-64200	0088381530644	3,25
11,5	142	94	1	D-64216	0088381530651	3,50
12	151	101	1	D-64222	0088381530668	4,00
12,5	151	101	1	D-64238	0088381530675	4,00
13	151	101	1	D-64244	0088381530682	4,25

Brocas para metal HSS-TIN 1/4" hexagonal



- Brocas indicadas para el taladrado de acero con resistencia máxima de 1.000 N/mm², aceros tratados, aceros inoxidables y metales de fundición.
- Brocas de gran duración, indicadas para los trabajos de precisión.
- Ideal para trabajos en soportes para taladros.
- Fabricadas con metal de alta calidad con un 5% de cobalto añadido.
- Brocas para corte en metales con un ángulo en la punta de 118°, que reduce el riesgo de desplazamientos de la broca durante el taladrado.
- Estas brocas son las perfectas para los trabajos más exigentes:
 - Acero Inoxidable.
 - Trabajos en todo tipo de carrocerías de automóviles.
 - Cordones de soldadura.

Ø (mm)	Largo (mm)	Largo útil (mm)	Unds.	Código	EAN	P.V.P. (€)
3,0	81	33	1	D-14928	0088381185967	1,75
3,2	85	36	1	D-14934	0088381185974	2,05
4,0	95	43	1	D-14940	0088381185981	2,05
5,0	106	52	1	D-14962	0088381186001	2,35
6,0	113	57	1	D-14978	0088381186018	3,20
6,5	121	63	1	D-17778	0088381200622	4,40
8,0	117	75	1	D-15827	0088381186988	6,10
10,0	133	87	1	D-15833	0088381186995	9,30
12,0	151	101	1	D-15849	0088381187008	12,30
13,0	151	101	1	D-15855	0088381187015	15,70

Broca remachadora HSS



Ø (mm)	Largo (mm)	Largo útil (mm)	Unds.	Código	EAN	P.V.P. (€)
3,3	50	20	10	B-56437	0088381490283	12,80

Brocas para metal HSS-CO DIN338 ★★★★★

- Brocas para el taladrado de acero con resistencia máxima de 1.000 N/mm², aceros tratados, aceros inoxidables y metales de fundición.
- Gran duración, indicadas para los trabajos de precisión. Ideal para trabajos en soportes para taladros.
- Fabricadas con metal de alta calidad con un 5% de cobalto añadido.



Ø (mm)	Largo (mm)	Largo útil (mm)	Unds.	Código	EAN	P.V.P. (€)
1,5	40	18	1	D-17289	0088381195942	1,45
2,0	49	24	1	D-17295	0088381195959	1,45
2,5	57	30	1	D-17304	0088381195966	1,50
3,0	61	33	1	D-17310	0088381195973	1,55
3,5	70	39	1	D-17332	0088381195997	1,55
4,0	75	43	1	D-17348	0088381196000	1,75
4,5	80	47	1	D-17354	0088381196017	2,05
5,0	86	52	1	D-17360	0088381196024	2,10
5,5	93	57	1	D-17376	0088381196031	2,60
6,0	93	57	1	D-17382	0088381196048	2,75
6,5	101	63	1	D-17398	0088381196055	3,20
7,0	109	69	1	D-17407	0088381196062	3,70
7,5	109	69	1	D-17413	0088381196079	5,00
8,0	117	75	1	D-17429	0088381196086	6,10
8,5	117	75	1	D-17435	0088381196093	6,40
9,0	125	81	1	D-17441	0088381196109	6,40
9,5	125	81	1	D-17457	0088381196116	8,60
10,0	133	87	1	D-17463	0088381196123	9,70
10,5	133	87	1	D-17479	0088381196130	10,80
11,0	142	94	1	D-17485	0088381196147	11,10
11,5	142	94	1	D-17491	0088381196154	13,90
12,0	151	101	1	D-17500	0088381196161	14,00
12,5	151	101	1	D-17516	0088381196178	16,60
13,0	151	101	1	D-17522	0088381196185	17,80

Brocas metal para SDS-PLUS ★★★★★



Ø (mm)	Largo (mm)	Largo útil (mm)	Unds.	Código	EAN	P.V.P. (€)
3	90	33	1	B-57401	0088381519014	3,50
3,5	100	39	1	B-57417	0088381519021	3,50
4	105	43	1	B-57423	0088381519038	4,10
4,5	110	47	1	B-57439	0088381519045	4,10
5	116	52	1	B-57445	0088381519052	5,00
5,5	123	5	1	B-57451	0088381519069	5,00
6	123	57	1	B-57467	0088381519076	5,00
6,5	131	63	1	B-57473	0088381519083	5,60

Brocas madera para SDS-PLUS ★★★



Ø (mm)	Largo (mm)	Largo útil (mm)	Unds.	Código	EAN	P.V.P. (€)
4	105	43	1	B-57489	0088381519090	3,70
5	116	52	1	B-57495	0088381519106	3,80
6	123	57	1	B-57504	0088381519113	3,70
8	147	75	1	B-57510	0088381519120	4,40
10	163	87	1	B-57526	0088381519137	4,70

Estuche brocas madera metal SDS-PLUS



Descripción	Unds.	Código	EAN	P.V.P. (€)
Juego brocas SDS-PLUS madera y metal	1	B-57532	0088381519144	14,80

Brocas cónicas ★★★

A Tipo



B Superficie

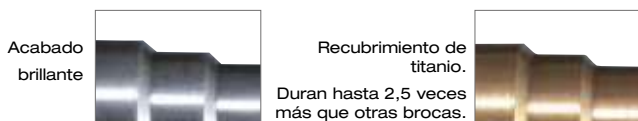

C Inserción



Ø (mm)	Flauta	Tipo	Unds.	Código	EAN	P.V.P. (€)
3-14	Recta	HSS	1	D-40048	0088381400244	19,10
4-20	Recta	HSS	1	D-40054	0088381400251	29,00
16-30,5	Recta	HSS	1	D-40060	0088381400268	54,00
24-40	Recta	HSS	1	D-40076	0088381400275	96,00

Brocas cónicas escalonadas



Ø (mm)	Flauta	Tipo	Unds.	Código	EAN	P.V.P. (€)
4-32	Recta	HSS	1	D-40107	0088381400305	73,00
4-32	Recta	HSS-TIN	1	D-40135	0088381400336	83,00
4-32	Espiral	HSS	1	D-40163	0088381400367	78,00
4-32	Espiral	HSS-TIN	1	D-40191	0088381400398	95,00



Brocas para taladro magnético HB500 y HB350

- Espiral para una buena evacuación de la rebaba. Punta de centrado que ayuda a la extracción del material una vez taladrado.
- Inserción universal de 19mm.

















Ø (mm)	Largo (mm)	Largo útil (mm)	Unds.	Código	EAN	P.V.P. (€)
12	30	19	1	12S	-	24,00
12	50	19	1	12L	-	32,00
13	30	19	1	13S	-	24,00
13	50	19	1	13L	-	33,00
14	30	19	1	14S	-	24,00
14	50	19	1	14L	-	34,00
15	30	19	1	15S	-	25,00
15	50	19	1	15L	-	35,00
16	30	19	1	16S	-	26,00
16	50	19	1	16L	-	36,00
17	30	19	1	17S	-	26,00
17	50	19	1	17L	-	37,00
18	30	19	1	18S	-	26,00
18	50	19	1	18L	-	40,00
19	30	19	1	19S	-	27,00
19	50	19	1	19L	-	42,00
20	30	19	1	20S	-	29,00
20	50	19	1	20L	-	44,00
21	30	19	1	21S	-	30,00
21	50	19	1	21L	-	47,00
22	30	19	1	22S	-	31,00
22	50	19	1	22L	-	47,00
23	30	19	1	23S	-	32,00
23	50	19	1	23L	-	49,00
24	30	19	1	24S	-	33,00
24	50	19	1	24L	-	51,00
25	30	19	1	25S	-	37,00
25	50	19	1	25L	-	54,00
26	30	19	1	26S	-	39,00
26	50	19	1	26L	-	57,00
27	30	19	1	27S	-	40,00
27	50	19	1	27L	-	60,00
28	30	19	1	28S	-	45,00
28	50	19	1	28L	-	61,00
29	30	19	1	29S	-	46,00
29	50	19	1	29L	-	64,00
30	30	19	1	30S	-	47,00
30	50	19	1	30L	-	67,00
31	30	19	1	31S	-	48,00
31	50	19	1	31L	-	70,00

Ø (mm)	Largo (mm)	Largo útil (mm)	Unds.	Código	EAN	P.V.P. (€)	
32	30	19	1	32S	-	49,00	
32	50	19	1	32L	-	73,00	
33	30	19	1	33S	-	50,00	
33	50	19	1	33L	-	78,00	
34	30	19	1	34S	-	52,00	
34	50	19	1	34L	-	79,00	
35	30	19	1	35S	-	57,00	
35	50	19	1	35L	-	82,00	
36	30	19	1	36S	-	56,00	
36	50	19	1	36L	-	86,00	
37	30	19	1	37S	-	58,00	
37	50	19	1	37L	-	89,00	
38	30	19	1	38S	-	62,00	
38	50	19	1	38L	-	90,00	
39	30	19	1	39S	-	63,00	
39	50	19	1	39L	-	100,00	
40	30	19	1	40S	-	72,00	
40	50	19	1	40L	-	105,00	
41	30	19	1	41S	-	73,00	
41	50	19	1	41L	-	109,00	
42	30	19	1	42S	-	74,00	
42	50	19	1	42L	-	111,00	
43	30	19	1	43S	-	76,00	
43	50	19	1	43L	-	114,00	
44	30	19	1	44S	-	78,00	
44	50	19	1	44L	-	119,00	
45	30	19	1	45S	-	79,00	
45	50	19	1	45L	-	133,00	
46	30	19	1	46S	-	88,00	
46	50	19	1	46L	-	137,00	
47	30	19	1	47S	-	90,00	
47	50	19	1	47L	-	146,00	
48	30	19	1	48S	-	91,00	
48	50	19	1	48L	-	151,00	
49	30	19	1	49S	-	94,00	
49	50	19	1	49L	-	153,00	
50	30	19	1	50S	-	96,00	
50	50	19	1	50L	-	155,00	
				Broca centradora 30mm	PILOTS	-	7,70
				Broca centradora 50mm	PILOTL	-	9,60



Avellanadores multimaterial

✓ : Recomendado

Descripción	A	B	C	Material					
	Fabricado con	Tipo	Inserción	Madera	Plástico	Metales no ferrosos	Hierro fundido	Acero	Acero inoxidable
7 filos 			1/4" Hex	✓	✓	✓	✓		
3 filos 			1/4" Hex (Forma-C)	✓	✓	✓	✓	✓	
5 filos 			Inserción cilíndrica	✓	✓	✓	✓	✓	
3 filos 			Inserción cilíndrica	✓	✓	✓	✓	✓	
			Inserción cilíndrica		✓	✓	✓	✓	✓

A Fabricado en Acero



HSS



Acero rápido con un 5% de Cobalto. Proporciona mayor dureza y resistencia a la abrasión. ideal para metales duros.

HSS-Co

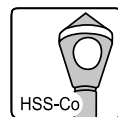

B Tipo

Avellanador cónico superficial.



Avellanador cónico superficial. Idóneo para láminas finas.



Avellanador cónico con vástago largo. Perfecto para avellanados de difícil acceso.



C Inserción Cilíndrica



1/4" Hexagonal



Avellanadores multimaterial

- Gama de avellanadores multimaterial, válidos para metal, metales no ferrosos y válidos también para madera. El avellanado es un proceso intermedio entre el taladrado y el atornillado. Se utiliza para el desarrollo de ensamblajes embutiendo la cabeza del tornillo utilizado dentro del material taladrado.
- Una vez taladrado el material se elige el avellanador más adecuado al tornillo que vamos a atornillar.
- Una vez realizado el avellanado ya podemos proceder al atornillado hasta que la cabeza del tornillo quede totalmente en línea con la superficie del material.
- Otro de los trabajos que podemos realizar con los avellanadores es la limpieza de la rebaba interior que queda en un tubo después del corte.

Avellanador cónico de acero con vástago 1/4" hexagonal

Metal, metales no ferrosos y madera.



★★

Ø (mm)	Avellanado	Longitud (mm)	Filos	Tipo	Unds.	Código	EAN	P.V.P. (€)
13	90°	50	7	Acero	1	D-37306	0088381376105	4,90

Avellanador cónico de HSS con vástago 1/4" hexagonal.

Metal, metales no ferrosos y madera.



★★★

Ø (mm)	Avellanado	Longitud (mm)	Filos	Tipo	Unds.	Código	EAN	P.V.P. (€)
6,3	M3	31	3	HSS	1	D-37312	0088381376112	6,40
8,3	M4	31	3	HSS	1	D-37328	0088381376129	7,60
10,4	M5	34	3	HSS	1	D-37334	0088381376136	8,80
12,4	M6	35	3	HSS	1	D-37340	0088381376143	9,30
16,5	M8	40	3	HSS	1	D-37356	0088381376150	14,00
20,5	M10	41	3	HSS	1	D-37362	0088381376167	16,90

Avellanador cónico de HSS con vástago cilíndrico 6mm.

Metal, metales no ferrosos y madera.



★★★

Ø (mm)	Avellanado	Longitud (mm)	Filos	Tipo	Unds.	Código	EAN	P.V.P. (€)
6	M3	48	5	HSS	1	D-37378	0088381376174	6,40
8	M4	48	5	HSS	1	D-37384	0088381376181	7,00
10	M5	40	5	HSS	1	D-37390	0088381376198	8,70
12	M6	40	5	HSS	1	D-37409	0088381376204	9,90
16	M8	43	5	HSS	1	D-37415	0088381376211	11,70
20	M10	45	5	HSS	1	D-37421	0088381376228	15,70

Avellanador cónico de HSS con vástago cilíndrico 5-6-8-10mm.

Metal, metales no ferrosos y madera.



★★★

Ø (mm)	Avellanado	Longitud (mm)	Filos	Tipo	Unds.	Código	EAN	P.V.P. (€)
6,3	M3	45	3	HSS	1	D-37437	0088381376235	6,40
8,3	M4	50	3	HSS	1	D-37443	0088381376242	8,10
10,4	M5	50	3	HSS	1	D-37459	0088381376259	9,40
12,4	M6	56	3	HSS	1	D-37465	0088381376266	10,00
16,5	M8	60	3	HSS	1	D-37471	0088381376273	13,40
20,5	M10	63	3	HSS	1	D-37487	0088381376280	17,50
25	M12	67	3	HSS	1	D-37493	0088381376297	22,00

Avellanador con orificio oblicuo HSS-Co 5% con vástago cilíndrico 6-8-10-12mm.



★★★★

Ø (mm)	Avellanado	Longitud (mm)	Filos	Tipo	Unds.	Código	EAN	P.V.P. (€)
2-5	90°	45	Agujero	HSS-Co	1	D-37502	0088381376303	11,70
5-10	90°	48	Agujero	HSS-Co	1	D-37518	0088381376310	19,10
10-15	90°	65	Agujero	HSS-Co	1	D-37524	0088381376327	29,00
15-20	90°	85	Agujero	HSS-Co	1	D-37530	0088381376334	51,00



Estuche de brocas para metal HSS-Co

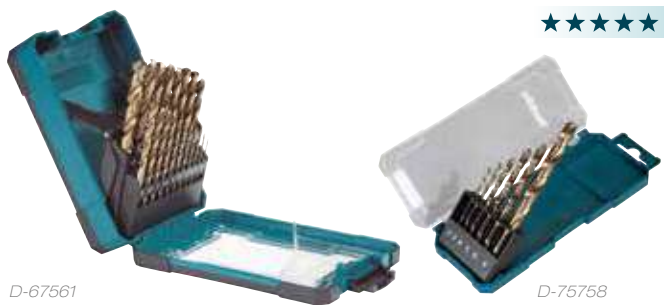

★★★★★

D-67561

D-75758

Ø (mm)	Contenido	Unds.	Código	EAN	P.V.P. (€)
de 1 a 10mm	19 piezas	1	D-67561	0088381549196	62,00
de 2 a 8mm	6 piezas	1	D-75758	0088381597241	15,50

Estuche de brocas para metal M-Force



★★★★★

Ø (mm)	Contenido	Unds.	Código	EAN	P.V.P. (€)
de 1 a 10mm	19 piezas	1	D-67583	0088381549219	66,00

Estuche de brocas para metal HSS-G



★★★

D-67549

D-75742

Ø (mm)	Contenido	Unds.	Código	EAN	P.V.P. (€)
de 1 a 10mm	19 piezas	1	D-67549	0088381549172	49,00
de 2 a 8mm	6 piezas	1	D-75742	0088381597234	10,70

Estuche de brocas para metal HSS-TiN



★★

Ø (mm)	Contenido	Unds.	Código	EAN	P.V.P. (€)
de 1 a 10mm	19 piezas	1	D-67527	0088381548243	25,00

Estuche de brocas para metal HSS-TiN



★★

Ø (mm)	Contenido	Unds.	Código	EAN	P.V.P. (€)
de 2 a 8mm	6 piezas	1	D-72833	0088381577342	6,40

Estuche de brocas para metal HSS-R



★

Ø (mm)	Contenido	Unds.	Código	EAN	P.V.P. (€)
de 1 a 10mm	19 piezas	1	D-54081	0088381450201	19,40

Estuche de brocas para ladrillo



★★



★★★★



★★

D-72877

E-11536

D-73483

Ø (mm)	Contenido	Unds.	Código	EAN	P.V.P. (€)
4, 5, 6, 8 y 10 mm	5 piezas	1	D-72877	0088381577380	5,80
4, 5, 6, 8 y 10 mm	5 piezas	1	E-11536	0088381582827	8,20
4 - 5 - 5,5 - 6 - 6,5 - 7 - 8	12 piezas	1	D-73483	0088381584845	13,80



Estuche de brocas para metal, ladrillo y madera

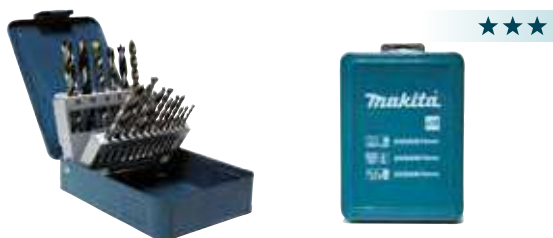

Contenido	Total	Unds.	Código	EAN	P.V.P. (€)
6 metal	18 piezas	1	D-46202	0088381411776	23,00
6 madera					
6 ladrillo					



Contenido	Total	Unds.	Código	EAN	P.V.P. (€)
3 metal	9 piezas	1	D-71962	0088381566490	8,50
3 madera					
3 ladrillo					

Estuche de brocas para madera



Ø (mm)	Contenido	Unds.	Código	EAN	P.V.P. (€)
de 4 a 10mm	5 piezas	1	D-72861	0088381577373	5,30

Juego de brocas de pala para madera



Ø (mm)	Contenido	Unds.	Código	EAN	P.V.P. (€)
de 12 a 32mm	8 piezas	1	E-08698	0088381579605	22,00

Estuche de brocas 1/4" hexagonal

- Madera
- Metal



Contenido	Total	Unds.	Código	EAN	P.V.P. (€)
3 metal	5 piezas	1	D-20769	0088381287760	12,90
2 madera					

- Madera
- Metal
- Ladrillo



Contenido	Total	Unds.	Código	EAN	P.V.P. (€)
2 metal	5 piezas	1	D-23759	0088381312844	10,20
2 madera					
1 ladrillo					

Estuche de brocas Omnibohrer Multimaterial



- Brocas para taladrar todo tipo de materiales ligeros como ladrillo, madera, aluminio, plástico y hormigón.
- Válidas para taladros de 2 modos. Taladro y taladro + percusión.
- Las brocas Omnibohrer de Makita son más duraderas que las brocas multimaterial de sus competidores.

Material	Hormigón	Azulejo	Ladrillo	Pizarra	Calza	Madera	Madera + plástico	Plástico	Aluminio	Metal
Simbolo										
Modo										
Válido	○	○	○	○	○	○	○	○	△(*)	×

○ Excelente △ Bueno × No recomendable

Ø (mm)	Longitud (mm)	Unds.	Código	EAN	P.V.P. (€)
5	85	1	D-30477	0088381353335	7,10
6	100	1			
8	110	1			
10	150	1			
12	150	1			



Estuche de puntas y brocas cilíndricas

★★★



Contenido	Unds	Código	EAN	P.V.P. (€)
29 piezas	1	E-07054	0088381571258	26,00

Estuche de puntas y brocas SDS-PLUS

★★★



Contenido	Unds	Código	EAN	P.V.P. (€)
18 piezas	1	E-07026	0088381571227	31,00

Set de puntas, vasos + avellanador

★★



Contenido	Unds	Código	EAN	P.V.P. (€)
Puntas, avellanadores, portabrocas magnético, llaves de vaso...	1	D-73461	0088381584821	32,00

Set de puntas + avellanador

★★



Contenido	Unds.	Código	EAN	P.V.P. (€)
Puntas, avellanadores y portabrocas magnético...	1	D-73477	0088381584838	30,00

Estuches de brocas y puntas

★★★



- 4 brocas de mampostería: 4 x 75mm, 5 x 85mm, 6 x 100mm, 8 x 120mm.
- 4 brocas para metal: 3 x 65mm, 4 x 75mm, 5 x 85mm, 6 x 95mm.
- 8 puntas de 25mm: PH2, PZ2, PH3, PZ3, Plana de 0.8 x 5.5 Plana de 1,2 x 6.5 T20, T25.
- Portapuntas magnético.

Contenido	Unds.	Código	EAN	P.V.P. (€)
17 piezas	1	D-40200	0088381401869	16,00

Nuevo



- 7 puntas 1/4" hex: PH1, PH2, PH3, PZ1, PZ2, PZ3, SL5
- Portabrocas de 60mm.
- Brocas HSS-Tin (5, 6 y 8mm).
- Brocas madera (5, 6 y 8mm).
- Brocas hormigón (5, 6 y 8mm).

Contenido	Unds.	Código	EAN	P.V.P. (€)
17 piezas	1	D-74887	0088381592123	17,10

★★★



- Puntas 25 mm PH, PZ y T.
- Puntas 50 mm PH, PZ y T.
- Brocas pala 10 - 25 mm.
- Brocas HSS-R 1,5 - 6 mm.

Contenido	Unds.	Código	EAN	P.V.P. (€)
71 piezas	1	B-50295	0088381463317	41,00

Set de brocas con avellanador 4pcs

★★



Ø (mm)	Unds.	Código	EAN	P.V.P. (€)
6 - 8 - 10 - 12	1	D-73455	0088381584722	9,40

Maletines de accesorios



★★★

- 30 Puntas 25 mm PH, PZ, T, SL y H.
- 20 Puntas 50 mm PH, PZ, T, SL y H.
- Portabrocas magnético.
- 13 llaves de vaso.
- Llave hexagonal.
- Punzón central.
- Avellanador.
- Brocas madera 3,4,5, 5.5, 6, 6.5.
- Adaptador de corona.
- Brocas para metal HSS- TiN: 3, 4, 5, 5.5, 6, 6.5mm.
- Brocas para mampostería: 3, 4, 5, 5.5, 6, 6.5mm.
- Brocas planas hexagonales: 12, 16, 19mm.
- 4 brocas de corona: 32, 38, 40, 54mm.
- Nivel.
- Cinta métrica 3 m.
- Medidor de diámetro.
- Punta para yeso.

Contenido	Unds.	Tipo	Código	EAN	P.V.P. (€)
102 piezas	1	***	E-10730	0088381580557	58,00



★★★

- Brocas HSS-TiN: 1, 1.5, 2, 2.5, 3, 3.5, 4, 4.5, 5, 5.5, 6, 6.5 y 7 mm
- Brocas para mampostería: 3, 4, 5, 5.5, 6, 6.5, 7, 8, 9 y 10mm
- Brocas para madera: 3, 4, 5, 6, 8 y 10 mm.
- Puntas 25 mm: PH - PZ - SL, Hex y T.
- Puntas 50 mm: PH -PZ - SL - Hex y T.
- Llaves de vaso.
- Punta Magnética para pladur 30 mm.
- Portapuntas magnético 60 mm.
- Avellanador 36 mm.
- Topes de profundidad: 3 - 5 y 8mm
- Llave allen 2,5 mm.
- Calibre para brocas.

Contenido	Unds.	Tipo	Código	EAN	P.V.P. (€)
102 piezas	1	***	B-68432	0088381546072	47,00



★★★

- Brocas de metal 1 - 1,5 - 2 - 2,5 - 3 - 3,2 - 3,5 - 4 - 4,5 - 5 - 5,5 - 6 - 6,5 - 7 - 7,5 - 8 - 9 y 10 mm.
- Brocas para mampostería: 3 - 4 - 4,5 - 5 - 5,5 - 6 - 6,5 - 7 - 8 y 10 mm.
- Brocas para madera: 3 - 4 - 5 - 6 - 7 - 8 - 9 y 10 mm.
- Brocas de pala para madera: 10 - 12 - 16 - 18 - 20 - 22 - 25 - 12 y 14 mm.
- Puntas 25 mm: PH - PZ - SL - Hex - T y SQ.
- Puntas 50 mm: PH - PZ - SL y Hex.
- Llaves de vaso.
- Avellanador 12,7 mm.
- Portapuntas magnético 60 mm.
- Topes de profundidad: 3 - 5 - 6 - 8 y 10 mm.
- Llave allen 2,5 mm.
- Calibre para brocas.
- Brocas de corona con adaptador (mm): 32 - 38 - 44 - 54.
- Metro Makita 3mx13mm.
- Nivel.
- Destornillador magnético manual y destornillador manual.
- Botadores.
- Lápiz de carpintero.
- Portapuntas flexible.

Contenido	Unds.	Tipo	Código	EAN	P.V.P. (€)
212 piezas	1	***	E-06270	0088381568746	104,00



★★★

- Brocas de metal HSS-R: 1 - 1,5 - 2 - 2,5 - 3 - 3,2 - 3,5 - 4 - 4,5 - 5 - 5,5 - 6 - 7 - 7,5 y 8 mm
- Brocas para madera: 3 - 4 - 5 - 6 - 7 - 8 - 9 y 10 mm.
- Brocas de pala para madera: 12 - 16 - 20 - 22 - 25 - 12 y 14mm.
- Brocas para mampostería: 3 - 4 - 4,5 - 5 - 6 - 7 - 8 y 10mm.
- Avellanador 36.
- Puntas 25 mm: PH - PZ - SL - T y H3
- Puntas 50 mm: PH y PZ.
- Adaptador de cambio de inserción 1/4" 3/8"
- Portapuntas magnético 60 - 80mm.
- Llaves de vaso.
- Brocas de corona
- Adaptador de brocas de corona 90mm
- Calibre para brocas.
- Llave allen 2,5 mm.
- Topes de profundidad: 3 - 5 - 6 - 8 y 10 mm
- Set de llaves allen (mm)
- Set de llaves allen (pulgadas)
- Metro Makita 3mx13mm.
- Cúter
- Nivel.
- Desatornillador manual
- Llave ajustable
- Lápiz de carpintero 150 mm.
- Punta magnética para tabiquería seca.

Contenido	Unds.	Tipo	Código	EAN	P.V.P. (€)
216 piezas	1	***	E-11689	0088381585019	121,00



Maletines de accesorios



- Puntas 25 mm PH, PZ, T, SL y H.
- Estuche 25 puntas 25 mm PZ2.
- Puntas 60 mm PH, PZ y T.
- Portapuntas 60mm 1/4".
- Avellanador 1/4".
- Llave de vaso 1/4 Hex. 6, 8 y 10 mm.
- Brocas madera 3, 4, 5, 6 y 8 mm.
- Brocas widia 6, 7 y 8 mm.
- Brocas pala 12 y 16 mm.
- Brocas corona Bi-metal 32 y 38 mm.
- Adaptador corona.
- Brocas HSS 2, 3, 4, 5 y 8 mm.

Contenido	Unds.	Código	EAN	P.V.P. (€)
100 piezas	1	B-54520	0088381477802	57,00

- Puntas de 25mm. PZ0(1ud), PZ1(2ud), PZ2(6ud), PZ3(2ud), PH1(1ud), PH2(1ud), PH3(1ud), T15(1ud), T20(1ud), HEX3(1ud), HEX4(1ud), HEX5(1ud), HEX6(1ud), SL0,5x3(1ud), SL0,8x4(3ud), SL0,8x5(1ud), SL1x5,5(2ud), SL1x6(1ud), SL1,2x6,5(2ud), SL1,2x7(1ud).
- Portapuntas magnético 1/4"Hex, 30mm.
- Punta magnética para pladur, 30mm.
- Avellanador 36mm.
- Llaves de vaso 1/4"Hex 38mm. 5, 6, 7, 8, 9, 10, 11, 13mm de diámetro.
- 6 Brocas para madera. 3x60, 4x75, 5x85, 6x92, 7x100, 8x114mm.
- 7 brocas para metal HSS-TIN. 2x49, 3x61(2ud), 3,2x65, 4x75, 4,5x80, 5x86mm.
- 5 brocas para mampostería. 5x85, 5,5x85, 6x100, 7x100, 8x120mm.

Contenido	Unds.	Código	EAN	P.V.P. (€)
60 piezas	1	E-11829	0088381587525	29,00

Maletines de accesorios Maccess

MACCESS

- Estuche 34 piezas:
- Brocas de metal HSS-R.
- Llaves de vaso.
- Portapuntas magnético
- Brocas para mampostería.
- Avellanador.
- Brocas para madera.
- Puntas de varias medidas.

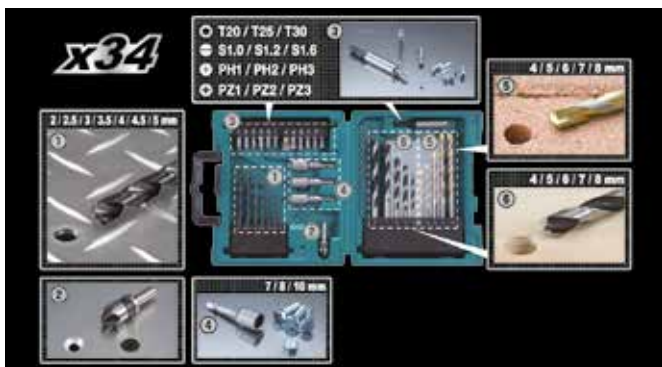

Contenido	Unds.	Código	EAN	P.V.P. (€)
34 piezas	1	D-36980	0088381374248	29,00



- Estuche 71 piezas:
- Brocas de metal HSS-Tin.
- Brocas para mampostería.
- Brocas para madera.
- Brocas de pala.
- Avellanador.
- Cinta métrica (3M).
- Cuchilla.
- Portapuntas magnético.
- Llaves de vaso
- Destornillador.
- Puntas de varias medidas.

Contenido	Unds.	Código	EAN	P.V.P. (€)
71 piezas	1	D-33691	0088381360586	73,00

Maletines de accesorios Maccess



- Estuche 104 piezas:
- Brocas de metal HSS-Tin.
- Brocas para mampostería.
- Brocas para madera.
- Brocas de pala.
- Avellanador.
- Metro (3 m).
- Cúter.
- Portapuntas magnético.
- Llaves de vaso.
- Destornillador.
- Topes de profundidad.
- Nivel.
- Puntas de varias medidas.



Contenido	Unds.	Código	EAN	P.V.P. (€)
104 piezas	1	D-31778	0088381358590	95,00

x104

1 + 7 = 8 pcs.

1.5 / 2 / 2.5 / 3 / 3.5 / 4 / 4.5 / 5 / 5.5 / 6 / 6.5 / 7 / 8 / 10 mm

8 / 15 / 20 mm

3 / 4 / 5 / 6 / 7 / 8 / 10 mm

3 / 4 / 5 / 6 / 8 mm

3 / 4 / 5 / 6 / 7 / 8 / 10 mm

S1 S1.2 S1.1 S1.8 H3 H4 H5 H6

P21 P21 P22 P22 P22 P23 P23 P24 P24

T20 T20 T20 T25 T25 T25 T30 T30 T40 T40

T40 T30 T25 T20 P24 P23 P22 PH4 PH3 PH2

PH1 PH1 PH2 PH2 PH2 PH3 PH3 PH4 PH4

H3 H4 H5 H6 S1 S1 S1.2 S1.2 S1.4

8 10 12 13



Estuches de accesorios Maccess



- Estuche 200 piezas:
- Brocas de metal HSS-Tin.
- Brocas para mampostería.
- Brocas para madera.
- Brocas de pala.
- Avellanador.
- Cinta métrica (5m).
- Cuchilla.
- Portapuntas magnético.
- Llaves de vaso.
- Destornillador.
- Topes de profundidad.
- Nivel.
- Extensores de atornillado.
- Llave inglesa.
- Brocas de corona.
- Alicata de punta.
- Alicata cortador.
- Linterna.
- Puntas de varias medidas.

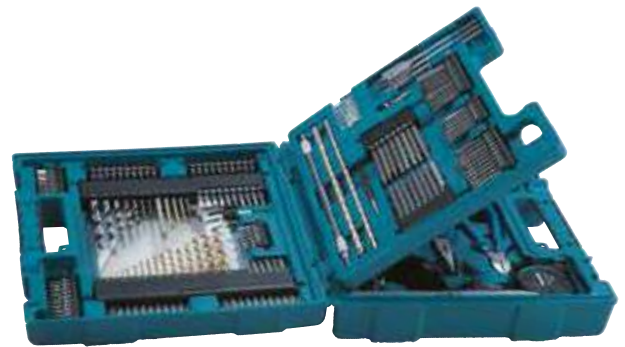

Contenido	Unds.	Código	EAN	P.V.P. (€)
200 piezas	1	D-37194	0088381375399	163,00

X200

300 mm

3/5/8/10 mm

M6

LED

6/5.5/6/7/8/9/10/11/12/13 mm

90°

8/15/20 mm

No incluida

3/4/5/6/8 mm
8x300/10x300 mm

3/4/5/6/7/8/10 mm

1/1.5/2/2.5/3/3.2/3.5/4/4.5/5/5.5/6/6.5/7/8/10 mm

5/6/7/8/9/10/11/13 mm

32/38/45/54/68 mm

1 1/4" 1 1/2" 1 3/4" 2" 2 1/4" 2 1/2" 2 3/4" 3" 3 1/2" 4" 4 1/2" 5" 5 1/2" 6" 6 1/2" 7" 8" 9" 10" 11" 12" 13" 14" 15" 16" 18" 20" 22" 24" 26" 28" 30" 32" 34" 36" 38" 40" 42" 44" 46" 48" 50" 52" 54" 56" 58" 60" 62" 64" 66" 68" 70" 72" 74" 76" 78" 80" 82" 84" 86" 88" 90" 92" 94" 96" 98" 100"

1 1/4" 1 1/2" 1 3/4" 2" 2 1/4" 2 1/2" 2 3/4" 3" 3 1/2" 4" 4 1/2" 5" 5 1/2" 6" 6 1/2" 7" 8" 9" 10" 11" 12" 13" 14" 15" 16" 18" 20" 22" 24" 26" 28" 30" 32" 34" 36" 38" 40" 42" 44" 46" 48" 50" 52" 54" 56" 58" 60" 62" 64" 66" 68" 70" 72" 74" 76" 78" 80" 82" 84" 86" 88" 90" 92" 94" 96" 98" 100"

1 1/4" 1 1/2" 1 3/4" 2" 2 1/4" 2 1/2" 2 3/4" 3" 3 1/2" 4" 4 1/2" 5" 5 1/2" 6" 6 1/2" 7" 8" 9" 10" 11" 12" 13" 14" 15" 16" 18" 20" 22" 24" 26" 28" 30" 32" 34" 36" 38" 40" 42" 44" 46" 48" 50" 52" 54" 56" 58" 60" 62" 64" 66" 68" 70" 72" 74" 76" 78" 80" 82" 84" 86" 88" 90" 92" 94" 96" 98" 100"

1 1/4" 1 1/2" 1 3/4" 2" 2 1/4" 2 1/2" 2 3/4" 3" 3 1/2" 4" 4 1/2" 5" 5 1/2" 6" 6 1/2" 7" 8" 9" 10" 11" 12" 13" 14" 15" 16" 18" 20" 22" 24" 26" 28" 30" 32" 34" 36" 38" 40" 42" 44" 46" 48" 50" 52" 54" 56" 58" 60" 62" 64" 66" 68" 70" 72" 74" 76" 78" 80" 82" 84" 86" 88" 90" 92" 94" 96" 98" 100"



Estuches de accesorios Makpac

**Set de accesorios Makpac B-69478:
Makpac tipo 1.**

- Brocas SDS-PLUS para metal HSS-TIN:
 - 3x 90, 3.5x 100, 4x 105, 4.5x 110, 5x 116, 5.5x 123, 6x 123, 6.5x 131 mm.
- Brocas SDS-PLUS:
 - 6x 160, 7x 160, 8x 160, 10x 160, 12x 160 mm.
- Brocas para madera:
 - 4x 105, 5x 116, 6x 123, 8x 147, 10x 163, 12x 160 mm.
- Puntas:
 - 2x PH0, 2x PH1, 3x PH, 3x PH3.
 - 2x PZ0, 2x PZ1, 2x PZ3, 2x PZ3.
 - 2x SL4, 2x SL5, 2x SL5.5, 2xSL6.5.
 - H3, H4, H5, H6
 - T10, T15, 2xT20, 2x T25, T30, T40.
- Llaves de vaso:
 - 8, 10, 12, 13 mm.
- Avellanador.
- Portapuntas 80 mm SDS-PLUS.
- Cinta métrica 3M.



★★★★

Contenido	Unds.	Código	EAN	P.V.P. (€)
65 piezas	1	B-69478	0088381548731	118,00

**Set de accesorios Makpac B-49638:
Makpac tipo 1.**

- Estuche de puntas 25 mm.
 - Portapuntas 60 mm
 - PH0, PH1, 2x PH2, PH3.
 - PZ0, PZ1, 2x PZ2, PZ3.
 - SL4, SL4.5, SL5.5, SL6.5.
 - T10, 2x T15, 2xT20, 2x T25, T27, 2x T30, T40.
 - T10H, T15H, T25H, T27H, T30H, T40H.
 - H3, H4, H5, H6.
- Pack de puntas PH2/PZ2 50 mm:
 - 5x PH2.
 - 5x PZ2.
- Portapuntas magnético 1/4 Hex tipo "click".
- Llaves de vaso: 6/8/10/12/13 mm.
- Brocas de pala: 16/20 mm.
- Brocas de madera: 3/4/5/6/8 mm.
- Brocas de metal HSS-G: 3/4/5/6/8 mm.
- Brocas mampostería HM: 5/6/8/10 mm.
- Bandeja para colocación de accesorios.



★★★★

Contenido	Unds.	Código	EAN	P.V.P. (€)
69 piezas	1	B-49638	0088381459631	118,00

**Set de accesorios Makpac B-49725:
Makpac tipo 1.**

- 2 Estuches puntas 25 mm.
 - Portapuntas 60 mm:
 - PH0, PH1, 2x PH2 y PH3.
 - PZ0, PZ1, 2x PZ2 y PZ3.
 - SL4, SL4.5, SL5.5 y SL6.5.
 - H3, H4, H5 y H6.
 - T10, 2x T15, 2x T20, 2x T25, T27, 2x T30 y T40.
 - T10H, T15H, T25H, T27H, T30H y T40H.
 - Mango portapuntas.
- Estuche brocas D-46202.
 - Brocas metal HSS-G: 3/4/5/6/8/10 mm.
 - Brocas madera: 3/4/5/6/8/10 mm.
 - Brocas mampostería HMCT: 3/4/5/6/8/10 mm.
- Cintra métrica.
- Cutter (con recambios de hoja).
- Destornillador de carraca.



★★★★

Contenido	Unds.	Código	EAN	P.V.P. (€)
96 piezas	1	B-49725	0088381460965	149,00

**Set de accesorios Makpac B-49884:
Makpac tipo 1.**

- Estuche brocas D-46202.
 - Brocas metal HSS-G: 3/4/5/6/8/10 mm.
 - Brocas madera: 3/4/5/6/8/10 mm.
 - Brocas mampostería HMCT: 3/4/5/6/8/10 mm.
- Estuche de brocas, puntas y vasos.
 - Brocas metal HSS-G: 3/4/5/6/8/10 mm.
 - Puntas 25 mm:
 - 2x PH1, 2x PH2 y PH3.
 - 2x PZ1, 2x PZ2 y PZ3.
 - T10, 2x T15, 2x T20, 2xT25, 2x T30 y T40.
 - SL4.5, 2x SL5.5 y 2x SL6.5.
 - H2, H2.5, H3, H4, 2x H5 y 2x H6.
 - Llaves de vaso 1/4 Hex: 4/5/6/8/10 mm.
 - Portapuntas magnético 1/4 Hex tipo "click".
- Estuche puntas y llaves de vaso:
 - Puntas 25 mm:
 - 2x PH1, 2x PH2 y PH3.
 - 2x PZ1, 2x PZ2 y PZ3.
 - T10, 2x T15, 2x T20, 2xT25, 2x T30 y T40.
 - 2x SL4.5, 2x SL5.5 y 2x SL6.5.
 - H2, H2.5, H3, H4, 2x H5 y 2x H6.
 - Llaves de vaso 1/4 Hex: 4/5/6/8/10 mm.
 - Portapuntas magnético 1/4 Hex tipo "click".
 - Destornillador de carraca.
- Cintra métrica 3 m.
- Cutter (con recambios de hoja).
- Linterna LED (sin pila).

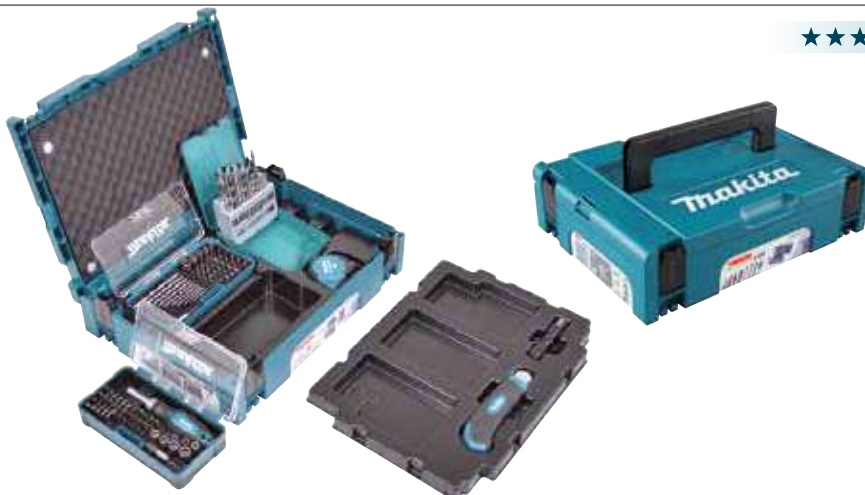











★★★★

Contenido	Unds.	Código	EAN	P.V.P. (€)
116 piezas	1	B-49884	0088381462037	159,00



Brocas de corona

Aplicación	Aluminio 	Acero inoxidable 	PVC 	Acero 	Metales no ferrosos 	Madera 	Epoxy 
✓ Recomendado • Válido							
<i>Ezychange</i> 	✓	•	•	✓	✓	•	
BIM 	•		✓	✓	•	✓	
TCT 	•	✓	✓	✓	•		✓
Consejos	Usar aceite de corte	Bajas Rpm usar con aceite de corte		Usar aceite de corte	Usar aceite de corte		

Brocas de corona Bi-Metálicas



Aplicación:
Para acero, hierro, metal, madera o plásticos.

Ø (mm)	Largo (mm)	Largo útil (mm)	Unds.	Código	EAN	P.V.P. (€)
14	50	38	1	D-35368	0088381369015	3,60
16	50	38	1	D-16994	0088381194792	3,70
17	50	38	1	D-35374	0088381369022	4,30
19	50	38	1	D-17005	0088381194808	4,20
20	50	38	1	D-17251	0088381195805	4,50
21	50	38	1	D-35380	0088381369039	4,80
22	50	38	1	D-17011	0088381194815	4,80
24	50	38	1	D-17027	0088381194822	5,50
25	50	38	1	D-17033	0088381194839	5,50
27	50	38	1	D-35396	0088381369046	5,50
29	50	38	1	D-17267	0088381195812	5,50
30	50	38	1	D-35405	0088381369053	5,70
32	44	38	1	D-17049	0088381194853	5,80
33	44	38	1	D-35411	0088381369060	6,00
35	44	38	1	D-17055	0088381194860	6,40
37	44	38	1	D-35427	0088381369077	6,40
38	44	38	1	D-17061	0088381194877	6,40
40	44	38	1	D-17273	0088381195829	6,70
41	44	38	1	D-35433	0088381369084	7,00
43	44	38	1	D-35449	0088381369091	7,30
44	44	38	1	D-17077	0088381194884	7,30
46	44	38	1	D-35455	0088381369107	7,90
48	44	38	1	D-35461	0088381369114	8,20
51	44	38	1	D-17083	0088381194891	8,50
52	44	38	1	D-35477	0088381369121	8,20
54	44	38	1	D-24876	0088381334778	8,20

Ø (mm)	Largo (mm)	Largo útil (mm)	Unds.	Código	EAN	P.V.P. (€)
56	44	38	1	D-35483	0088381369138	8,90
57	44	38	1	D-17099	0088381194907	8,90
59	44	38	1	D-35499	0088381369145	8,90
60	44	38	1	D-25688	0088381338516	8,90
64	44	38	1	D-30140	0088381351263	9,50
65	44	38	1	D-24882	0088381334785	9,50
67	44	38	1	D-35508	0088381369152	10,20
68	44	38	1	D-17108	0088381194914	10,20
70	44	38	1	D-25694	0088381338523	10,90
73	44	38	1	D-35514	0088381369169	11,20
76	44	38	1	D-17114	0088381194921	11,50
79	44	38	1	D-35520	0088381369176	11,50
83	44	38	1	D-17120	0088381194938	11,80
86	44	38	1	D-35536	0088381369183	11,80
89	44	38	1	D-35542	0088381369190	12,70
92	44	38	1	D-17136	0088381194945	12,70
95	44	38	1	D-35558	0088381369206	13,00
98	44	38	1	D-35564	0088381369213	13,30
102	44	38	1	D-35570	0088381369220	14,10
105	44	38	1	D-17142	0088381194952	14,60
108	44	38	1	D-35586	0088381369237	16,10
111	44	38	1	D-35592	0088381369244	16,60
114	44	38	1	D-35601	0088381369251	17,30
121	44	38	1	D-35617	0088381369268	17,90
127	44	38	1	D-17158	0088381194969	18,50
140	44	38	1	D-35623	0088381369275	20,00
152	44	38	1	D-17164	0088381194983	22,00

Brocas de corona

Adaptador con broca de centrado para coronas Bi-Metálicas



Ø (mm)	Tipo	Unds.	Código	EAN	P.V.P. (€)
14-29	10 Hex	1	D-17170	0088381194976	4,30
32-152	13 Hex	1	D-17186	0088381195003	7,90
14-29	SDS-PLUS	1	D-17603	0088381196727	6,40
32-76	SDS-PLUS	1	D-17619	0088381196734	10,40

Broca de centrado para coronas Bi-Metálicas



Ø (mm)	Longitud (mm)	Unds.	Código	EAN	P.V.P. (€)
6	71	1	D-17192	0088381194990	3,20



Estuches de brocas de corona Bi-Metálicas



D-47298

D-47117

Ø (mm)	Uso	Unds.	Código	EAN	P.V.P. (€)
19, 22, 25, 29, 35, 44, 51, 57, 68 y 75	Fontanería	1	D-47298	0088381424370	109,00
19, 22, 29, 38, 44 y 57	Fontanería	1	D-47117	0088381423731	48,00



D-47123

Ø (mm)	Uso	Unds.	Código	EAN	P.V.P. (€)
16, 20, 25, 32, 40 y 51	Electricidad	1	D-47123	0088381423748	41,00
20, 25, 32, 40, 51 y 65	Electricidad	1	D-47139	0088381423755	48,00

Nuevo



Ø (mm)	Unds.	Código	EAN	P.V.P. (€)
22, 29, 35, 44, 57, 64, 76, 92, 111, 127mm Inserción de 9,5 y 11mm. Adaptador y broca de centrado.	1	D-75764	0088381597692	140,00



Brocas de corona Ezychange



Brocas Bi-metálicas con cobalto válidas para: madera, metal, aluminio, acero inoxidable y plástico.



ALTA CALIDAD con un 8% de COBALTO PARA UNA MAYOR DURACIÓN

Ø (mm)	Largo (mm)	Largo útil (mm)	Unds.	Código	EAN	P.V.P. (€)
16	-	44	1	E-03632	0088381561877	8,60
17	46	40	1	B-31706	0088381419161	8,60
19	46	40	1	E-03654	0088381561891	8,60
20	46	40	1	E-03660	0088381561907	8,60
22	46	40	1	E-03676	0088381561914	9,10
25	46	40	1	E-03698	0088381561938	11,00
27	46	40	1	E-03707	0088381561945	10,50
29	46	40	1	E-03713	0088381561952	10,50
32	46	40	1	E-03735	0088381561976	10,90
37	46	40	1	E-03757	0088381561990	11,60
38	46	40	1	E-03763	0088381562003	11,00
40	46	40	1	E-03779	0088381562010	12,10
41	46	40	1	E-03785	0088381562027	12,10
44	46	40	1	E-03791	0088381562034	12,70
46	46	40	1	E-03800	0088381562041	12,70
51	46	40	1	E-03822	0088381562065	13,20
52	46	40	1	E-03838	0088381562072	14,10
56	46	40	1	E-03850	0088381562096	15,10

Ø (mm)	Largo (mm)	Largo útil (mm)	Unds.	Código	EAN	P.V.P. (€)
57	46	40	1	E-03866	0088381562102	15,10
60	46	40	1	E-03872	0088381562119	15,10
65	46	40	1	E-03894	0088381562133	16,10
67	46	40	1	E-14152	0083381592437	22,00
68	46	40	1	E-03903	0088381562140	17,10
73	46	40	1	E-03925	0088381562164	17,30
76	46	40	1	E-03931	0088381562171	17,30
79	46	40	1	E-03947	0088381562188	20,00
83	46	40	1	E-03953	0088381562195	20,00
86	46	40	1	E-03969	0088381562201	21,00
89	46	40	1	E-14168	0083381592444	25,00
95	46	40	1	E-03981	0088381562225	27,00
105	46	40	1	E-04008	0088381562249	27,00
111	46	40	1	E-04014	0088381562256	34,00
114	46	40	1	E-04020	0088381562263	34,00
121	46	40	1	E-04036	0088381562270	39,00
127	46	40	1	E-04042	0088381562287	34,00
133	46	40	1	E-14174	0088381592451	56,00
140	46	40	1	E-04058	0088381562294	44,00
152	46	40	1	E-04064	0088381562300	45,00

Adaptadores para coronas Ezychange

Broca de centrado



Longitud	Contenido	Unds.	Código	EAN	P.V.P. (€)
70 mm	Cilíndrico con broca de centrado	1	E-04070	0088381562317	26,00

Tipo	Unds.	Código	EAN	P.V.P. (€)
HSS	1	E-04086	0088381562324	6,90

Estuches de brocas de corona Ezychange



E-12304
E-12310
E-12326

E-14261

Ø (mm)	Unds.	Código	EAN	P.V.P. (€)
19,22,29,38,44,57	6	E-12304	0088381585668	163,00
16,20,25,32,40,51	6	E-12310	0088381585675	150,00
20,25,32,40,51,65	6	E-12326	0088381585682	163,00
22,25,32,44,51,68, adaptador y broca de centrado	8	E-14261	0088381593632	260,00

Brocas de corona multimaterial Ezychange



E-06644

E-14261

Ø (mm)	Profundidad de corte (mm)	Unds.	Código	EAN	P.V.P. (€)
20	60	1	E-06644	0088381570367	24,00
22	60	1	E-06650	0088381570374	25,00
25	60	1	E-06666	0088381570381	25,00
32	60	1	E-06672	0088381570398	27,00
35	60	1	E-06688	0088381570404	27,00
38	60	1	E-06694	0088381570411	28,00
40	60	1	E-06703	0088381570428	29,00
44	60	1	E-06719	0088381570435	30,00
51	60	1	E-06725	0088381570442	33,00
54	60	1	E-06731	0088381570459	41,00
60	60	1	E-06747	0088381570466	43,00
64	60	1	E-06753	0088381570473	43,00
67	60	1	E-06769	0088381570480	44,00
68	60	1	E-06775	0088381570497	44,00
70	60	1	E-06781	0088381570503	45,00
73	60	1	E-06797	0088381570510	46,00
76	60	1	E-06806	0088381570527	46,00
83	60	1	E-06812	0088381570534	48,00
102	60	1	E-06828	0088381570541	72,00
127	60	1	E-06834	0088381570558	155,00



Adaptadores para coronas Ezychange



Longitud	Contenido	Unds.	Código	EAN	P.V.P. (€)
70 mm	Incluye broca de centrado	1	E-06959	0088381570701	36,00
150 mm	Adaptador	1	E-06878	0088381570596	32,00
300 mm	Adaptador	1	E-06884	0088381570602	35,00



Broca de centrado



Tipo	Unds.	Código	EAN	P.V.P. (€)
HSS-G	1	E-06840	0088381570565	10,70
HSS-CO	1	E-06856	0088381570572	15,00
TCT	1	E-06862	0088381570589	13,90



Brocas de corona HM

★★★★★

Brocas de corona metal duro (alta durabilidad).

Con pastillas de metal duro, preparada para soportar altas temperaturas producidas por cortes profundos y continuos.

Para chapa de acero, acero inox, vigas de hierro (doble t), etc.



* Para taladros superiores a 4mm de espesor se recomienda refrigerar la broca.



Ø (mm)	Inserción (mm)	Tipo	Unds.	Código	EAN	P.V.P. (€)
16	6	HM	1	B-00898	0088381114004	52,00
18	6	HM	1	B-00907	0088381114011	55,00
20	6	HM	1	B-00913	0088381114028	55,00
21	6	HM	1	B-00929	0088381114035	55,00
22	6	HM	1	B-00935	0088381114042	55,00
25	10	HM	1	B-00941	0088381114059	55,00
27	10	HM	1	B-00957	0088381114066	56,00
30	10	HM	1	B-00979	0088381114080	58,00
32	10	HM	1	B-00985	0088381114097	67,00
35	10	HM	1	B-00991	0088381114103	67,00
38	10	HM	1	B-01002	0088381114110	79,00
40	10	HM	1	B-01018	0088381114127	80,00
45	10	HM	1	B-01024	0088381114134	88,00
48	10	HM	1	B-01030	0088381114141	97,00
50	10	HM	1	B-01046	0088381114158	101,00
60	13	HM	1	B-01068	0088381114172	143,00
90	13	HM	1	B-01127	0088381114288	253,00

Brocas de centrado para brocas HM



Ø (mm)	Tipo	Uso	Unds.	Código	EAN	P.V.P. (€)
6	HSS	Acero	1	B-01177	0088381114233	10,50
8	HSS	Acero	1	B-01183	0088381114240	11,00
6	HM	Resina, FRP...	1	B-01199	0088381114301	12,70
8	HM	Resina, FRP...	1	B-01208	0088381114318	15,40

Batidores

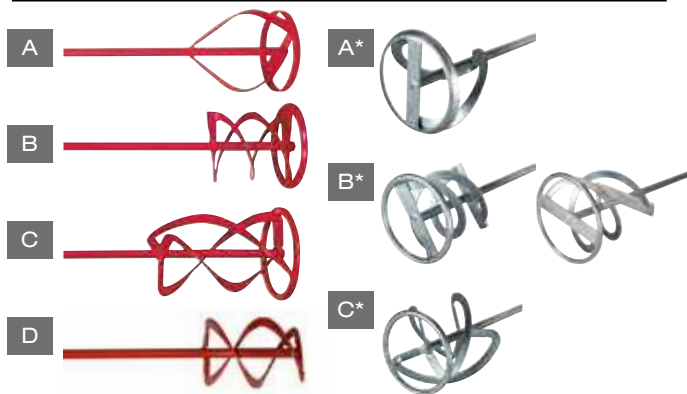

A	Para pinturas, lacas, yeso, revestimientos finos, etc.
B y D	Todos los materiales viscosos, conveniente para todos los tipos de mortero, yeso, resinas de epoxi llenadas por cuarzo, etc.
C	Para todos los materiales pegajosos y viscosos, por ejemplo pegamentos de azulejo, morteros, yesos, rellenos, etc.

Inser.	Ø (mm)	Long. (mm)	Tipo	Modelos	Unds.	Código	EAN	P.V.P. (€)	
8	80	400	A	DA6301 DS4010	1	P-02331	0088381918527	15,40	
10	90	400	D		1	P-02347	0088381918534	14,90	
8	100	590	C	UT1200 UT1400 UT1401 UT1600	1	P-02353	0088381918541	34,00	
M14	90	590	D		1	P-22028	0088381949088	27,00	
M14	120	590	A		1	P-22012	0088381949071	26,00	
M14	140	590	B		1	P-22040	0088381949101	33,00	
M14	120	590	C		1	P-22056	0088381949118	39,00	
M14	120	600	A*		1	D-73508	0088381584869	17,30	
M14	120	600	B*		1	D-73514	0088381584876	18,60	
M14	120	600	C*		1	D-73520	0088381584883	18,60	
3/8" hex					DA6301 DS4010		D-73536	0088381584890	11,80
10	120	600	B*			1	D-73542	0088381584906	11,10

Adaptadores para batidores



Modo de empleo: Para utilizar batidor de inserción M14 en un taladro, es necesario desmontar el portabrocas, en su lugar colocar el adaptador y en el otro extremo insertar el batidor que más convenga para el tipo de trabajo.

Ø (mm)	Inserción	Modelo	Unds.	Código	EAN	P.V.P. (€)
1/2"	M14	6013B/ DP4002	1	P-22062	0088381949125	11,00
5/8"	M14	DA6301	1	P-02325	0088381918510	11,00

Disco mezclador (sin varilla A-43751)



Ø (mm)	Inserción	Modelo	Unds.	Código	EAN	P.V.P. (€)
165 mm	M8	DUT130	1	A-43692	0088381198707	14,40

Varilla para mezclador inox. A-43692



Ø (mm)	Inserción	Modelo	Unds.	Código	EAN	P.V.P. (€)
1/2"	M14	6013B/ DP4002	1	168349-5	0088381160261	26,00

★★★★★
★★★★★
★★★★★
★★★★★

★★★★★



Extensión DA4000LR



DA4000LR con extensión.

Modelos	Longitud (mm)	Unds.	Código	EAN	P.V.P. (€)
DA4000LR	760	1	193317-9	0088381160971	251,00

Topes de profundidad



Modelos	Unds.	Código	EAN	P.V.P. (€)
DP2010 DP2011	1	322177-4	0088381126441	1,20
HP1620/1 HP2033 HP2050/1 HP2070/1	1	415486-9	0088381147033	0,95
DP4011	1	324219-0	0088381171458	2,00



Soporte de taladro y accesorios

Soporte de taladro

[a]



*Eurocuello 43 mm.

Unds.	Código	EAN	P.V.P. (€)
1	A-36706*	0088381183130	396,00

Soporte de tope horizontal

[b]



Unds.	Código	EAN	P.V.P. (€)
1	501329	-	36,00

Mordaza horizontal

[c]

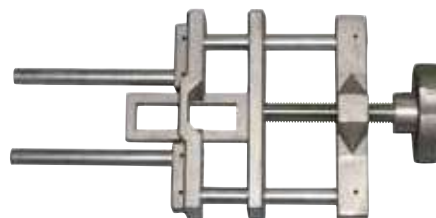

Unds.	Código	EAN	P.V.P. (€)
1	132126-1	-	169,00



Soporte de guía y accesorios

Soporte de guía

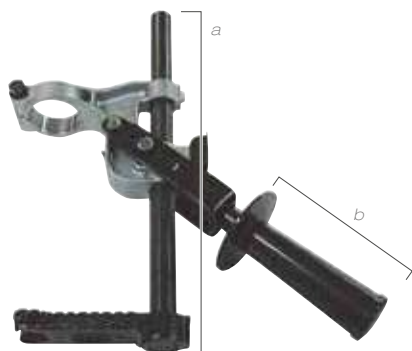

1

Despiece	Unds.	Código	EAN	P.V.P. (€)
[a] Garra: 134279-2	1	501353	-	173,00
[b] Empuñadura: 273466-9				
Kit soporte guía taladro	1	134279-2	-	150,00

Kit de soporte (base + palanca)



2

Kit completo
(máquina no incluida)

Despiece	Unds.	Código	EAN	P.V.P. (€)
[1+2] Kit completo	1	501043	-	198,00
[a] Palanca: 155696-3	1	501035	-	27,00
[b] Tornillo: 924306-1				
[c] Tornillos (2Unds.): 912317-8				
[d] Base: 342802-1				

Base en "V"

Para utilizar con SOPORTE GUÍA 501353



Despiece	Unds.	Código	EAN	P.V.P. (€)
[a] Base en V: 163221-6	1	501036	-	11,00
[b] Tornillo: 911321-4				

Tope de ajuste

Para utilizar con SOPORTE GUÍA 501353



Despiece	Unds.	Código	EAN	P.V.P. (€)
[a] Arandela: 941101-4	1	501037	-	4,70
[b] Tornillo: 251259-4				
[c] Tope: 342804-7				

Alargador de base













Para utilizar con SOPORTE GUÍA 501353



Despiece	Unds.	Código	EAN	P.V.P. (€)
[a] Tornillo (2Unds.): 911321-4	1	501038	-	5,00
[b] Suplemento: 342818-6				















Portabrocas automático

Tipo	Imagen	Modelos	Capacidad (mm)	Paso	Cierre / llave	Unds.	Código	EAN	P.V.P. (€)
Automático		HP1631 6310 HP1641	1,5 - 13	1/2" - 20	Lock	1	P-15718	0088381932202	39,00
		HP2051 HP2071 DP4011	1,5 - 13	1/2" - 20	Carraca	1	194254-0	0088381206907	51,00
		6317D 6337D 6347D	1,5 - 13	1/2" - 20	Estándar	1	766010-4	-	31,00
		DP3003	1,0 - 10	1/2" - 20	Lock	1	193226-2	0088381150347	35,00
		6501X DP2011	0,8 - 6,5	3/8" - 24	Estándar	1	193203-4	0088381157285	36,00
		6413	1,0 - 10	3/8" - 24	Estándar	1	763180-0	0088381189156	10,00
		DF331D	1,0 - 10	3/8" - 24	-	1	763228-8	-	12,40
		HP331D	1,0 - 10	3/8" - 24	-	1	763229-6	-	10,10
		6261D 6271D 6281D	0,8 - 10	3/8" - 24	-	1	766002-3	0088381350549	10,50
		DF330D	0,8 - 10	3/8" - 24	-	1	766007-3	0088381354219	11,60
		8270D 8280D	0,8 - 10	1/2" - 20	-	1	763187-6	0088381196192	15,40
		6260D 6270D 6280D	0,8 - 10	1/2" - 20	-	1	763185-0	0088381192873	11,30
		8391D	0,8 - 10	1/2" - 20	-	1	766004-9	0088381359825	15,00
		DDF458 DF001G DHP458 DHP486 HP001G	1,5 - 13	1/2" - 20	-	1	763252-1	0088381584920	26,00



Portabrocas manual

Tipo	Imagen	Modelos	Capacidad (mm)	Paso	Cierre / llave	Unds.	Código	EAN	P.V.P. (€)
Manual		6501 DP2010	0,5 - 6,5	3/8" - 24	763435-3	1	763077-3	0088381114837	5,60
		6413 6408 DA3011F	1,0 - 10	3/8" - 24	-	1	P-11835*	-	13,20
		HP1620	1,5 -13,0	1/2" - 20	763440-0	1	196008-1*	0088381433792	12,10
		HP1640	1,5 -13,0	1/2" - 20	763448-4	1	766016-2	-	9,60
		HP2050 HP2070 DS4012	1,5 -13,0	1/2" - 20	763430-3	1	193822-6*	0088381184250	28,00
		HP2010N 6300-4 6013B	1,5 -13,0	1/2" - 20	763432-9	1	192877-8	0088381147934	37,00
		DP4000 DP4002	1,5 -13,0	1/2" - 20	763434-5	1	193228-8	0088381158183	40,00
		DP3002	1,0 - 10,0	1/2" - 20	763434-5	1	193224-6	0088381158176	43,00
		DA4031	2,0 - 13,0	***	763432-9	1	193519-7	0088381164597	55,00
		DA6301	1,5 - 13,0	5/8" - 16	763432-9	1	763062-6	0088381102223	45,00
		DA4000LR	2,0 - 13,0	***	763432-9	1	193318-7	0088381160957	51,00
		DA3010F	1,0 - 10,0	**	763415-9	1	763174-5	0088381181945	41,00
		MT603	1,0 - 10,0			1	193706-8	0088381193078	7,20





Atornillado

IMPACT BLACK



Impact
PREMIER



Tabla de contenido



Puntas 25mm



Puntas 50mm

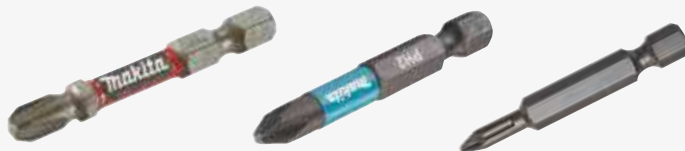

Puntas dobles



Portapuntas



Llaves de vaso



Estuches de puntas



Adaptadores cambio de inserción



Vasos y estuches de vasos



Otros



Impact PREMIER



Presentamos nuestra mejor gama de puntas, portapuntas y llaves de vaso **IMPACT PREMIER**, una gama rediseñada que eleva la dureza y mejora la calidad y durabilidad de nuestros accesorios.

- La nueva forma de torsión hace que esta gama sea perfecta para trabajos con atornilladores de impacto.
- Ofrecen un gran ajuste de la punta en el tornillo.
- Cada tipo de punta está diferenciada por un color para el reconocimiento sencillo de cada una.



Impact PREMIER



Mayor precisión de encaje.

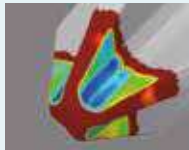

Con un tornillo cerca

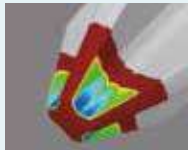

Con un tornillo a distancia



Impact
PREMIER



Estándar

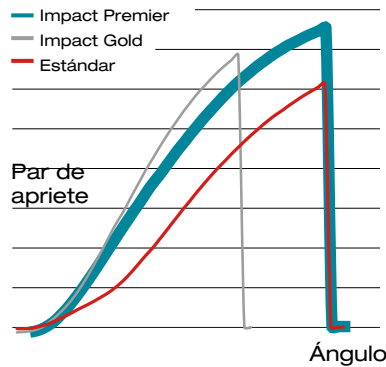

Doble torsión que consigue mayor durabilidad.



Puntas Impact Premier



• Nuevo código de color:
Cada tipo de punta tiene un color asociado.

★★★★★



Punta	Tipo	Longitud (mm)	Unds.	Código	EAN	P.V.P. (€)
PH ⊕	PH1	25	2	E-03121	0088381569798	3,30
	PH2	25	2	E-03137	0088381569804	3,30
	PH3	25	2	E-03159	0088381569828	3,30
	PH1	50	2	E-03268	0088381569934	6,60
	PH2	50	2	E-03274	0088381569941	6,60
	PH3	50	2	E-03280	0088381570244	6,60
PZ ⊕	PZ1	25	2	E-03165	0088381569835	3,30
	PZ2	25	2	E-03171	0088381569842	3,30
	PZ3	25	2	E-03187	0088381569859	3,30
	PZ1	50	2	E-03296	0088381569958	6,60
	PZ2	50	2	E-03305	0088381569965	6,60
	PZ3	50	2	E-03311	0088381569972	6,60
T ⊕	T10	25	2	E-03193	0088381569866	3,30
	T15	25	2	E-03202	0088381569873	3,30
	T20	25	2	E-03218	0088381569880	3,30
	T25	25	2	E-03224	0088381569897	3,30
	T30	25	2	E-03230	0088381569903	3,30
	T40	25	2	E-12027	0088381585163	5,20
	T10	50	2	E-03327	0088381569989	6,60
	T15	50	2	E-03333	0088381569996	6,60
	T20	50	2	E-03349	0088381570008	6,60
	T25	50	2	E-03355	0088381570015	6,60
T30	50	2	E-03361	0088381570022	6,60	

MagBoost

★★★★★



Mag Boost: portapuntas magnético 25mm.

- Proporciona un imantado extra para una fijación fuerte del tornillo.
- A diferencia del Ultramag, el Mag Boost no es un portapuntas, si no que se acopla a la punta directamente.
- Las puntas han de tener un mínimo de 50mm. Ideal para puntas largas ya sea cual sea la longitud, siempre se puede colocar a pocos milímetros de la cabeza.
- Tiene inserción cilíndrica por lo que también es compatible con atornilladores manuales (6,35mm de diámetro, 1/4" Hex.).



Descripción	Longitud (mm)	Unds.	Código	EAN	P.V.P. (€)
Imán	25	1	E-03442	0088381570107	4,40

Llaves de vaso móviles Impact Premier

★★★★★



Tornillo	Ø (mm)	Largo (mm)	Unds.	Código	EAN	P.V.P. (€)
M8	13	80	1	E-03492	0088381570152	9,40
M10	17	80	1	E-03517	0088381570176	9,90
M12	19	80	1	E-03523	0088381570183	10,20

Llaves de vaso imantadas Impact Premier

★★★★★



Tornillo	Ø (mm)	Largo (mm)	Unds.	Código	EAN	P.V.P. (€)
M3,5	6	65	1	E-03458	0088381570114	6,60
M5	8	65	1	E-03464	0088381570121	6,60
M6	10	65	1	E-03470	0088381570138	6,60
M8	13	65	1	E-03486	0088381570145	6,90

Portapuntas Ultramag Impact Premier

★★★★★



Tipo	Long. (mm)	Inserción	Unds.	Código	EAN	P.V.P. (€)
Imantado Neodimio	79	1/4"	1	E-03414	0088381570077	9,90

Portapuntas torsión Impact Premier

★★★★★



Tipo	Long. (mm)	Inserción	Unds.	Código	EAN	P.V.P. (€)
Imantado	66	1/4"	1	E-03399	0088381570053	8,60
Imantado	150	1/4"	1	E-03408	0088381570060	9,40

Adaptador móvil

★★★★★



E-03420

E-03436

Inserción	Longitud (mm)	Unds.	Código	EAN	P.V.P. (€)
1/4" - 3/8"	56	1	E-03420	0088381570084	6,60
1/4" - 1/2"	56	1	E-03436	0088381570091	6,60

Estuches de puntas Impact Premier

- Portapuntas magnético.
- Puntas de 25mm: PH1x1, PH2x5, PH3x2, PH3x2, PZ1x1, PZ2x5, PZ3x2, T10x1, T15x1, T20x3, T25X2, T30x2, H4x1, H5X1, H6x1, SL4x1, SL6x1.

★★★★★



Contenido	Unds.	Código	EAN	P.V.P. (€)
31 piezas	1	E-13552	0088381591577	40,00

- 5 puntas 50mm de largo: PH2, PZ2 PZ3, T25, T30.

★★★★★



Contenido	Unds.	Código	EAN	P.V.P. (€)
5 piezas	1	E-13568	0088381591584	12,80

- Portapuntas.
- Puntas PH: PH2.
- Puntas PZ: Pz1, 2x Pz2 y Pz3.
- Puntas T: T20, T25 y T30.
- Puntas planas: SL4 y SL6.

★★★★★



Contenido	Unds.	Código	EAN	P.V.P. (€)
11 piezas	1	E-03573	0088381570213	25,00

Puntas dobles Impact Premier

★★★★★



Punta	Tipo	Longitud (mm)	Unds.	Código	EAN	P.V.P. (€)
PH	PH2	65	2	E-06286	0088381570220	9,90
PZ	PZ2	65	2	E-06292	0088381570237	9,90



Puntas para atornillar Impact Black

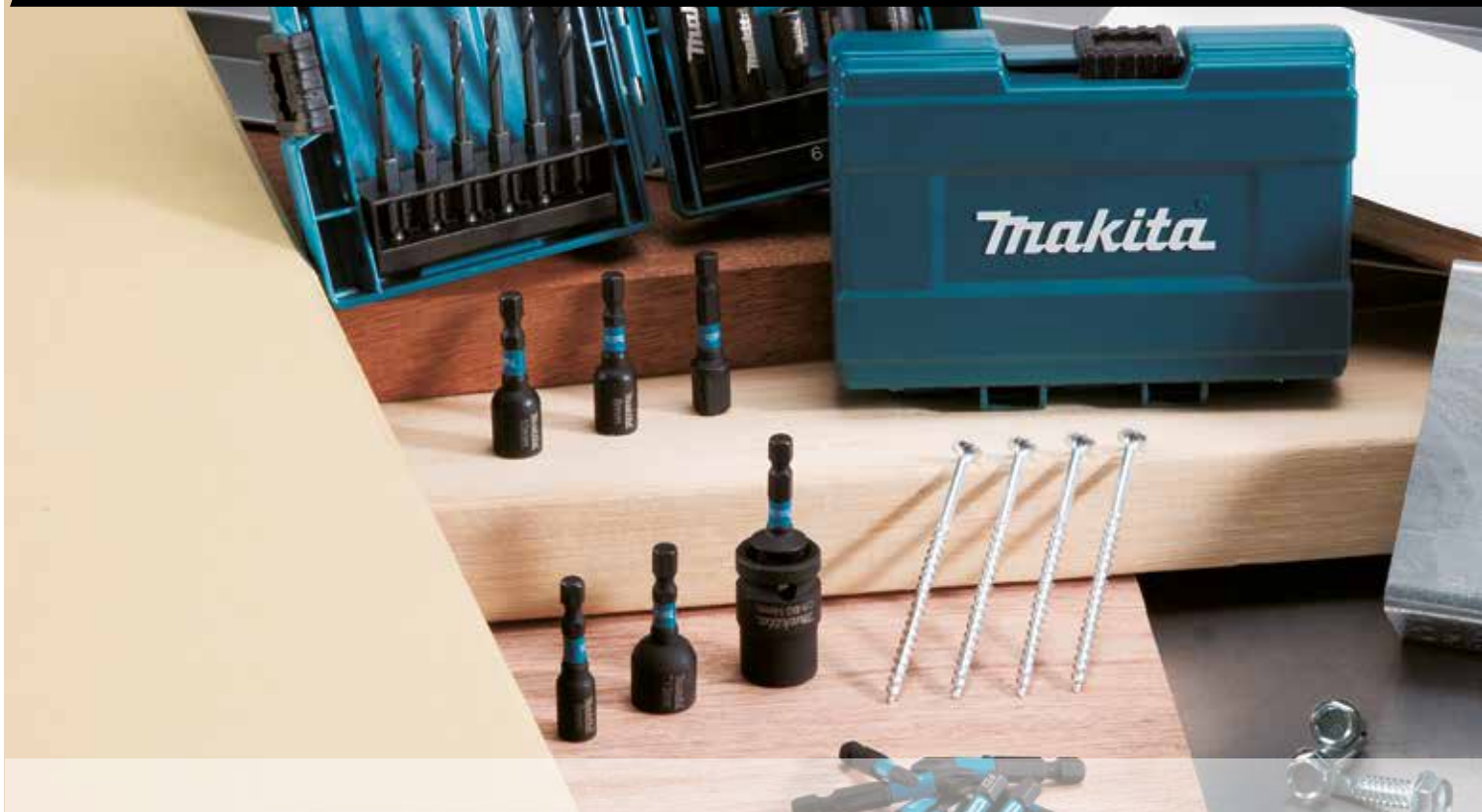

Estuches de puntas y llaves de vaso Impact Black



Punta	Unds.	Código	EAN	P.V.P. (€)
35 Piezas: PH 3xPH2 PH3 x 25mm PH1 2xPH2 PH3 x 50mm PZ1 3xPZ2 PZ3 x 25mm PZ1 2xPZ2 PZ3 x 50mm T 15 2xT20 2xT25 T30 x 25mm T15 T20 2xT25 T30 x 50mm SL5.5 x 50mm Llaves de vaso: 6,8,10,13mm Portapuntas magnético 60mm	1	B-66880	0088381540018	43,00

★★★

Punta	Unds.	Código	EAN	P.V.P. (€)
Llaves de vaso impact black 1/4", 6 pcs 6, 7, 8, 10, 12 y 13 mm	1	E-15768	0088381599818	19,30



★★★

Punta	Unds.	Código	EAN	P.V.P. (€)
10 puntas de 50 mm: PH1, PH2, PH3, PZ1, PZ2, PZ3, T15, T20, T25, T30	1	E-12011	0088381589482	14,90



★★★

Punta	Unds.	Código	EAN	P.V.P. (€)
7 puntas de 25 mm: PH1, PH2, PH3, PZ1, PZ2, PZ3, T15, T20, T25, T30	1	E-11994	0088381589468	8,80

**IMPACT
BLACK**



Expositor de cartón Impact Black (12unds)

★★★



Contenido	Pcs.	Unds.	Código	EAN	P.V.P. (€)
25 puntas: PH2-25mm	25	12	E-12360-12	0088381586573	177,00
25 puntas: PZ2-25mm	25	12	E-12376-12	0088381586597	177,00
10 puntas: PH2-50mm	10	12	E-12407-12	0088381586658	133,00
10 puntas: PZ2-50mm	10	12	E-12413-12	0088381586726	133,00

Expositor de cartón Impact Black (10unds)

★★★

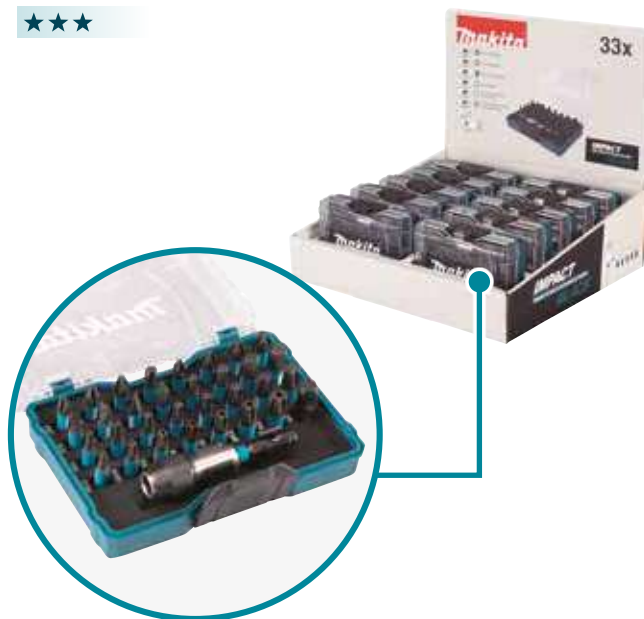

Contenido	Pcs.	Unds.	Código	EAN	P.V.P. (€)
Set de puntas	33	10	E-12441-10	0088381587792	243,00

Guía de atornillado Impact Black



★★★

Descripción	Unds.	Código	EAN	P.V.P. (€)
Guía de atornillado 80 mm	1	B-66818	0088381539944	6,00

Portapuntas magnético Impact Black

★★★



Descripción	Unds.	Código	EAN	P.V.P. (€)
Portapuntas magnético 60 mm	1	B-66793	0088381539920	4,90
	1	B-66802	0088381539937	4,80

Llaves de vaso Impact Black

★★★



Descripción	Medidas (mm)	Unds.	Código	EAN	P.V.P. (€)
Llave vaso magnética	6x50	1	B-66824	0088381539951	3,30
Llave vaso magnética	8x50	1	B-66830	0088381539968	3,40
Llave vaso magnética	10x50	1	B-66846	0088381539975	3,30
Llave vaso magnética	13x50	1	B-66852	0088381539982	3,40



Puntas serie Impact Black

★★★



Cambios de inserción Impact Black

★★★



B-66868

B-66874

Descripción	Unds.	Código	EAN	P.V.P. (€)
Portapuntas magnético 60 mm 1/4" - 3/8"	1	B-66868	0088381539999	2,40
Portapuntas magnético 60 mm 1/4" - 1/2"	1	B-66874	0088381540001	2,95

Descripción	Longitud (mm)	Unds.	Código	EAN	P.V.P. (€)
PH1	25	2	B-63600	0088381532877	1,75
PH2	25	2	B-63616	0088381532884	1,75
PH3	25	2	B-63622	0088381532891	1,75
PH1	50	2	B-63719	0088381532983	2,60
PH2	50	2	B-63725	0088381532990	2,60
PH3	50	2	B-63731	0088381533003	2,60
PZ1	25	2	B-63638	0088381532907	1,75
PZ2	25	2	B-63644	0088381532914	1,75
PZ3	25	2	B-63650	0088381532921	1,75
PZ1	50	2	B-63747	0088381533010	2,60
PZ2	50	2	B-63753	0088381533027	2,60
PZ3	50	2	B-63769	0088381533034	2,60
T15	25	2	B-63666	0088381532938	1,75
T20	25	2	B-63672	0088381532945	1,75
T25	25	2	B-63688	0088381532952	1,75
T30	25	2	B-63694	0088381532969	1,75
T40	25	2	B-63703	0088381532976	1,75
T15	50	2	B-63775	0088381533041	2,60
T20	50	2	B-63781	0088381533058	2,60
T25	50	2	B-63797	0088381533065	2,60
T30	50	2	B-63806	0088381533072	2,60
T40	50	2	B-63812	0088381533089	2,60
PH2	25	25	E-12360	0088381586566	14,60
PH2	50	10	E-12407	0088381586641	10,50
PZ2	25	25	E-12376	0088381586580	14,60
PZ2	50	10	E-12413	0088381586719	10,50
T20	25	25	E-12382	0088381586603	14,60
T25	25	25	E-12398	0088381586627	14,60
T30	25	25	E-12653	0088381588324	14,60
T40	25	25	E-12669	0088381588348	14,60
T20	50	10	E-12429	0088381586665	10,50
T25	50	10	E-12435	0088381586689	10,50
T30	50	10	E-12675	0088381588362	10,50
T40	50	10	E-12681	0088381588386	10,50





Set autoalimentado atornillado



- Convierte tu atornillador de tabiquería seca en uno autoalimentado.
- Para colocación de ristas de tornillo estándar.

Tornillos	Modelos	Código	EAN	P.V.P. (€)
25-55 mm	DFS250 - DFS451 - DFS452 FS2300 FS4000 - FS6300R	191L24-0	0088381566414	102,00



Punta PH2 130mm (5 Unds.) para 199146-8	199155-7	0088381528184	47,00
--	----------	---------------	-------

Puntas para atornilladores autoalimentados



Tipo	Long. (mm)	Modelos	Unds.	Código	EAN	P.V.P. (€)	
PH	PH2	110	6830	1	P-13552	0088381922517	4,00
	PH2	117	DFR440	3	P-66793	0088381997324	13,20
	PH2	127	6832 6833 6835D	1	P-13568	0088381922524	6,30
	PH2	141	6834	1	P-21593	0088381948722	5,00
	PH2	155	DFR551	5	191V02-0	0088381585200	21,00
	PH2	157	6842 DFR550	3	P-67795	0088381998321	17,70
	PH2	177	6844	3	P-67804	0088381998338	21,00
PZ	PZ2	110	6830	1	P-13574	0088381922531	3,90
	PZ2	117	DFR440	3	P-66824	0088381997355	13,20
	PZ2	127	6832 6833 6835D	1	P-13580	0088381922548	6,00
	PZ2	141	6834	1	P-21618	0088381948746	22,00
	PZ2	155	DFR551	5	191V06-2	0088381585224	37,00
	PZ2	157	6842 DFR550	3	P-67773	0088381998307	17,70
	PZ2	177	6844	3	P-67789	0088381998314	21,00

Punta magnética para tabiquería seca ★★★



Tipo	Longitud (mm)	Unds.	Código	EAN	P.V.P. (€)	
PH	PH2	30	1	D-61690	0088381477949	2,10

Puntas ★★★★★



- Puntas de gran durabilidad para aplicaciones profesionales e industriales.

Tipo	Longitud (mm)	Unds.	Código	EAN	P.V.P. (€)	
PH	PH1	25	10	P-06030	0088381946773	8,80
	PH2	25	10	P-06052	0088381946797	8,80
	PH3	25	10	P-06074	0088381946810	8,80
	PH2	25	3	798312-0	0088381107846	2,20
	PH1	50	10	P-06046	0088381946780	26,00
	PH2	50	10	P-06068	0088381946803	25,00
PZ	PH3	50	10	P-06080	0088381946827	25,00
	PZ1	25	10	P-06096	0088381944328	8,80
	PZ2	25	10	P-06111	0088381944335	8,80
	PZ3	25	10	P-06133	0088381944342	8,80
	PZ1	50	10	P-06105	0088381946834	25,00
	PZ2	50	10	P-06127	0088381944571	25,00
Plana	PZ3	50	10	P-06149	0088381944588	25,00
	LS0,6 X 4,5	25	10	P-06177	0088381946865	14,30
Hex.	LS0,8 X 5,5	25	10	P-06199	0088381946889	14,30
	3,0 mm.	25	10	P-21375	0088381948524	22,00
	4,0 mm.	25	10	P-21381	0088381948531	22,00
	5,0 mm.	25	10	P-21397	0088381948548	22,00
T	6,0 mm.	25	10	P-21406	0088381948555	22,00
	T10	25	10	P-06323	0088381947015	14,30
	T15	25	10	P-06339	0088381947022	14,30
	T20	25	10	P-06345	0088381947039	14,30
	T25	25	10	P-06351	0088381947046	14,30
	T27	25	10	P-06367	0088381947053	14,30
	T30	25	10	P-06373	0088381947060	14,30
	T40	25	10	P-06389	0088381947077	14,30

Portapuntas

Rapidfix

★★★★

- Sujeción segura y sin holgura del portapuntas.
- El mecanismo de sujeción especial de este portapuntas permite retener todo tipo de puntas con acople hexagonal de 1/4".
- Manejo con una mano, para un cambio rápido de la punta.
- Estilizado cuerpo de metal con casquillo funcional ergonómico. Aguanta las más duras condiciones de atornillado y taladrado.
- Recomendado para atornilladores de impacto.



Tipo	Long. (mm)	Inserción	Unds.	Código	EAN	P.V.P. (€)
Click	60	1/4"	1	P-54075	0088381984584	19,30

Clickfix

★★★★

- Magnético.
- Robusto cuerpo en aluminio.
- Sujeción segura de las puntas o brocas.
- Manejo con una sola mano.
- Casquillo de guía giratorio para un atornillado más fácil y seguro.



Tipo	Long. (mm)	Inserción	Unds.	Código	EAN	P.V.P. (€)
Imantado	60	1/4"	1	P-53263	0088381983778	18,70

Porta puntas 80mm para SDS-PLUS

★★★



Longitud (mm)	Inserción	Unds.	Código	EAN	P.V.P. (€)
80	SDS - PLUS	1	B-57548	0088381519151	6,60

Estándar

★★

- Magnético.
- Robusto cuerpo metálico.
- Sujeción segura de las puntas.



Tipo	Long. (mm)	Inserción	Unds.	Código	EAN	P.V.P. (€)
Imantado	60	1/4"	1	784811-8	0088381430807	4,00
	75	1/4"	1	784801-1	0088381114738	3,40

Portapuntas flexible

★★★

- Portapuntas magnético.
- Ideales para realizar atornillados en esquinas o bordes de difícil acceso.
- El eje se puede doblar para conseguir llegar a lugares estrechos donde es complicado el atornillado.



Tipo	Long. (mm)	Inserción	Unds.	Código	EAN	P.V.P. (€)
Magnético	200	1/4"	1	B-29072	0088381415507	7,30
Magnético	300	1/4"	1	B-29094	0088381415521	9,10

- Especial impacto.

★★★★★



Tipo	Long. (mm)	Inserción	Unds.	Código	EAN	P.V.P. (€)
Magnético	300	1/4"	1	B-51867	0088381466806	36,00



Vasos especiales colocación en varilla roscada

★★★

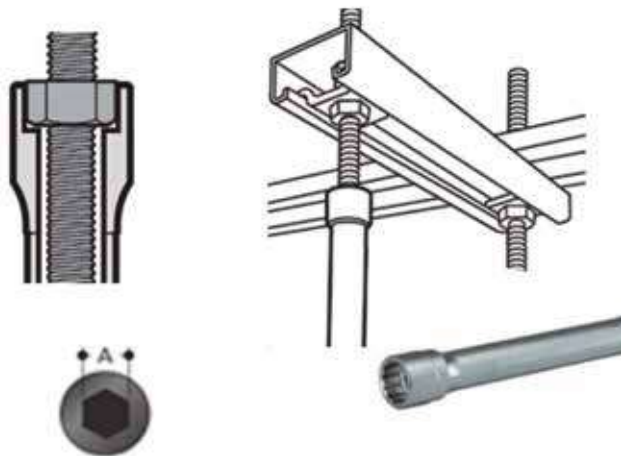

Ø (mm)	Long. (mm)	Inserción	Unds.	Código	EAN	P.V.P. (€)
10	150	1/4"	1	B-52532	0088381469111	27,00
10	300	1/4"	1	B-52548	0088381469128	29,00
10	500	1/4"	1	B-52554	0088381469135	49,00
13	150	1/4"	1	B-52582	0088381469166	27,00
13	300	1/4"	1	B-52598	0088381469173	29,00
13	500	1/4"	1	B-52607	0088381469180	49,00
17	150	1/4"	1	B-52635	0088381469210	29,00
17	300	1/4"	1	B-52641	0088381469227	32,00
17	500	1/4"	1	B-52657	0088381469234	51,00



Llaves de vaso 1/4" magnéticos

★★



Tornillo	Ø (mm)	Longitud (mm)	Unds.	Código	EAN	P.V.P. (€)
M3	5,5	50	1	B-38685	0088381433327	2,40
M3,5	6	50	1	B-38691	0088381433334	2,40
M4	7	50	1	B-38700	0088381433341	4,80
M5	8	50	1	B-38716	0088381433358	2,45
M6	10	50	1	B-38722	0088381433365	2,40
M8	12	50	1	B-38738	0088381433372	2,45
M8	13	50	1	B-38744	0088381433389	4,90
M10	17	50	1	B-38750	0088381433396	4,90
Para modelo FS2500 y FS2700						
M6	10	65	1	784806-1	0088381114585	22,00
1/2"	12,7	65	1	784805-3	0088381102735	24,00

Kit de ensamblaje rápido

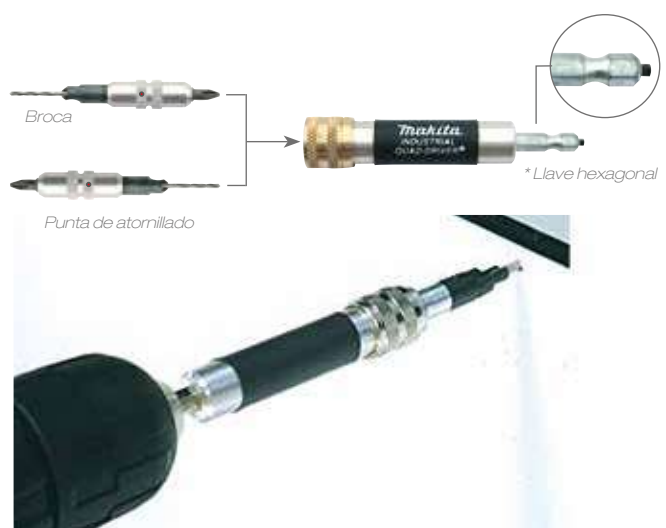

Ø (mm)	Unds.	Código	EAN	P.V.P. (€)
8	1	P-44074	0088381974271	12,70



Llaves de vaso para colocación de varilla roscada

★★★★★



Ø (mm)	Inserción	Unds.	Código	EAN	P.V.P. (€)
6	1/4"	1	B-42961	0088381441995	19,30
8	1/4"	1	B-42977	0088381442008	20,00
10	1/4"	1	B-42983	0088381442015	20,00

Set de llaves de vaso hexagonal

★★



Tamaño (mm)	Longitud (mm)	Unds.	Código	EAN	P.V.P. (€)
8 - 10 - 12 - 13	48	1	B-57554	0088381519168	6,70

Guía de atornillado

★★



B-52934

B-48773

Adaptador cambio de inserción

★★



Descripción	Unds.	Código	EAN	P.V.P. (€)
Adaptador 1/4 a 3/8"50mm.	1	B-54667	0088381478380	2,90
Adaptador 1/4 a 1/2"50mm.	1	B-54673	0088381478397	3,80
Adaptador 1/4 a 3/8"150mm.	1	B-57738	0088381521994	9,30
Adaptador 1/4 a 1/2"150mm.	1	B-57744	0088381522007	11,40

Adaptador cambio de inserción



Descripción	Unds.	Código	EAN	P.V.P. (€)
Adaptador 1/4 a 1/4" 50mm.	1	D-74740	0088381589512	1,65



Contenido	Longitud (mm)	Unds.	Código	EAN	P.V.P. (€)
Guía 80 mm	80	1	B-48751	0088381455756	5,10
Guía 120 mm	120	1	B-52934	0088381471312	5,80
Guía 120 mm	120	1	B-48767	0088381455763	6,40
Guía 80 mm 5 PH2 5 PZ2 5 T20 5 T25 5 T30	80	1	B-48773	0088381455770	17,50
Guía 120 mm 5 PH2 5 PZ2 5 T20 5 T25 5 T30	120	1	B-48789	0088381455787	17,50

Estuche de puntas (7 pcs) ★★



- Puntas 25mm: PH1, PH2, SL3, SL5, PZ2 y PZ3.
- Compacta e ideal para transportarla.
- Contenido visible gracias a la cubierta transparente.
- Portapuntas magnético.

Contenido	Unds	Código	EAN	P.V.P. (€)
6 puntas + portapuntas	1	D-73271	0088381582391	4,40

Bote de puntas imantadas a granel ★★ ★

- 100 Puntas dobles imantadas.
- Disponibles en el tipo PH nº2 y en PZ nº2.
- Inserción de ¼" hexagonal válida para atornilladores de impacto y taladros atornilladores.
- Puntas dobles de 65mm de largo.



Longitud (mm)	Tipo	Unds.	Código	EAN	P.V.P. (€)
65	Doble PH2	1	D-31669	0088381356503	54,00
65	Doble PZ2	1	D-34914	0088381367080	54,00

Bote de puntas a granel ★★

- Disponibles en el tipo PH nº2 y en PZ nº2 de 25mm y 50mm.
- Puntas imantadas de 25mm de largo.



Longitud (mm)	Tipo	Unds.	Código	EAN	P.V.P. (€)
25	PH2	100	B-24876	0088381409193	29,00
25	PZ2	100	B-24882	0088381409209	29,00
50	PH2	50	B-26490	0088381410229	28,00
50	PZ2	50	B-26509	0088381410236	28,00

Estuches de puntas ★★



Punta	Unds.	Código	EAN	P.V.P. (€)
31 piezas por estuche: 1xPH0, 1xPH1, 4xPH2, 1xPH3 1xPZ0, 1xPZ1, 4xPZ2, 1xPZ3 1xT10, 1xT15, 2xT20, 2xT25, 1xT27, 1xT30, 1xT40 1xH3, 1xH4, 1xH5, 1xH6 Planas: 4,5 / 5,5 / 6,5 Portapuntas magnético	12	E-00022	0088381553155	235,00
	1	B-68317	0088381545983	25,00



Punta	Unds.	Código	EAN	P.V.P. (€)
31 Piezas: 2xPh1, 4xPh2, 1xPh3 2xPz1, 5xPz2, 1xPz3 2xT10, 2xT15, 2xT20 3xT25, 2xT30, 1xT40 4 5,5 6,5mm Portapuntas magnético	1	D-30667	0088381354295	12,10

Puntas dobles imantadas ★★ ★

- Pack con diez puntas dobles con dispensador.
- 10 puntas dobles imantadas.
- Inserción de ¼" hexagonal válida para atornilladores de impacto y taladros atornilladores.
- Punta doble de 65mm de largo.



Medida (mm)	Tipo de punta	Unds.	Código	EAN	P.V.P. (€)
65	Doble PH2	1	D-34366	0088381365550	9,80

Estuche de puntas (11 pcs). ★★

- Portapuntas magnético.
- Punta PH2.
- Puntas PZ: PZ1, PZ2 y PZ3.
- Puntas T: T10, T15, T20, T25, T30 y T40.



Medida (mm)	Contenido	Unds.	Código	EAN	P.V.P. (€)
25	11 piezas	1	D-64995	0088381533782	10,40

Estuche de puntas (11 pcs).

★★★★

- Portapuntas magnético.
- PH2
- PZ1
- PZ2



Medida (mm)	Contenido	Unds.	Código	EAN	P.V.P. (€)
25	11 piezas	1	P-16782	0088381932783	17,10

Estuche de puntas y vasos

★★★

- Puntas PZ: PZ1x2, PZ2x2, PZ3x2.
- Puntas PH: PH1x2, PH2x2, PH3x2.
- Puntas hexagonales: H2, H2.5, H3, H4x2, H5x2, H6x2.
- Puntas planas: SL4.5x2, SL5.5x2, SL6.5x2.
- Puntas T: T10x2, T15x2, T20x2, T25x2, T30x2, T40
- Llaves de vaso: Hex5, Hex6, Hex7, Hex8, Hex9, Hex10, Hex11.
- Portapuntas magnético.
- Destornillador manual con carraca.



Contenido	Unds.	Código	EAN	P.V.P. (€)
47 piezas	1	B-36170	0088381433549	33,00

Estuche de puntas y llave de carraca

★★★

- Puntas PZ1, PZ2.
- Puntas PH1, PH2, PH3.
- Puntas hexagonales H4, H6.
- Puntas planas SL0,8x5.5, SL1,2x6.5.
- Puntas T T20, T25, T30.
- Llaves de vaso Hex5, Hex6, Hex8, Hex10, Hex12, Hex13.
- Punta 1/4"Hex.
- Portapuntas magnético
- Carraca.



Contenido	Unds.	Código	EAN	P.V.P. (€)
21 piezas	1	B-54081	0088381476966	36,00

Destornilladores de golpe

- Ideal para tornillos fuertemente apretados que no se pueden desatornillar con herramientas eléctricas o que son muy complicados de liberar con un destornillador manual.
- Aprovecha la fuerza del impacto para generar una fuerza contraria que termina por desatornillar el tornillo. Dispone de un muelle en el interior que al recibir el golpe del martillo, se comprime y libera dicha fuerza en forma de giro.



Punta	Longitud (mm)	Unds.	Código	EAN	P.V.P. (€)
PH2	125	1	B-42438	0088381440226	20,00
PZ2	125	1	B-42450	0088381440240	20,00

Estuche de puntas

★★

- Puntas PZ PZ0, PZ1, PZ2x2, PZ3.
- Puntas PH PH0, PH1, PH2x2, PH3.
- Puntas hexagonales H3, H4, H5, H6.
- Puntas planas SL4, SL4.5, SL5.5, SL6.5
- Puntas T T10, T15, T20x2, T25x2, T27, T30x2, T40
- Puntas T de seguridad T10H, T15H, T20H, T25H, T27H, T30H, T40H.
- Portapuntas magnético.



Contenido	Unds.	Código	EAN	P.V.P. (€)
37 piezas	1	B-28606	0088381414807	24,00

Set herramientas manuales (87 pcs)

★★★

- Llave de carraca 1/2".
- Llave de carraca con doble inserción 1/4" y 3/8".
- Llave portapuntas manual 152 mm.
- Llave manual ajustable 150 mm.
- Alicates 150 mm.
- Llaves combinadas manuales 10 - 12 - 13 - 14 - 17 mm.
- Set de llaves allen 1,5 - 2 - 2,5 - 3 - 4 - 5 - 6 - 8 mm.
- Destornilladores manuales PH1, PH2, PZ2 y plano 1.0 - 6.0.
- Desatornillador para carburadores.
- Vasos 1/4": 5 - 6 - 7 - 8 - 9 - 10 - 11 - 12 - 13 mm.
- Vasos largos 1/2": 8 - 10 - 12 - 13 - 15 - 17 - 19 mm.
- Portapuntas y portapuntas magnético.
- Puntas PH, PZ, T y TH.
- Adaptador 1/4".



Contenido	Unds	Código	EAN	P.V.P. (€)
87 piezas	1	E-08458	0088381575638	163,00

Set herramientas manuales (76 pcs)

★★★

- Llave de carraca 3/8"
- Destornillador para puntas 1/4
- Cúter
- Desatornillador para vasos 1/4"
- Martillo 180mm
- Alicates 150 mm.
- Alicates de punta de aguja 150mm
- Vasos largos 3/8": 8mm - 9mm - 10mm - 11mm - 12mm - 13mm - 14mm - 15mm - 16mm - 17mm - 18mm - 19mm - 20mm - 21mm
- Vasos 1/4": 4 - 5 - 6 - 7 - 8
- Portapuntas magnético.
- Set de llaves de vaso 1/4": 5 - 6 - 7 - 8 - 9 - 10 - 11
- Adaptador de vaso 1/2" 1/4" - 3/8"
- Puntas 25mm 1/4": PH1 - PH2 - PH3 - T8 - T9 - T10 - T15 - T20 - T25 - T27 - T30 - T40 - T8H - T10H - T15H - T20H - T25H - T27H - T30H - T40H - SL 0,5X3,0 - SL 0,8X4,0 - SL 0,8X5,0 - SL 1,0X5,5 - SL 1,0X6,0
- Extensores para vasos 3/8" 75mm 150mm
- Rótulas 1/4" y 3/8".



Contenido	Unds	Código	EAN	P.V.P. (€)
76 piezas	1	E-10899	0088381581493	109,00



Estuche de puntas y vasos (30 pcs)

- Puntas 25 mm PH, PZ, T, Hex y planas. ★★
- Puntas 50 mm PH, PZ, T y planas.
- Portapuntas magnético.
- Adaptador para vasos 3/8".
- Vasos 3/8" 63 mm: 17 y 19 mm.
- Vasos 1/4" hex. magnéticos 8 y 10 mm.



Contenido	Unds	Código	EAN	P.V.P. (€)
30 piezas	1	E-07060	0088381571265	33,00

Set de llaves, puntas y vasos 221pcs

- Llave de carraca 1/4" y 1/2". ★★★
- Llave manual 1/4".
- Extensiones para vasos 1/4" y para vasos 1/2".
- Adaptador 3 posiciones de 1/2" a 3/8".
- Rótulas de 1/4" y 1/2".
- Vasos 1/4" de 25 mm: 4, 4.5, 5, 5.5, 6, 7, 8, 9, 10, 11, 12, 13 y 14.
- Vasos 1/2" de 38 mm: 15, 16, 17, 19, 20, 21, 22, 24, 27, 30 y 32.
- Vasos estrella 1/2" de 38 mm: E10, E12, E14, E16, E18, E20 y E24.
- Vasos 1/4" hex. de 38 mm: 5, 5.5, 6, 7, 8, 9, 10, 11, 12 y 13.
- Llaves fijas combinadas de 8 a 19 mm.
- Set de llaves allen de 1.5 a 8 mm.
- Mango destornillador.
- Puntas planas, PH, PZ, T, Hex...
- Portapuntas magnético.



Contenido	Unds	Código	EAN	P.V.P. (€)
221 piezas	1	E-10883	0088381581486	215,00

Maletín de herramienta manual 120 piezas

- Llave de carraca 3/8".
- Vasos 1/4" 25mm: 4, 4.5, 5, 5.5, 6, 7, 8, 9, 10, 11, 12, 13 y 14mm.
- Vasos 3/8" 28 y 30mm: 8, 9, 10, 11, 12, 13, 14, 15, 16, 17, 18, 19, 20 y 21mm.
- Vasos estrella 1/4" 25mm: E4, E5, E6, E7 y E8.
- Vasos estrella 3/8" 28 y 30mm: E10, E11, E12, E14, E16 y E18.
- Vasos largos 1/2" de 16 y 21mm.
- Adaptadores 3/8", 1/4" y 1/2".
- Extensiones para vasos 1/4" y para vasos 3/8".
- Rótulas de 1/4" y 3/8".
- Llaves fijas combinadas de 8, 10, 11, 12, 13, 14 y 15mm.
- Llave manual 1/4".
- Portapuntas magnético y guía de atornillado.
- Puntas planas, PH, PZ, T, Hex...



Contenido	Unds	Código	EAN	P.V.P. (€)
120 piezas	1	E-06616	0088381570251	138,00



Maletín de herramienta manual (120 pcs)

- Llave de carraca 3/8".
- Destornillador manual 1/4".
- Vasos 3/8": 8 - 9 - 10 - 11 - 12 - 13 - 14 - 15 - 16 - 17 - 18 - 19 - 20 - 21 mm.
- Vasos 1/4": 4 - 4,5 - 5 - 5,5 - 6 - 7 - 8 - 9 - 10 - 11 - 12 - 13 - 14 mm.
- Vasos 1/4": E4 - E5 - E6 - E7 - E8. Vasos 3/8": E10 - E11 - E12 - E14 - E16 - E18.
- Adaptador de 3/8" a 1/2" y dos vasos largos de 16 y 21 mm.
- Extensiones 3/8" de 75 y 150 mm.
- Extensiones 1/4" de 50 y 100 mm.
- Adaptadores móviles de 3/8" y 1/4".
- Portapuntas y portapuntas magnético.
- Puntas PH, PZ, T, TH, HH y planas.
- Llaves manuales 8 - 10 - 11 - 12 - 13 - 14 - 15 mm.
- Juego de llaves allen 1,5 - 2 - 2,5 - 3 - 4 - 5 - 6 - 8 mm.

★★★★



Contenido	Unds	Código	EAN	P.V.P. (€)
120 piezas	1	E-08713	0088381576727	150,00

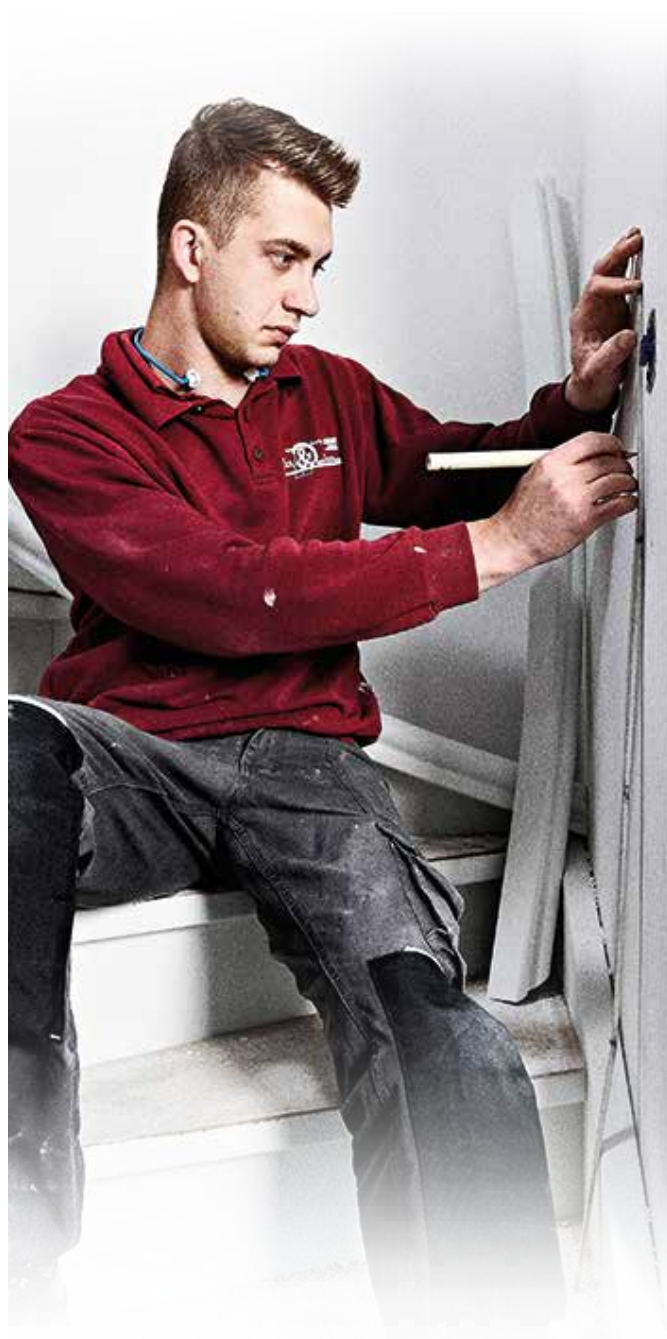

Llaves de vaso CR-MO (sin arandela ni bulón)



★★★



★★★

*No incluye bulón ni arandela goma.

Inserción	Métrica	Ø int (mm)	Ø ext (mm)	Long. (mm)	Código	EAN	P.V.P. (€)
3/8"	-	6	11	28	B-39883	0088381436595	3,80
3/8"	-	7	12	28	B-39899	0088381436601	3,80
3/8"	-	8	13	28	B-39908	0088381436618	3,80
3/8"	-	9	14	28	B-39914	0088381436625	3,80
3/8"	-	10	15	28	B-39920	0088381436632	3,80
3/8"	-	11	18	28	B-39936	0088381436649	3,80
3/8"	M7	12	18	28	B-39942	0088381436656	3,70
3/8"	M8	13	20	28	B-39958	0088381436663	4,40
3/8"	M8	14	20	28	B-39964	0088381436670	4,40
3/8"	-	15	22	28	B-39970	0088381436687	4,70
3/8"	-	16	24	28	B-39986	0088381436694	4,70
3/8"	M10	17	24	28	B-39992	0088381436700	4,70
3/8"	-	18	28	28	B-40004	0088381436717	5,20
1/2"	-	10	15	38	B-40076	0088381436786	3,20
1/2"	M7	12	18	38	B-40098	0088381436809	3,20
1/2"	M8	13	20	38	B-40107	0088381436816	3,20

Inserción	Métrica	Ø int (mm)	Ø ext (mm)	Long. (mm)	Código	EAN	P.V.P. (€)
1/2"	M8	13	20	81,5	B-52180	0088381467827	3,70
1/2"	M8	14	20	38	B-40113	0088381436823	3,20
1/2"	M10	16	24	38	B-40135	0088381436847	3,70
1/2"	M10	17	24	38	B-40141	0088381436854	3,70
1/2"	M10	17	24	81,5	B-52211	0088381467858	4,80
1/2"	M12	19	28	38	B-40163	0088381436878	4,00
1/2"	M12	19	28	81,5	B-52233	0088381467872	5,60
1/2"	M14	21	30	38	B-40185	0088381436892	4,00
1/2"	M14	21	30	81,5	B-52249	0088381467889	6,40
1/2"	M14	22	30	38	B-40191	0088381436908	4,50
1/2"	M14	23	30	38	B-40200	0088381436915	5,90
1/2"	M16	24	30	38	B-40216	0088381436922	6,20
1/2"	M18	27	36	42	B-40222	0088381436939	6,40
1/2"	M20	30	40	443844	B-40238	0088381436946	7,20
1/2"	M22	32	42	38	B-40244	0088381436953	10,40

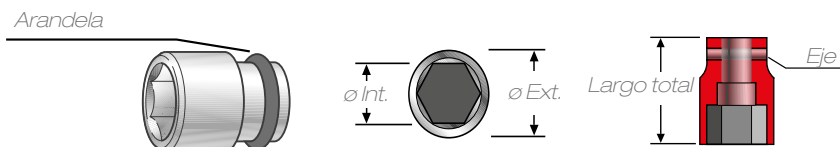

Arandela de goma - Bulón



Tipo	Código	EAN	P.V.P. (€)
A	213397-0	-	1,20
B	213398-8	0088381155496	1,20
C	213399-6	0088381495240	1,20
D	213461-7	3240890114174	1,20
E	213514-2	0088381495264	1,20
F	213570-2	0088381200028	1,60

Tipo	Código	EAN	P.V.P. (€)
1	268056-1		1,20
2	268057-9	0088381162708	1,20
3	256283-2		1,20
4	256282-4	0088381495431	1,20
5	256284-0	0088381200035	2,10

Llaves de vaso (incluye arandela y bulón) sin clip



★★★★



Tipo	Inserción	Métrica	Ø int (mm)	Ø ext (mm)	Long. (mm)	Código	EAN	P.V.P. (€)	
A	1	1/2"	M7	12	19	38	A-89931	0088381185882	4,40
		1/2"	M7	12	25	75	134867-5	0088381152488	35,00
		1/2"	M8	13	25	38	134825-1	0088381148948	5,20
		1/2"	M8	13	26	52	134827-7	0088381148955	6,90
		1/2"	M8	14	25	38	134826-9	0088381160704	5,20
		1/2"	M8	14	25	52	134828-5	0088381170178	5,50
		1/2"	-	16	25	38	B-10506	0088381343299	5,20
		1/2"	M10	17	26	38	134829-3	0088381148962	5,20
		1/2"	M10	17	26	52	134830-8	0088381148979	5,20
B	1/2"	M12	19	28	38	134831-6	0088381148986	6,00	
		M12	19	28	52	134832-4	0088381148993	6,00	
C	1/2"	M12	19	30	78	134837-4	0088381161824	8,60	
B	1/2"	M14	21	28	52	134833-2	0088381161794	7,70	
C	1/2"	M14	21	30	78	134839-0	0088381161831	9,40	
B	1/2"	M14	22	30	38	134851-0	0088381149006	6,90	
C	1/2"	M14	22	28	52	134834-0	0088381149013	7,70	
B	1/2"	M14	23	30	38	134840-5	0088381161800	6,90	
B	1/2"	M14	23	28	52	134835-8	0088381170499	8,20	
C	2	1/2"	M16	24	30	45	134841-3	0088381149020	8,20
		1/2"	M16	24	28	52	134836-6	0088381149037	8,60
C	1	1/2"	M16	26	30	50	134842-1	0088381161770	9,10
		1/2"	M16	26	30	75	134843-9	0088381161817	11,60
		1/2"	M18	27	30	50	134844-7	0088381149044	8,20
		1/2"	M18	27	30	78	134845-5	0088381149051	12,70
		1/2"	M20	30	30	50	134846-3	0088381149068	9,90
		1/2"	M20	30	30	78	134847-1	0088381149075	13,20
		1/2"	M22	32	30	50	134848-9	0088381149082	9,60
		1/2"	M22	32	30	78	134849-7	0088381149099	13,80

Tipo	Inserción	Métrica	Ø int (mm)	Ø ext (mm)	Long. (mm)	Código	EAN	P.V.P. (€)	
D	3	3/4"	M10	17	28	50	A-85494	0088381158817	10,50
E	4	3/4"	M10	17	31	95	A-85503	0088381158824	21,00
D	3	3/4"	M12	19	30	50	A-85519	0088381158831	11,00
E	4	3/4"	M12	19	33	95	A-85525	0088381158848	21,00
D	3	3/4"	M14	21	32	52	A-85531	0088381158855	11,00
E	4	3/4"	M14	21	35	95	A-85547	0088381158862	21,00
D	3	3/4"	M14	22	34	52	A-85553	0088381158879	11,00
E	4	3/4"	M14	22	37	95	A-85569	0088381158886	21,00
D	3	3/4"	M16	24	36	52	A-85575	0088381158893	11,00
E	4	3/4"	M16	24	39	95	A-85581	0088381158909	20,00
D	3	3/4"	M16	26	38	52	134853-6	0088381149105	12,10
E	4	3/4"	M16	26	44	95	134854-4	0088381149112	25,00
D	3	3/4"	M18	27	38	52	134855-2	0088381149129	11,00
E	4	3/4"	M18	27	44	95	134856-0	0088381149136	22,00
		3/4"	M20	30	44	52	134857-8	0088381149143	11,00
		3/4"	M20	30	44	95	134858-6	0088381149150	19,30
		3/4"	M22	32	44	52	134871-4	0088381149167	11,00
F	5	3/4"	M22	32	44	95	134859-4	0088381149174	20,00
		3/4"	M22	35	44	56	134860-9	0088381149181	14,30
		3/4"	M22	35	44	95	134861-7	0088381149198	27,00
		3/4"	M24	36	44	56	134862-5	0088381149204	16,00
		3/4"	M24	36	44	95	134863-3	0088381149211	24,00

Tipo	Inserción	Métrica	Ø int (mm)	Ø ext (mm)	Long. (mm)	Código	EAN	P.V.P. (€)	
F	5	1"	M22	35	52	80	134864-1	0088381200882	25,00
		1"	M24	36	52	80	134865-9	0088381200899	24,00
		1"	M27	41	52	80	134872-2	0088381200011	26,00

Estuche de llaves de vaso 9 piezas

★★★★

- Estuche de 9 piezas con espuma interior para una buena conservación de los vasos.
- Cada vaso monta su propia goma y bulón, para una sujeción perfecta a la máquina.
- Información de la composición: CR-MO (Cromo - molibdeno)



Inserción	Ø int. (mm)	Ø ext. (mm)	Long. (mm)	Código	EAN	P.V.P. (€)
1/2"	8	15	38	D-41517	0088381404334	58,00
1/2"	10	17,5	38			
1/2"	13	20	38			
1/2"	16	24	38			
1/2"	17	26	38			
1/2"	18	28	38			
1/2"	19	28	38			
1/2"	21	30	38			
1/2"	24	34	38			

Juego de vasos de impacto 12 piezas



Inserción	Ø int. (mm)	Long. (mm)	Código	EAN	P.V.P. (€)
1/4"	6	23	E-12289	0088381589529	14,90
	7	23			
	8	23			
	10	23			
	11	23			
	12	23			
	13	23			



Juego de llaves de vaso para automóvil

★★★



Inserción	Ø int. (mm)	Ø ext. (mm)	Long. (mm)	Código	EAN	P.V.P. (€)
1/2"	3	17	86	E-12354	0088381586528	33,00
1/2"		19				
1/2"		21				

Adaptadores de inserción para DWR180 Y WR100D



Modelos	Unds.	Código	EAN	P.V.P. (€)
Para vasos 3/8"	1	191A50-3	0088381546744	22,00
Para vasos 1/4"	1	191A51-1	0088381546737	22,00

Tope de profundidad para atornilladores de impacto



Modelos	Unds.	Código	EAN	P.V.P. (€)
TD0101F DTD145 DTD146	1	194281-7	0088381276108	30,00

Accesorios para DTL061



134745-9

192439-2

192440-7

Descripción	Unds.	Código	EAN	P.V.P. (€)
Adaptador de 3/8"	1	134745-9	0088381134361	20,00
Adaptador 1/2"	1	134746-7	0088381142632	20,00
Cabezal de carraca	1	192439-2	0088381128742	165,00
Cabezal recto	1	192440-7	0088381128759	74,00

Extensión



Inserción	Longitud (mm)	Unds.	Código	EAN	P.V.P. (€)
1/2"	100	1	134874-8	0088381149228	25,00
3/4"	150	1	134997-2	0088381194730	52,00
1"	200	1	134870-6	0088381150200	72,00

Rótula



Inserción	Longitud (mm)	Unds.	Código	EAN	P.V.P. (€)
1/2"	80	1	134877-2	0088381149242	71,00
3/4"	105,5	1	134998-0	0088381206891	107,00

Cambios de inserción



P-05941



P-05963



B-68448

Inserción	Salida	Longitud (mm)	Unds.	Código	EAN	P.V.P. (€)
1/2"	1/4"	47	1	P-05941	0088381946681	46,00
3/8"	1/4"	37	1	P-05963	0088381946704	40,00
1/2"	1/4"	47	1	B-68448	0088381546287	17,30



Mango de extensión



Modelo	Longitud (mm)	Unds.	Código	EAN	P.V.P. (€)
6844 6842 DFR440 DFR550	890 - 990	1	194500-1	0088381342377	89,00

Gancho para cinturón



Modelos	Unds.	Código	EAN	P.V.P. (€)
DTD129 DTD148 DTD154 DTD170 DTD171 DTD172	1	197043-2	0088381447362	32,00

Protector traslúcido



Modelo	Medidas (mm)	Unds.	Código	EAN	P.V.P. (€)
DTW700 DTW701 TW007G TW008G	807 - 657x243x172 mm	1	413G39-0	0088381595063	27,00

Mango de extensión



Modelo	Medidas (mm)	Unds.	Código	EAN	P.V.P. (€)
DTW1001 DTW1002 DTW700 DTW701 TW001G TW007G TW008G	807 - 657x243x172 mm	1	191G67-2	0088381568302	138,00



Portabrocas automático - 1/4" hexagonal



763198-1



784643-3

Inserción	Capacidad (mm)	Paso	Tipo	Código	EAN	P.V.P. (€)
1/4"hex	1,0 - 10	3/8"	Automático	763198-1	0088381256070	28,00
Adaptador	1/2"	3/8"	-	784643-3	0088381248013	5,00

Cable conector



Modelos	Long. (mm)	Calidad	Unds.	Código	EAN	P.V.P. (€)
FS6300R	4	Standard	1	699020-5	3240890265913	13,40
	10	Standard	1	194330-0	0088381289863	26,00
	10	Alta	1	194906-3	0088381354066	40,00

Bocas atornillado



Modelos	Para	Medida	Unds.	Código	EAN	P.V.P. (€)
FS2500	Vaso	1/4"	1	450963-4	0088381365093	1,95
		5/16"	1	450967-6	0088381468633	1,30
		3/8"	1	450968-4	0088381365109	1,30
	Punta	60 mm	1	122867-7	3240890367600	6,50
		75 mm	1	122868-5	-	7,20
FS2300 FS4200 FS6300R	Punta	60 mm	1	158875-2	3240890322227	7,20
		75 mm	1	158876-0	0088381468558	7,80
FS2700	Puntas 50 mm	-	1	322120-3	0088381162753	8,60
		1/4"	1	322124-5	3240890027573	13,20
	Vaso	5/16"	1	322125-3	-	13,80
		3/8"	1	322119-8	3240890083586	20,00
		7/16"	1	322126-1	-	14,90

Anillo cierre para bocas de atornillado*



*necesario para todas las bocas de atornillado, excepto vasos para FS2700

Unds.	Código	EAN	P.V.P. (€)
1	455591-0	-	2,00

Empuñadura auxiliar



Modelo	Longitud (mm)	Unds.	Código	EAN	P.V.P. (€)
6906	110	1	122464-9	0088381152495	18,70
TW1000	110	1	122727-3	0088381199988	22,00



Limpiar y Cepillar



Gratas para taladros



Makita

Gratas

Material



Alambre de acero ondulado

- Recomendado para la eliminación del óxido, barnices, esmaltes... de superficies metálicas.



Nylon grueso

- Perfecto para la limpieza de óxido, barnices, esmaltes... de superficies de metal, madera y PVC.



Nylon fino

- Para un acabado más suave.
- Válido para madera, metal y PVC.

Forma



Cepillos de acabado

- Perfecto para superficies estrechas o de difícil acceso.



Copa ondulada

- Ideal para la limpieza de superficies planas o rugosas.



Cepillos de púas

- Para superficies planas.
- Recomendado para la madera.



Cepillo oblicuo

- Idóneo para la limpieza de superficies estrechas, bordes o ranuras.



Alambre trenzado



Alambre



Alambre latonado



Nylon grueso G80



Nylon fino G240

	Alambre trenzado	Alambre	Alambre latonado	Nylon grueso G80	Nylon fino G240
Indicado para	Ideal para metal y trabajos pesados	Ideal para metal y trabajos suaves	Ideal para metal y madera. Alambre resistente a la oxidación.	Ideal para el óxido ligero de metal, madera y PVC.	Ideal para el acabado de materiales, madera y PVC.
Eficiencia	Muy alta eficiencia	Alta eficiencia	Alta eficiencia	Baja eficiencia	Muy baja eficiencia
Acabado	Muy basto	Basto	Basto	Limpio	Muy limpio
Madera	X	X	✓	✓	✓
PVC	X	X	◆	✓	✓
Metal	✓	✓	✓	✓	✓

✓ : Recomendado ◆ : Válido X : No recomendado

Gratas para taladros

Cepillos de acabado de nylon ★★

- Ideal para superficies estrechas o de difícil acceso. Eliminación de óxido, esmaltes, barnices, etc. Tanto en metales, plásticos o maderas.



Ø (mm)	Inserción (mm)	Grano	Espesor (mm)	Tipo	Unds.	Código	EAN	P.V.P. (€)
12	6	80	1,4	Nylon	1	D-45668	0088381408875	3,20
17	6	80	1,4	Nylon	1	D-45674	0088381408882	4,10
24	6	80	1,4	Nylon	1	D-45680	0088381408899	4,70
30	6	80	1,4	Nylon	1	D-45696	0088381408905	6,40
12	6	240	0,7	Nylon	1	D-45705	0088381408912	3,20
17	6	240	0,7	Nylon	1	D-45711	0088381408929	4,10
24	6	240	0,7	Nylon	1	D-45727	0088381408936	4,70
30	6	240	0,7	Nylon	1	D-45733	0088381408943	6,40

Cepillos de acabado de alambre ★★

- Muy eficaz para superficies estrechas y de difícil acceso. Alambres ondulados para que la superficie terminada quede mucho más suave.



Ø (mm)	Inserción (mm)	Grano	Espesor (mm)	Tipo	Unds.	Código	EAN	P.V.P. (€)
12	6	-	-	Alambre	1	D-40004	0088381400121	1,75
19	6	-	-	Alambre	1	D-40010	0088381400138	2,05
25	6	-	-	Alambre	1	D-40026	0088381400145	2,60
30	6	-	-	Alambre	1	D-40032	0088381400152	2,90

Cepillos de acabado de alambre latonado ★★

- Ideal para trabajar superficies estrechas y de difícil acceso.
- Más blandas, ideal para madera.



D-73710

D-73726

D-73732

Ø (mm)	Inserción (mm)	Grano	Espesor (mm)	Tipo	Unds.	Código	EAN	P.V.P. (€)
12	6	-	-	Latonado	1	D-73704	0088381586238	1,45
19	6	-	-	Latonado	1	D-73710	0088381586245	1,65
24	6	-	-	Latonado	1	D-73726	0088381586252	2,00
28	6	-	-	Latonado	1	D-73732	0088381586269	2,25

Cepillos de acabado de alambre trenzado ★★

- Ideal para superficies estrechas y de difícil acceso. Indicadas para metal.
- Alambre de acero más grueso para trabajos más exigentes.



D-73835

D-73841

D-73863

Ø (mm)	Inserción (mm)	Grano	Espesor (mm)	Tipo	Unds.	Código	EAN	P.V.P. (€)
12	6	-	-	Trenzada	1	D-73835	0088381586467	2,40
19	6	-	-	Trenzada	1	D-73841	0088381586474	3,10
24	6	-	-	Trenzada	1	D-73857	0088381586481	3,60
28	6	-	-	Trenzada	1	D-73863	0088381586498	4,80



Gratas para taladros

Cepillos de copa ondulada de nylon

★★

- Ideal para la limpieza de superficies planas o rugosas. Eliminación de óxido, esmaltes, barnices, etc. Tanto en metales, como en plásticos o maderas.



D-45543



D-45515

Ø (mm)	Inserción (mm)	Grano	Espesor (mm)	Tipo	Unds.	Código	EAN	P.V.P. (€)
50	6	80	1,4	Nylon	1	D-45509	0088381408714	5,20
63	6	80	1,4	Nylon	1	D-45515	0088381408721	7,00
75	6	80	1,4	Nylon	1	D-45521	0088381408738	8,10
50	6	240	0,7	Nylon	1	D-45537	0088381408745	5,20
63	6	240	0,7	Nylon	1	D-45543	0088381408752	7,00
75	6	240	0,7	Nylon	1	D-45559	0088381408769	8,10

Cepillos de copa ondulada de alambre

★★

- Muy eficaz para superficies planas o rugosas. Alambres ondulados para que la superficie terminada quede mucho más suave.



Ø (mm)	Inserción (mm)	Grano	Espesor (mm)	Tipo	Unds.	Código	EAN	P.V.P. (€)
38	6	-	-	Alambre	1	D-39908	0088381400022	2,10
50	6	-	-	Alambre	1	D-39914	0088381400039	2,35
63	6	-	-	Alambre	1	D-39920	0088381400046	2,60
75	6	-	-	Alambre	1	D-39936	0088381400053	2,90
80	6	-	-	Alambre	1	D-39942	0088381400060	3,50

Gratas de copa ondulada de alambre latonado

★★

- Muy eficaz para superficies planas. Adecuado para la eliminación de óxido, barnices...Especialmente para madera.



D-73601



D-73623



D-73645

Ø (mm)	Inserción (mm)	Grano	Espesor (mm)	Tipo	Unds.	Código	EAN	P.V.P. (€)
	6	-	-	Latonado	1	D-73601	0088381586139	1,55
50	6	-	-	Latonado	1	D-73617	0088381586146	1,80
63	6	-	-	Latonado	1	D-73623	0088381586153	2,00
75	6	-	-	Latonado	1	D-73639	0088381586160	2,25
80	6	-	-	Latonado	1	D-73645	0088381586177	2,80

Cepillos de copa ondulada de alambre trenzado

★★

- Muy eficaz para superficies planas. Adecuado para la eliminación de óxido, barnices...Especialmente para superficies metálicas.



D-73798



D-73807

Ø (mm)	Inserción (mm)	Grano	Espesor (mm)	Tipo	Unds.	Código	EAN	P.V.P. (€)
63	6	-	-	Trenzada	1	D-73798	0088381586429	5,00
75	6	-	-	Trenzada	1	D-73807	0088381586436	5,50

Cepillos de púas de nylon

★★

- Ideal para superficies planas. Eliminación de óxido, limpieza de zonas de soldadura, barnices, etc.



D-45755



D-45749

Ø (mm)	Inserción (mm)	Grano	Espesor (mm)	Tipo	Unds.	Código	EAN	P.V.P. (€)
100	6	80	1,4	Nylon	1	D-45749	0088381408950	8,80
100	6	240	0,7	Nylon	1	D-45755	0088381408967	8,80

Gratas para taladros

Cepillos oblicuos de nylon

★★

- Ideal para la limpieza en superficies estrechas, bordes o ranuras. Eliminación de óxido, esmaltes, barnices, etc. Tanto en metales, como en plásticos o maderas.



Ø (mm)	Inserción (mm)	Grano	Espesor (mm)	Tipo	Unds.	Código	EAN	P.V.P. (€)
38	6	80	1,4	Nylon	1	D-45565	0088381408776	4,10
50	6	80	1,4	Nylon	1	D-45571	0088381408783	5,00
63	6	80	1,4	Nylon	1	D-45587	0088381408790	5,20
75	6	80	1,4	Nylon	1	D-45593	0088381408806	7,00
100	6	80	1,4	Nylon	1	D-45602	0088381408813	8,10
38	6	240	0,7	Nylon	1	D-45618	0088381408820	4,10
50	6	240	0,7	Nylon	1	D-45624	0088381408837	5,00
63	6	240	0,7	Nylon	1	D-45630	0088381408844	5,20
75	6	240	0,7	Nylon	1	D-45646	0088381408851	7,00
100	6	240	0,7	Nylon	1	D-45652	0088381408868	8,10

Cepillos oblicuos de alambre

★★

- Muy eficaz para eliminar las rebabas y el óxido en trabajos finos.
- Alambres ondulados para que la superficie terminada quede mucho más suave.



Ø (mm)	Inserción (mm)	Grano	Espesor (mm)	Tipo	Unds.	Código	EAN	P.V.P. (€)
38	6	-	5	Alambre	1	D-39958	0088381400077	2,05
50	6	-	7	Alambre	1	D-39964	0088381400084	2,35
63	6	-	9	Alambre	1	D-39970	0088381400091	2,60
75	6	-	10	Alambre	1	D-39986	0088381400107	2,95
100	6	-	12	Alambre	1	D-39992	0088381400114	3,20

Cepillos oblicuos de alambre latonado

★★

- Muy eficaz para cepillar ranuras, especialmente en madera.



D-73651

D-73673

D-73695

Ø (mm)	Inserción (mm)	Grano	Espesor (mm)	Tipo	Unds.	Código	EAN	P.V.P. (€)
38	6	-	5	Latonado	1	D-73651	0088381586184	1,55
50	6	-	7	Latonado	1	D-73667	0088381586191	1,65
63	6	-	9	Latonado	1	D-73673	0088381586207	1,85
75	6	-	10	Latonado	1	D-73689	0088381586214	2,00
100	6	-	12	Latonado	1	D-73695	0088381586221	2,25

Cepillos oblicuos de alambre trenzado

★★

- Ideal para superficies estrechas y ranuras principalmente de metal.



D-73813

Ø (mm)	Inserción (mm)	Grano	Espesor (mm)	Tipo	Unds.	Código	EAN	P.V.P. (€)
75	6	-	-	Trenzada	1	D-73813	0088381586443	4,80
100	6	-	-	Trenzada	1	D-73829	0088381586450	5,00

Set de gratas de nylon para taladros

GRUESA (rojo) y FINA (azul)

★★

- Contiene copa ondulada 50 mm, cepillo oblicuo 50 mm y cepillo de acabado 24 mm.



Ø (mm)	Inserción (mm)	Grano	Espesor (mm)	Tipo	Unds.	Código	EAN	P.V.P. (€)
50	6	80	1,4	Nylon	1	D-70742	0088381556033	11,10
50	6	80	1,4	Nylon	1			
24	6	80	1,4	Nylon	1			

Ø (mm)	Inserción (mm)	Grano	Espesor (mm)	Tipo	Unds.	Código	EAN	P.V.P. (€)
50	6	240	0,7	Nylon	1	D-70758	0088381556040	11,10
50	6	240	0,7	Nylon	1			
24	6	240	0,7	Nylon	1			

Gratas para amoladoras

- Para la limpieza antes de la soldadura, oxidación y la limpieza de pintura, salpicaduras de soldadura. Eliminación de la corrosión del desbarbado, limpieza de barcos, tanques de acero, la preparación de superficies metálicas antes de pintar...



Forma



Copa ondulada

- Recomendado para la eliminación del óxido, barnices, esmaltes... de superficies metálicas.



Copa ondulada trenzada

- Alambre de acero más grueso para trabajos más exigentes que el tipo ondulado.
- Para superficies más amplias que el tipo recto.



Copa recta ondulada trenzada

- Para un acabado más suave
- Válido para madera, metal y PVC.



Cepillo oblicuo rizado

- Recomendado para la eliminación del óxido, barnices, esmaltes... de superficies metálicas en esquinas o lugares estrechos.



Cepillo oblicuo trenzado

- Alambre de acero más grueso para trabajos más exigentes que el cepillo oblicuo rizado.

Aplicación					
Madera	X	X	◆	X	X
PVC	X	X	◆	X	X
Metal	✓	✓	✓	✓	✓

✓ : Recomendado ◆ : Válido X: No recomendado

Gratas para amoladoras de acero

Copa ondulada de alambre ★★



- Para superficies planas o rugosas. Alambres ondulados para que la superficie terminada quede mucho más suave.

Ø (mm)	Inserción (mm)	Espesor (mm)	Tipo	Unds.	Código	EAN	P.V.P. (€)
60	M14	0,3	Acero	1	D-24072	0088381313674	4,10
75	M14	0,3	Acero	1	D-24094	0088381313698	4,70
100	M14	0,3	Acero	1	D-29284	0088381345835	6,70
60	M14	0,3	Acero latonado	1	D-39746	0088381399869	4,10
75	M14	0,3	Acero latonado	1	D-39768	0088381399883	4,70
90	M14	0,3	Acero latonado	1	D-39780	0088381399906	5,80
100	M14	0,3	Acero latonado	1	D-39805	0088381399920	7,60

Copa ondulada de alambre trenzado ★★



- Para superficies planas o rugosas. Alambre de acero más grueso que el tipo ondulado para trabajos más exigentes.

Ø (mm)	Inserción (mm)	Espesor (mm)	Tipo	Unds.	Código	EAN	P.V.P. (€)
60	M14	0,5	Acero	1	D-24119	0088381313711	5,60
75	M14	0,5	Acero	1	D-24131	0088381313735	6,20

Copa recta ondulada de alambre trenzado ★★



- Para superficies planas o rugosas. Alambre de acero más grueso que el tipo ondulado para trabajos más exigentes.

Ø (mm)	Inserción (mm)	Espesor (mm)	Tipo	Unds.	Código	EAN	P.V.P. (€)
60	M14	0,5	Acero	1	D-24153	0088381313759	7,00
100	M14	0,5	Acero	1	D-29290	0088381345842	10,20

Cepillo oblicuo de alambre rizado ★★



- Muy útil para limpiar esquinas o lugares estrechos donde los usuarios no pueden llegar con facilidad. Alambres oblicuos para que la superficie terminada quede mucho más suave.

Ø (mm)	Inserción (mm)	Espesor (mm)	Tipo	Unds.	Código	EAN	P.V.P. (€)
100	M14	0,3	Acero	1	D-39827	0088381399944	4,90
115	M14	0,3	Acero	1	D-39849	0088381399968	5,80

Cepillos oblicuo de alambre trenzado ★★



- Muy útil para limpiar esquinas o lugares estrechos donde los usuarios no pueden llegar con facilidad. Alambres oblicuos para que la superficie terminada quede mucho más suave.

Ø (mm)	Inserción (mm)	Espesor (mm)	Tipo	Unds.	Código	EAN	P.V.P. (€)
100	M14	0,5	Acero	1	D-39861	0088381399982	5,60
115	M14	0,5	Acero	1	D-39883	0088381400008	5,80
115	M14	0,5	Acero	1	D-29561	0088381346726	6,40
125	M14	0,5	Acero	1	D-29577	0088381346733	8,50
150	M14	0,5	Acero	1	D-45761	0088381410328	11,10
175	M14	0,5	Acero	1	D-45777	0088381410335	14,00

Cepillos de lija para taladros y amoladoras rectas



★★

- Indicados para taladros o amoladoras recta (con control de velocidad).



Ø (mm)	Inserción (mm)	Espesor (mm)	Altura (mm)	Unds.	Código	EAN	P.V.P. (€)
30	6	A40	10	1	D-75297	0088381594776	3,50
30	6	A60	10	1	D-75306	0088381594783	3,50
30	6	A80	10	1	D-75312	0088381594790	3,50
30	6	A120	10	1	D-75328	0088381594806	3,50
40	6	A40	20	1	D-75334	0088381594813	4,00
40	6	A60	20	1	D-75340	0088381594820	4,00
40	6	A80	20	1	D-75356	0088381594837	4,00
40	6	A120	20	1	D-75362	0088381594844	4,00
50	6	A40	20	1	D-75378	0088381594851	4,30
50	6	A60	20	1	D-75384	0088381594868	4,30
50	6	A80	20	1	D-75390	0088381594875	4,30
50	6	A120	20	1	D-75409	0088381594882	4,30
50	6	A40	30	1	D-75792	0088381597784	4,30
50	6	A60	30	1	D-75801	0088381597791	4,30
50	6	A80	30	1	D-75817	0088381597807	4,30
50	6	A120	30	1	D-75823	0088381597814	4,30
60	6	A40	30	1	D-75839	0088381597821	5,10
60	6	A60	30	1	D-75845	0088381597838	5,10
60	6	A80	30	1	D-75851	0088381597845	5,10
60	6	A120	30	1	D-75867	0088381597852	5,10

Rodillos para N9741

Rodillo alambre acero latonado



★★★★

- Ideal para veteado de maderas, duras o blandas. Adecuado para la abrasión fuerte de maderas blandas y duras. Para la desoxidación y limpieza.

Tipo	Unds.	Código	EAN	P.V.P. (€)
Acero latonado	1	P-65648	0088381996167	112,00

★★



Tipo	Unds.	Código	EAN	P.V.P. (€)
Acero latonado	1	D-73570	0088381586108	33,00

Rodillo púas acero



★★★★



- Para desoxidación. Eliminación de barniz. Limpieza de piezas de encofrado de hormigón.

Tipo	Unds.	Código	EAN	P.V.P. (€)
Acero	1	P-04400	0088381914246	116,00

Rodillo acero



★★

Tipo	Unds.	Código	EAN	P.V.P. (€)
Acero	1	D-73564	0088381586092	33,00

Rodillo de cerdas de fibra



- Para aplicación de nogalina y barniz y posterior pulido, así como abrillantado natural de madera.

Tipo	Unds.	Código	EAN	P.V.P. (€)
Fibra	1	P-04416	0088381914253	93,00

Rodillo de Nylon

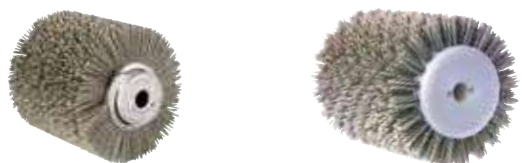

D-73586

P-04422



- Para estructurar madera blanda y repasar madera dura estructurada. Para resaltar la estructura de la madera y eliminar eventuales fibras de madera. Para el tratamiento previo óptimo de la superficie a la posterior aplicación de barniz y nogalina. Para realizar una superficie rectificada en acero inoxidable y aluminio.

Grano	Tipo	Calidad	Unds.	Código	EAN	P.V.P. (€)
60	Nylon	★★★★	1	D-73586	0088381586115	40,00
60	Nylon	★★★★	1	P-04422	0088381914260	110,00
80	Nylon	★★★★	1	P-04438	0088381914277	111,00
80	Nylon	★★★★	1	794384-3	0088381139915	175,00
80	Nylon	★★	1	D-73592	0088381586122	43,00
100	Nylon	★★★★	1	794379-6	0088381140232	164,00
120	Nylon	★★★★	1	P-04444	0088381914284	111,00
180	Nylon	★★★★	1	P-04450	0088381914291	111,00
240	Nylon	★★★★	1	794383-5	0088381139908	167,00
320	Nylon	★★★★	1	P-04466	0088381914307	110,00

Rodillo para pulir de algodón



- Para pulir superficies, incluso con las cremas de pulido correspondientes para acero inoxidable, latón, etc.

Tipo	Unds.	Código	EAN	P.V.P. (€)
Algodón	1	794381-9	0088381139885	208,00

Rodillo abrasivo



- Para el pulido de superficies metálicas planas. Muy recomendado para acero inoxidable.

Grano	Tipo	Unds.	Código	EAN	P.V.P. (€)
80	Abrasivo	1	P-18035	0088381944410	62,00
120	Abrasivo	1	P-18041	0088381944427	62,00
180	Abrasivo	1	P-18029	0088381944403	62,00

Rodillo abrasivo con lijas



- Para pulido de superficies metálicas planas. Muy recomendado para acero inoxidable. Lija y pule al mismo tiempo.

Grano	Tipo	Unds.	Código	EAN	P.V.P. (€)
80	Abrasivo	1	P-18057	0088381944434	68,00
120	Abrasivo	1	P-19233	0088381945844	68,00
180	Abrasivo	1	P-19249	0088381945851	68,00

Rodillo de lijas



- Para pulir superficies. Rascar pintura.

Grano	Tipo	Unds.	Código	EAN	P.V.P. (€)
40	Abrasivo	1	P-01127	0088381913904	65,00
80	Abrasivo	1	P-01155	0088381921596	65,00



Cuchillas HM y HSS ★★

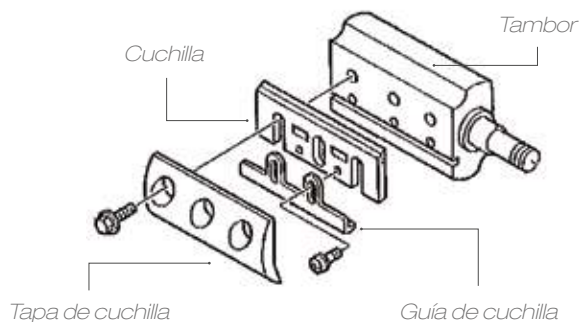

Modelo	Tipo	Longitud (mm)	Unds.	Código	EAN	P.V.P. (€)
1100 DKP180 DKP181 KP0800 KP0810 KP0810C	HSS	82	2	D-16346	0088381187756	7,30
	HM	82	2	D-07967	0088381181624	15,70
1911B	HSS	110	2	D-71211	0088381560160	15,30
	HSS	170	2	D-63666	0088381524070	27,00



Conjunto de mini-cuchillas + cuchillas HM / placas ★★

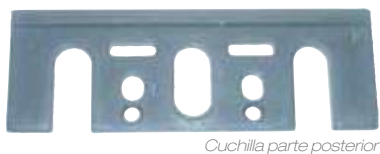

Cuchilla parte posterior

Modelos	Longitud (mm)	Detalle	Unds.	Código	EAN	P.V.P. (€)
1100 DKP180 DKP181 KP0800 KP0810 KP0810C	82	2+2	1	D-07951	0088381181617	13,30

Placa para mini-cuchillas



Modelos	Longitud (mm)	Unds.	Código	EAN	P.V.P. (€)
1100 DKP180 DKP181 KP0800 KP0810 KP0810C	82	1	343433-9	0088381151115	3,90

Mini-cuchillas

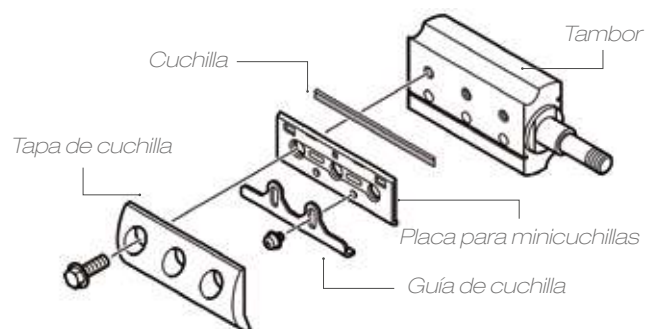

Modelo	Tipo	Longitud (mm)	Unds.	Código	EAN	P.V.P. (€)	
1050D 1051D	HM	50	2	A-85400	0088381148337	11,00	★★★
1100 DKP180 DKP181 KP0800 KP0810 KP0810C	HM	82	2	D-07945	0088381181600	11,90	★★
2012NB	HSS	304	2	793346-8	0088381101042	42,00	★★★
KP312S	HSS	312	2	B-02870	0088381125840	39,00	★★★

Set de minicuchillas 82mm ★★

- Blister que contiene 5 paquetes de 2 Unds. de mini-cuchillas código D-07945. Los conjuntos pueden ser fácilmente separados para la venta individual de cada uno de ellos.
- Válido para los cepillos de 82 mm.



Longitud (mm)	Tipo	Unds.	Código	EAN	P.V.P. (€)
82	HM	5	D-35302	0088381367646	44,00

Guías paralelas



Tipo A

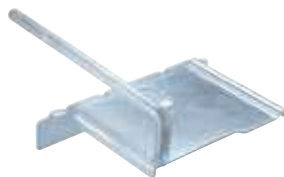

Tipo B



Tipo C

Modelo	Tipo	Unds.	Código	EAN	P.V.P. (€)
1100	A	1	161046-2	0088381122962	27,00
1902 1923B 1923H	B	1	165581-2	0088381361415	6,30
KP0800 DKP180	B	1	195055-9	0088381367110	10,60
KP0810 / C	C	1	122785-9	0088381346023	7,90
DKP181	C	1	191C23-8	0088381557429	31,00



Guía de profundidad



Modelos	Unds.	Código	EAN	P.V.P. (€)
KP0810 KP0810C KP0800 1923B 1923H	1	342390-8	0088381346412	2,20

Extensión para guías



Modelos	Unds.	Código	EAN	P.V.P. (€)
1923B 1923H KP0800 DKP180	1	191725-8	0088381126946	14,30

Mesa



Modelos	Unds.	Código	EAN	P.V.P. (€)
2012NB	1	193902-8	0088381186421	63,00

Guía achaflanar



Pueden colocarse dos guías de achaflanar.

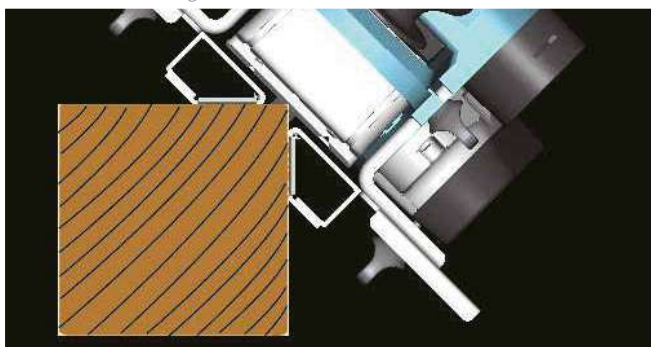

Modelos	Unds.	Código	EAN	P.V.P. (€)
KP0810 KP0810C	1	122791-4	0088381343190	29,00
DKP181	2	191C22-0	0088381557405	87,00

Adaptador de aspiración



Modelo	Diámetro de salida	Unds.	Código	EAN	P.V.P. (€)
2012NB	76 mm	1	193036-7	0088381154390	29,00



Calibrador de cuchillas



Modelos	Unds.	Código	EAN	P.V.P. (€)
1100 1923B KP0800 KP0810/C DKP180 DKP181	1	123062-2	0088381111270	3,05

Piedra de asentar el filo



Longitud total (mm)	Unds.	Código	EAN	P.V.P. (€)
150	1	794061-7	0088381110174	11,60
180	1	794060-9	0088381103176	13,80

Llave hexagonal



Forma	mm	Unds.	Código	EAN	P.V.P. (€)
L	4,0	1	783202-0	0088381102667	1,10
T	4,0	1	783219-3	0088381369985	2,80
L	2,5	1	783208-8	0088381152624	1,10

Llave de tubo 9



Modelos	Unds.	Código	EAN	P.V.P. (€)
1100 KP0800 1923B KP312S KP0810/C	1	782209-3	0088381102568	2,25

Llave fija 8mm



Modelo	Unds.	Código	EAN	P.V.P. (€)
KP301	1	781213-9	0088381102520	2,20

Maestro de afilado

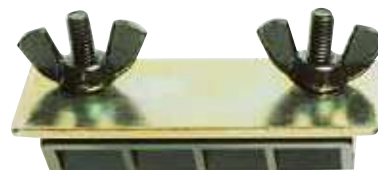

Modelos	Unds.	Código	EAN	P.V.P. (€)
1100 1923B KP0800 KP0810/C DKP180 DKP181	1	123004-6	0088381115391	3,30

Bolsa de polvo



Modelos	Unds.	Código	EAN	P.V.P. (€)
2012NB	1	STEX122312	0088381114974	68,00
KP0800 KP0810/C	1	122793-0	0088381346030	18,20
DKP181	1	191C21-2	0088381557450	31,00

Desviador de viruta



Modelos	Unds.	Código	EAN	P.V.P. (€)
1923H	1	122354-6	0088381114936	15,40
1100	1	415452-6	0088381142717	3,70
KP301	1	H311225	3240890101976	70,00
KP0800 KP0810/C	1	416368-8	0088381141703	2,20

Escuadra



Modelos	Unds.	Código	EAN	P.V.P. (€)
1806B 1923H KP312S	1	762001-3	0088381156912	0,85



Diamante

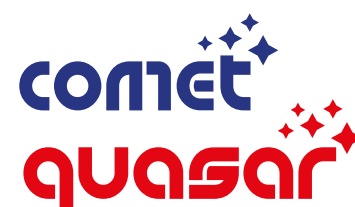

Protectores de disco para amoladoras.
Trabaja *sin polvo*. Cuida tu *salud*.



Discos de diamante



Discos de alta calidad para todo tipo de aplicaciones profesionales con la tecnología 3DDG de posicionamiento del diamante.

Tecnología STEALTH que utiliza 2 discos que hacen de molde sobre un núcleo de acero templado para reducir tanto las vibraciones como el ruido. Cortes más limpios y más rápidos.



30% MÁS DURACIÓN

50% MÁS RÁPIDO



La altura de los segmentos se incrementa hasta los 12mm.



Dientes en forma de M que habilitan un buen inicio del corte.



La tecnología 3D DiamondGrid es un avanzado método de fabricación del segmento que ordena los granos de diamante de forma paralela y uniforme por todo el segmento.

Soldadura láser que soporta grandes temperaturas.



Discos de diamante Quasar



Hormigón



Mármol
Terrazo



Ladrillo
medio/duro



Teja
cerámica



Pizarra
blanda

- Quasar con cuerpo compacto, más silencioso, soldadura láser, banda segmentada, baja vibración, larga duración y tecnología STEALTH.

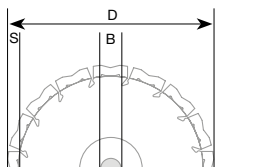

D (mm)	B (mm)	Reducción (mm)	S (mm)	Especificaciones	Unds.	Código	EAN	P.V.P. (€)
230	22,23	-	12	3DDG Stealth.	1	B-12712	0088381355452	148,00
300	20	-	12		1	B-13459	0088381359160	214,00
350	25,4	20	12		1	B-13465	0088381359177	276,00
400	25,4	20	12		1	B-13471	0088381359184	330,00



Discos de diamante



30% MÁS DURACIÓN

50% MÁS RÁPIDO

Aberturas de refrigeración para mantener el disco bien refrigerado durante el corte.

La altura de los segmentos se incrementa hasta los 10mm.

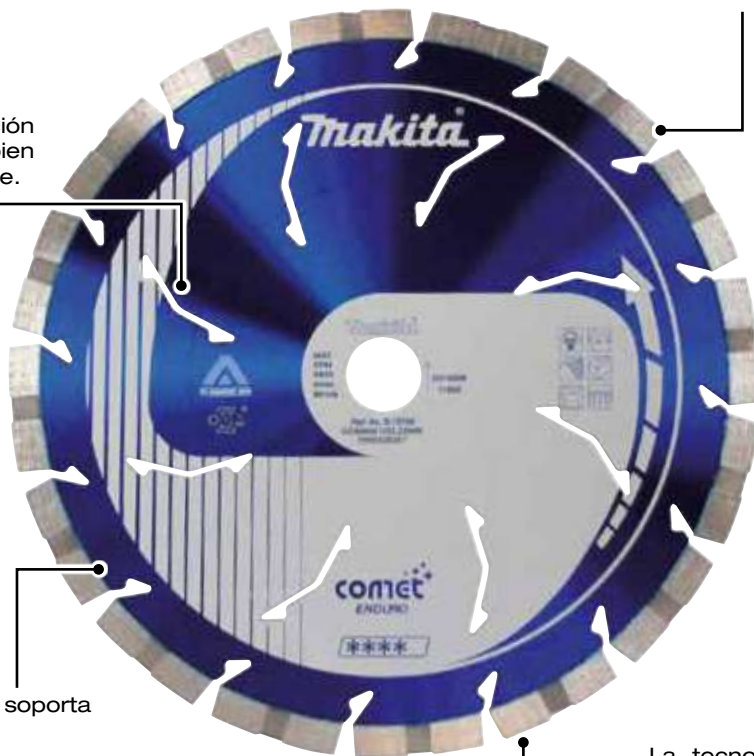

Dientes con rebaje en el centro que facilita la refrigeración.



Soldadura láser que soporta grandes temperaturas.

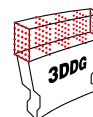

La tecnología 3D DiamondGrid es un avanzado método de fabricación del segmento que ordena los granos de diamante de forma paralela y uniforme por todo el segmento.



Discos de diamante COMET



- Cuerpo compacto, más silencioso.
- Con soldadura láser.
- Baja vibración.



Hormigón



Mármol Terrazo



Ladrillo medio/duro



Teja cerámica



Pizarra blanda

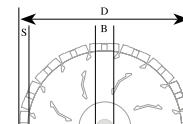
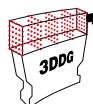

D (mm)	B (mm)	Reducción (mm)	S (mm)	Especificaciones	Unds.	Código	EAN	P.V.P. (€)
115	22,23	-	10	Aberturas de refrigeración	1	B-12762	0088381355506	48,00
125	22,23	20	10		1	B-12778	0088381355513	49,00
230	22,23	-	10	3DDG Aberturas de refrigeración Centro reforzado	1	B-12784	0088381355520	111,00
300	20	-	10		1	B-13546	0088381359252	166,00
350	25,4	20	10		1	B-13552	0088381359269	197,00
400	25,4	20	10		1	B-13568	0088381359276	238,00

Discos de diamante COMET banda turbo



- Disco con banda turbo con el que obtenemos un buen acabado de la pieza de trabajo.
- Aberturas de refrigeración que evita dilataciones en el disco.
- Con soldadura láser para soportar altas temperaturas.

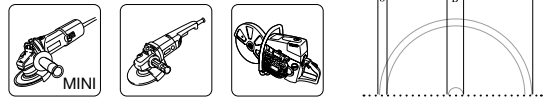

D (mm)	B (mm)	Reducción (mm)	S (mm)	Especificaciones	Unds.	Código	EAN	P.V.P. (€)
115	22,23	-	7	Banda turbo Núcleo estándar	1	B-12980	0088381358170	44,00
125	22,23	20	7		1	B-12996	0088381358187	49,00
150	22,23	20	7		1	B-13007	0088381358194	60,00
230	22,23	-	8		1	B-13035	0088381358224	97,00
300	25,4	-	8,5		1	B-13041	0088381358231	180,00
350	25,4	-	8,5		1	B-13057	0088381358248	235,00

Discos de diamante COMET banda continua



- Perfecto acabado en los materiales más duros.
- Se recomienda trabajar con agua para su buena refrigeración.
- Soldadura láser para soportar altas temperaturas.

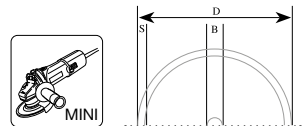

D (mm)	B (mm)	Reducción (mm)	S (mm)	Especificaciones	Unds.	Código	EAN	P.V.P. (€)
80	15	-	5	Banda continua Núcleo estándar	1	B-13063	0088381358255	76,00
115	22,23	-	5		1	B-13085	0088381358279	29,00
125	22,23	-	5		1	B-13091	0088381358286	31,00

Discos de diamante COMET banda continua electrodepositada



- Disco de banda continua con el diamante electrodepositado especial para materiales muy compactos y que necesiten un corte muy limpio para evitar roturas.

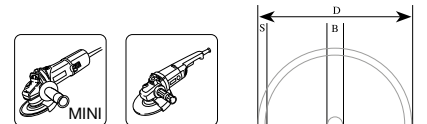

D (mm)	B (mm)	Reducción (mm)	S (mm)	Especificaciones	Unds.	Código	EAN	P.V.P. (€)
115	22,23	-	-	Electrodepositado Núcleo estándar	1	B-13172	0088381358378	58,00
125	22,23	20	-		1	B-13188	0088381358385	59,00
150	22,23	20	-		1	B-13194	0088381358392	79,00
230	22,23	-	-		1	B-13219	0088381358415	154,00
250	22,23	-	-		1	B-13225	0088381358422	281,00

Discos de diamante COMET especial juntas



- Diseño perfecto para en mortero, así como en materiales muy abrasivos.
- Para uso en mortero y ladrillo blando.
- Aberturas de refrigeración de gran tamaño.

• **Espesor 6,5mm**

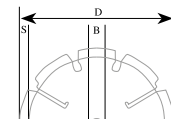

D (mm)	B (mm)	Reducción (mm)	S (mm)	Especificaciones	Unds.	Código	EAN	P.V.P. (€)
125	22,23	-	6,5	-	1	B-13253	0088381358453	103,00

Discos de diamante COMET especial asfalto



- Disco especial para trabajar en asfalto.
- Disco con pastilla de diamante de gran dureza ya que el asfalto es muy abrasivo.
- Banda segmentada para su refrigeración, pero se recomienda utilizar con cortadores de gasolina que tengan refrigeración con agua para una buena duración del disco.



Asfalto



Bloque



Arenisca dura



Ladrillo blando

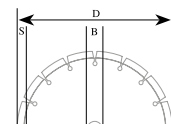

D (mm)	B (mm)	Reducción (mm)	S (mm)	Especificaciones	Unds.	Código	EAN	P.V.P. (€)
300	20	-	10	Asfalto Núcleo estándar	1	B-13269	0088381358460	185,00
350	25,4	20	10		1	B-13275	0088381358477	216,00

Discos de diamante NEBULA



- Discos de diamante de calidad estándar.
- Pro Segment / Laser Welding: reduce el sobrecalentamiento y ofrece una vida útil más larga.
- Para cortar hormigón, hormigón armado, ladrillo, piedra caliza y arenisca.

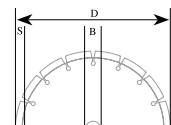

D (mm)	B (mm)	Reducción (mm)	S (mm)	Especificaciones	Unds.	Código	EAN	P.V.P. (€)
115	22,23	-	10	Soldadura láser	1	B-53986	0088381476485	25,00
125	22,23	-	10		1	B-53992	0088381476492	27,00
230	22,23	-	10		1	B-54025	0088381476522	35,00
300	20	-	10		1	B-54031	0088381476539	62,00
350	25,4	20	10		1	B-54053	0088381476553	79,00
400	25,4	20	10		1	B-54069	0088381476560	102,00



- Discos de uso general para el corte de todo tipo de materiales de obra.
- Apropiado para los materiales de mampostería.

Discos de diamante DIAMAK banda segmentada

- Gama económica de discos para trabajos generales de obra. Puede ser utilizado tanto en cortes secos como en húmedos. Disponible en banda segmentada, turbo y banda continua.
- Todo tipo de mampostería, bloque, ladrillo, pizarra y piedra caliza.

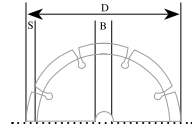

D (mm)	B (mm)	Reducción (mm)	S (mm)	Especificaciones	Unds.	Código	EAN	P.V.P. (€)	
115	22,23	-	7	Banda segmentada Núcleo estándar	1	D-61123	0088381475778	8,70	▼
125	22,23	-	7		1	D-52766	0088381445177	8,70	▼
150	22,23	-	7		1	B-06432	0088381276122	22,00	▼▼▼
230	22,23	-	7		1	D-61145	0088381475792	18,70	▼
300	25,40	-	7,5		1	D-56982	0088381458085	67,00	▼▼
350	25,40	-	7,5		1	D-56998	0088381458092	83,00	▼▼
400	25,40	-	7,5		1	D-57009	0088381458108	97,00	▼▼



- Nuevo expositor de cartón. Incluye 10 unds.



125	22,23	-	7	Banda segmentada Núcleo estándar	10	D-41595-10	0088381435376	88,00	
-----	-------	---	---	-------------------------------------	----	------------	---------------	-------	--

Discos de diamante DIAMAK banda turbo

- Para materiales duros, granito, materiales arcillosos, pizarra, piedra caliza y hormigón duro.
- Banda segmentada.
- Núcleo estándar.

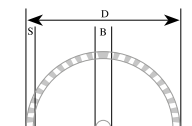

D (mm)	B (mm)	Reducción (mm)	S (mm)	Especificaciones	Unds.	Código	EAN	P.V.P. (€)	
115	22,23	-	7	Banda segmentada Núcleo estándar	1	D-61151	0088381475808	8,70	
125	22,23	20	7		1	D-61167	0088381475815	10,00	
230	22,23	-	7		1	D-61173	0088381475822	22,00	

Discos de diamante DIAMAK banda continua

- Para materiales duros, granito, materiales arcillosos, pizarra, piedra caliza y hormigón duro.

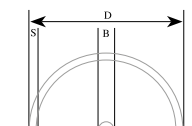

D (mm)	B (mm)	Reducción (mm)	S (mm)	Especificaciones	Unds.	Código	EAN	P.V.P. (€)	
110	22,23	-	7	Banda continua Núcleo estándar	1	D-61189	0088381475839	7,50	



Disco de diamante especial para herramientas a batería



- Nuevo disco de diamante de 230 mm ideal para cortadores a batería.
- Con este disco conseguimos aumentar la velocidad de corte y la vida útil del mismo.
- Para conseguir ranuras más estrechas, diseñamos el segmento en forma de abanico, obteniendo un mejor rendimiento de trabajo. Los diamantes se distribuyen regularmente en la estructura del segmento, así se logra un rendimiento de trabajo estable y reduce el consumo de batería.

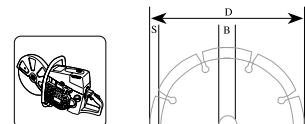

D (mm)	B (mm)	Reducción (mm)	S (mm)	Especificaciones	Unds.	Código	EAN	P.V.P. (€)
230	22,23	-	7	especial para DCE090	1	E-02967	0088381475792	149,00
355	25,4	-	8	CE001	1	E-12996	0088381590099	166,00



Discos de diamante X-LOCK



- Disco de diamante segmentado X-LOCK 115x22,23 mm.
- Los discos de diamante compatibles con las amoladoras X-LOCK permiten una instalación de disco fácil y segura.

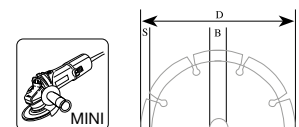

D (mm)	B (mm)	Reducción (mm)	S (mm)	Especificaciones	Unds.	Código	EAN	P.V.P. (€)
115	22,23	-	7	Compatible con amoladoras X-LOCK	1	E-02060	0088381556217	40,00
125	22,23	-	7		1	E-02076	0088381556224	43,00

Discos de diamante especial vidrio y porcelánico



- Segmentos continuos para un corte limpio sin rotura de las aristas de corte de azulejos, cerámica, mármol, vidrio, etc.



D (mm)	B (mm)	Modelo	Unds.	Código	EAN	P.V.P. (€)
85	15	CC301D	1	B-21098	0088381399777	37,00

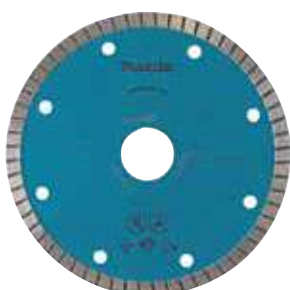

- Segmento continuo e inclinado de anchura extra fina de 1,2 mm para el corte rápido y limpio de azulejos, mármol y vidrio.



D (mm)	B (mm)	Modelo	Unds.	Código	EAN	P.V.P. (€)
110	20	4101RH	1	B-22028	0088381401760	101,00



- Perfecto acabado en los materiales más duros. Se recomienda trabajar con agua para su buena refrigeración. Soldadura láser para soportar altas temperaturas. Indicado para hormigón y porcelánico (no válido para vidrio).



D (mm)	B (mm)	Modelo	Unds.	Código	EAN	P.V.P. (€)
125	20	4101RH	1	B-21951	0088381401692	40,00



- Especial porcelánico.
- Disco extrafino, ideal para máquinas a batería.
- 1,4 mm.



D (mm)	B (mm)	Modelo	Unds.	Código	EAN	P.V.P. (€)
115	22,23	Amoladoras 115 mm	1	B-46327	0088381452403	39,00



- Especial porcelánico.
- Disco extrafino, ideal para máquinas a batería.
- 1,4 mm.



D (mm)	B (mm)	Modelo	Unds.	Código	EAN	P.V.P. (€)
125	22,23	Amoladoras 125 mm	1	B-46333	0088381452410	42,00



Discos de diamante especial rescate multimaterial



B-55326

- Corta todo tipo de materiales: Metal, plástico, madera, cristal, ladrillo, fibrocemento, hormigón...
- Perfecto para operaciones de rescate.
- Muy utilizado en parques de bomberos.

D (mm)	B (mm)	Modelo	Unds.	Código	EAN	P.V.P. (€)
125	22,23	Amoladoras 125 mm	1	B-55310	0088381482035	56,00
230	22,23	Amoladoras 230 mm	1	B-55326	0088381482042	104,00
305	22,23	Amoladoras 305 mm	1	B-55332	0088381482059	187,00



Discos de diamante para pulir hormigón



B-12289

- Disco para limpiar y pulir superficies de hormigón y piedra natural con un acabado fino.



B-12295

- Disco para limpiar rápidamente capas gruesas de hormigón.

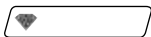

D-41464

- Gama económica.
- Disco para limpiar y pulir superficies de hormigón y piedra natural con un acabado fino.

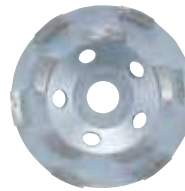

D-41458

- Gama económica.
- Disco para limpiar rápidamente capas gruesas de hormigón.

D (mm)	B (mm)	Modelo	Unds.	Código	EAN	P.V.P. (€)
125	22,23	PC5010C	1	B-12289	0088381354042	225,00
125	22,23	PC5010C	1	B-12295	0088381354059	110,00
125	22,23	PC5010C	1	D-41464	0088381404280	66,00
125	22,23	PC5010C	1	D-41458	0088381404273	58,00

Corte en seco - DBM130

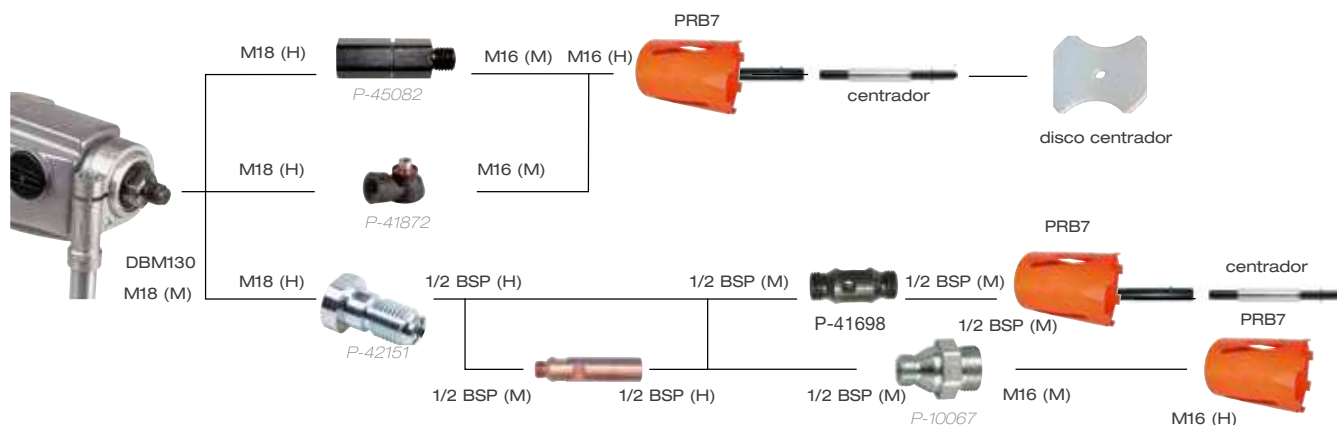

Brocas de corona de diamante para seco PRB7

- Brocas de diamante para todo tipo de mampostería.
- Para usar con martillos SDS-PLUS.

Brocas de corona de diamante para seco DB4

- Brocas de diamante para granito, mármol, ladrillo duro y otros materiales abrasivos.

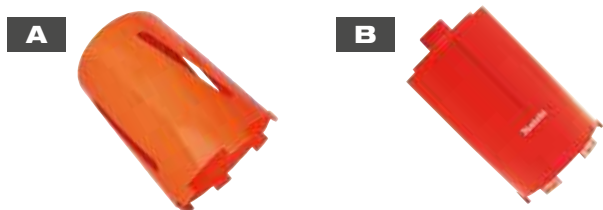

Tipo	Ø (mm)	Longitud (mm)	Inserción	Unds.	Código	EAN	P.V.P. (€)
A	22	300	1/2BSP (H)	1	P-57102	0088381987622	72,00
	28	300		1	P-57118	0088381987639	74,00
	32	150		1	P-57124	0088381987646	74,00
	38	150		1	P-57146	0088381987660	74,00
	48	150		1	P-57152	0088381987677	75,00
	65	150		1	P-57174	0088381987691	77,00
B	68	150	M16 (H)	1	P-63806	0088381994323	104,00
	132	150		1	P-63921	0088381994446	177,00

Ø (mm)	Longitud (mm)	Inserción	Unds.	Código	EAN	P.V.P. (€)
22	300	1/2BSP (H)	1	P-64060	0088381994583	42,00
28	300		1	P-64076	0088381994590	44,00
32	150		1	P-64082	0088381994606	46,00
38	150		1	P-64098	0088381994613	46,00
48	150		1	P-64107	0088381994620	50,00
52	150		1	P-64113	0088381994637	51,00
65	150		1	P-64129	0088381994644	52,00

- Para usar con martillos SDS-PLUS incluir adaptador para taladros de diamante página 169.

Prolongadores para brocas de corona



Longitud (mm)	Inserción	Unds.	Código	EAN	P.V.P. (€)
100	5/4 UNC	1	P-41604	0088381968614	36,00
200		1	P-41610	0088381968621	42,00
300		1	P-41626	0088381968638	52,00
400		1	P-41632	0088381968645	67,00
500		1	P-41648	0088381968652	85,00
100	1/2 BSP	1	P-41551	0088381968560	26,00
300		1	P-34718	0088381963879	26,00

Centradores



Tipo	Medida	Unds.	Código	EAN	P.V.P. (€)
A	60(punta)	1	P-41888	0088381968294	27,00
B	340 (para punta)	1	P-41903	0088381968317	79,00
C	170	1	P-34724	0088381963886	18,70

Adaptadores para taladros de diamante



Máquina	Broca	Unds.	Código	EAN	P.V.P. (€)
5/4 UNC (F)	1/2 BSP (F)	1	P-41676	0088381968683	52,00
1/2 BSP (M)	5/4 UNC (M)	1	P-41682	0088381968690	51,00
1/2 BSP (M)	1/2 BSP (M)	1	P-41698	0088381968706	42,00
1/2 BSP (M)	M16(M)	1	P-10067	0088381931083	16,80
1/2 BSP (M)	M30(M)	1	P-10073	0088381931090	17,70
HI	1/2 BSP (F)	1	P-41707	0088381968713	48,00
M18(F) - 5/4 UNC (M)	1/2 BSP (F)	1	P-42151	0088381970020	35,00
M18(F)	M30(M)	1	P-41866	0088381968270	20,00
M18(F)	M16(M)	1	P-45082	0088381975193	37,00
SDS-PLUS	1/2 BSP (M)	1	P-30031	0088381958196	22,00
SDS-PLUS	M16(M)	1	P-67745	0088381998277	22,00

Disco centrador (para utilizar con centrador)



Medida	Unds.	Código	EAN	P.V.P. (€)
68	1	P-41919	0088381968324	3,60
82	1	P-41931	0088381968348	5,20
132	1	P-41981	0088381968393	11,60

Adaptador de aspiración



* Para trabajos en seco con DBM130 ó DBM131.

Rosca (máquina)	Rosca (broca)	Unds.	Código	EAN	P.V.P. (€)
De M18 x 2,5	M16x2,0	1	P-41872	0088381968287	143,00

Brocas de corona para amoladora (especial mármol)



- Perforación más rápida.
- Sencilla obtención del punto de taladrado basculando la máquina.
- Válidas para trabajar en mármol y granito.
- Sólo utilizar en seco.

Ø (mm)	Medida	Unds.	Código	EAN	P.V.P. (€)
25	M14	1	D-35025	-	23,00
30	M14	1	D-35019	-	27,00
35	M14	1	D-35003	0088381360272	28,00

Brocas especiales para amoladora (especial porcelánico)



D-44507

D-61070

Ø (mm)	Medida	Unds.	Código	EAN	P.V.P. (€)
6	M14	1	D-61070	0088381475532	18,60
8	M14	1	D-61086	0088381475549	19,20
10	M14	1	D-61092	0088381475556	20,00
12	M14	1	D-61101	0088381475563	28,00
14	M14	1	D-44432	0088381406758	39,00
20	M14	1	D-44454	0088381406772	30,00
25	M14	1	D-44476	0088381406796	37,00
32	M14	1	D-44507	0088381406826	47,00
38	M14	1	D-44529	0088381406840	59,00
60	M14	1	D-44585	0088381406901	82,00
65	M14	1	D-44591	0088381406918	89,00
68	M14	1	D-44616	0088381406932	94,00
75	M14	1	D-44638	0088381406956	104,00

NOVEDAD

Kit de recuperación de agua y de vacío



[1] sólo membrana

P-54178

P-54221

Descripción	Unds.	Código	EAN	P.V.P. (€)
[1] Membrana	1	P-54184	0088381984690	30,00
Kit recuperación de agua	1	P-54178	0088381984683	210,00
Kit fijación vacío	1	P-54221	0088381984737	104,00

Soporte para DBM131 y DBM130



Descripción	Unds.	Código	EAN	P.V.P. (€)
Soporte	1	P-40082	0088381967952	771,00

Soporte para DBM230



*Kit de anclaje igual que DBM131.

Descripción	Unds.	Código	EAN	P.V.P. (€)
Soporte	1	P-54190	0088381984706	1.417,00

Kit de anclaje para DBM131, DBM130 y DBM230

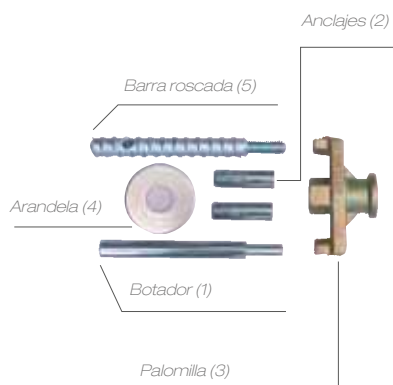

P-40098

Descripción	Unds.	Código	EAN	P.V.P. (€)
Kit fijación	1	P-40098	0088381967969	37,00
Botador (1)	1	P-40288	0088381968157	13,20
Anclajes (2)	1	P-40107	0088381967976	1,95
Palomilla (3)	1	P-40113	0088381967983	10,20
Arandela (4)	1	P-40129	0088381967990	4,70
Barra roscada (5)	1	P-41735	0088381968744	13,20

Accesorios para PW5000CH



Discos pulidores de diamante



- Discos pulidores de 100 mm para el perfecto pulido de la piedra.
- Fijación a la base por velcro.

Grano	Ø (mm)	Tipo	Color	Unds.	Código	EAN	P.V.P. (€)
50	100	Velcro	Azul	1	D-15584	0088381186759	15,90
200			Naranja	1	D-15609	0088381186773	15,90
800			Verde oscuro	1	D-15621	0088381186797	15,90
3.000			Marrón	1	D-15643	0088381186810	15,90
PIEL			Verde	1	D-15659	0088381186827	26,00

Plato de velcro



Ø (mm)	Tipo	Unds.	Código	EAN	P.V.P. (€)
100	Velcro	1	743080-0	0088381201223	27,00

Abrasivos amoladora



Alto Rendimiento Comparable con un modelo eléctrico



Equipadas con control automático de velocidad.

ADT

Cambia automáticamente la velocidad de corte ajustándose a la carga de trabajo para una operación óptima.

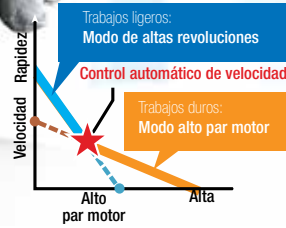

Función inteligente para minimizar el retroceso.

AFT

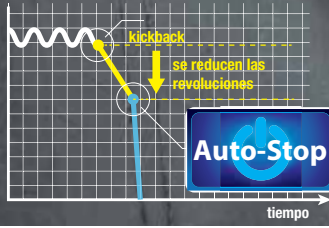

Apaga la herramienta para proteger al usuario, si la velocidad de rotación se desacelera repentinamente (por ejemplo, kick-back).

XLOCK

Nuevos discos para miniamoladoras 18V 115/125mm con sistema XLOCK. Permite cambiar el disco rápidamente, sin herramientas y sin esfuerzo.



XGT

Modelos			R.P.M.	Gatillo	AWS	BL MOTOR	AFT	ADT	XPT	BRAKE	SAR	XLOCK
115mm	125mm	150mm										
-	GA005G	GA035G	8.500	Interruptor	-	✓	✓	-	✓	✓	✓	-
-	GA013G	GA036G	8.500	Palanca	-	✓	✓	-	✓	✓	✓	-
GA022G	GA023G	-	3.000-8.500	Interruptor	✓	✓	✓	-	✓	✓	✓	-
GA028G	GA029G	-	3.000-8.500	Palanca	✓	✓	✓	-	✓	✓	✓	-
-	GA041G GA044G	-	3.000-8.500	Interruptor	✓	✓	✓	-	✓	✓	✓	✓

LXT

Li-Ion EXTREMA TECNOLOGIA

Modelos			R.P.M.	Gatillo	AWS	BL MOTOR	AFT	ADT	XPT	BRAKE	SAR	XLOCK
115mm	125mm	150mm										
DGA463	DGA513	-	3.000-8.500	Interruptor	-	✓	✓	✓	✓	✓	✓	-
DGA461	DGA511	-	3.000-8.500	Interruptor	-	✓	✓	✓	✓	-	✓	-
DGA454	DGA504	-	8.500	Interruptor	-	✓	✓	✓	✓	-	✓	-
DGA452	-	-	11.000	Interruptor	-	-	-	-	-	-	✓	-
-	DGA518	-	3.000-8.500	Palanca	✓	✓	✓	✓	✓	✓	✓	-
DGA467	DGA517	-	3.000-8.500	Palanca	-	✓	✓	✓	✓	✓	✓	-
DGA469	DGA519	-	3.000-8.500	Palanca	-	✓	✓	✓	✓	✓	✓	✓
DGA458	DGA508	-	8.500	Palanca	-	✓	✓	✓	✓	✓	✓	-

Discos abrasivos de desbarbe ★★★★★



Material	Ø ext. (mm)	Ø int. (mm)	Espesor (mm)	Unds.	Código	EAN	P.V.P. (€)
Metal	115	22,23	6,4	1	P-52978	0088381983488	1,65
Metal	125	22,23	6,4	1	P-52984	0088381983495	1,95
Metal	150	22,23	6,4	1	P-52990	0088381983501	2,80
Metal	180	22,23	7	1	P-52227	0088381982733	3,30
Metal	230	22,23	7	1	P-52819	0088381983327	4,70



Discos abrasivos de desbarbe ★★



Material	Ø ext. (mm)	Ø int. (mm)	Espesor (mm)	Unds.	Código	EAN	P.V.P. (€)
Metal	115	22,23	6	20	D-18459-20	0088381583992	27,00
Metal	125	22,23	6	20	D-18465-20	0088381584005	32,00

Discos abrasivos de desbarbe ★



Material	Ø ext. (mm)	Ø int. (mm)	Espesor (mm)	Unds.	Código	EAN	P.V.P. (€)
Metal	115	22,23	6	1	D-74485	0088381587709	1,05
Metal	125	22,23	6	1	D-74491	0088381587716	1,35
Metal	230	22,23	6	1	D-74522	0088381587747	3,20

Discos abrasivos de desbarbe para metal especial industria pesada ★★★★★



Material	Ø ext. (mm)	Ø int. (mm)	Espesor (mm)	Unds.	Código	EAN	P.V.P. (€)
Inox	115	22,23	7,2	1	B-56378	0088381490061	3,90
Inox	125	22,23	7,2	1	B-56390	0088381490085	4,40

Discos abrasivos de corte



Material	Ø ext. (mm)	Ø int. (mm)	Espesor (mm)	Unds.	Código	EAN	P.V.P. (€)
Metal A	115	22,23	3,2	1	P-52174	0088381982689	1,20
	125	22,23	3,2	1	P-52180	0088381982696	1,40
	150	22,23	3,2	1	P-52928	0088381983433	1,95
	180	22,23	3,2	1	P-52934	0088381983440	1,95
	230	22,23	3,2	1	P-52196	0088381982702	2,55
Piedra B	115	22,23	3,2	1	P-52205	0088381982719	1,40
	125	22,23	3,2	1	P-52940	0088381983457	1,65
	180	22,23	3,2	1	P-52962	0088381983471	2,20
	230	22,23	3,2	1	P-52211	0088381982726	3,05
Metal C	300	25,4	3	1	P-53148	0088381983655	4,10
	350	25,4	3	1	P-53154	0088381983662	5,50
	400	20	4	1	724409-9	-	46,00
Piedra D	300	20	3,2	1	721710-3	-	16,50
	350	25,4	4	1	721715A3	-	25,00
	400	20	4,7	1	724406-5	-	46,00



Discos abrasivos de desbarbe

XLOCK



★★★

Material	Ø ext. (mm)	Ø int. (mm)	Espesor (mm)	Unds.	Código	EAN	P.V.P. (€)
Metal	115	22,23	6	1	E-00365	0088381555395	1,85
Metal	125	22,23	6	1	E-00393	0088381555425	2,20
Inox	115	22,23	6	1	E-00371	0088381555401	2,40
Inox	125	22,23	6	1	E-00402	0088381555432	3,00

Discos abrasivos extrafinos de corte

XLOCK



★★★

Material	Ø ext. (mm)	Ø int. (mm)	Espesor (mm)	Unds.	Código	EAN	P.V.P. (€)
Metal	115	22,23	1,2	1	E-00387	0088381555418	2,00
Metal	125	22,23	1,2	1	E-00418	0088381555449	2,20

Discos abrasivos extrafinos de corte



★★★★

Material	Ø ext. (mm)	Ø int. (mm)	Espesor (mm)	Unds.	Código	EAN	P.V.P. (€)
Metal A	115	22,23	1	1	P-53001	0088381983518	1,40
	115	22,23	1,6	1	P-53017	0088381983525	1,40
	125	22,23	1	1	P-53023	0088381983532	1,45
	125	22,23	1,6	1	P-53039	0088381983549	1,45
	230	22,23	2	1	P-52233	0088381982740	3,30
Inox B	115	22,23	1	1	P-52249	0088381982757	1,40
	115	22,23	1,6	1	P-52255	0088381982764	1,40
	125	22,23	1	1	P-53045	0088381983556	1,40
	125	22,23	1,6	1	P-53051	0088381983563	1,45
Piedra C	230	22,23	2	1	P-53067	0088381983570	3,30
	115	22,23	1	1	P-53073	0088381983587	1,40
	115	22,23	1,6	1	P-53089	0088381983594	1,95
Aluminio D	125	22,23	1	1	P-53095	0088381983600	1,45
Aluminio D	115	22,23	1,6	1	P-53126	0088381983631	1,40

Paquetes de discos de corte fino

★★

★★★★



Material	Ø ext. (mm)	Ø int. (mm)	Espesor (mm)	Unds.	Código	EAN	P.V.P. (€)
Inox	115	22,23	1	10	D-65953-10	0088381561815	7,40
Inox	125	22,23	1	10	D-65969-10	0088381561822	8,50
Inox	115	22,23	0,8	12	E-10861-12	0088381581424	21,00
Inox	125	22,23	0,8	12	E-10877-12	0088381581455	24,00

Discos abrasivos extrafinos de corte



Material	Ø ext. (mm)	Ø int. (mm)	Espesor (mm)	Unds.	Código	EAN	P.V.P. (€)
Metal	115	22,23	1	1	D-75524	0088381595285	1,05
	125	22,23	1	1	D-75530	0088381595292	1,05
	230	22,23	2	1	D-75568	0088381595322	2,10

Disco abrasivo para DCE090

★★★

- Para corte rápido.
- Produce menos polvo y rebaba de los materiales.



Material	Ø ext. (mm)	Ø int. (mm)	Espesor (mm)	Unds.	Código	EAN	P.V.P. (€)
Inox	230	22,23	2	25	E-03006-25	0088381567442	61,00

XLOCK

Discos abrasivos multimaterial

- El disco de corte de espesor delgado, se adapta a múltiples materiales.
- Son adecuados para usar en construcción, fontanería, etc.



Material	Ø ext. (mm)	Ø int. (mm)	Espesor (mm)	Unds.	Código	EAN	P.V.P. (€)
Multi material	115	22,23	1,2	1	E-10718	0088381580526	1,65
Multi material	125	22,23	1,2	1	E-10724	0088381580533	1,95



Discos abrasivos para cortadores



Material	Ø ext. (mm)	Ø int. (mm)	Espesor (mm)	Unds.	Código	EAN	P.V.P. (€)
Metal	355	25,4	3	5	B-10665-5	0088381348058	22,00
Aluminio	355	25,4	2,8	5	E-04977-5	-	42,00
Metal	355	25,4	3	5	E-12790-5	0088381589826	68,00

★★★

★★★★



Piedras de amolar

★★★★



B-28662

B-28678

B-51976



B-51960

B-51954

B-51910

No ferroso
Inox
Metal

No ferroso
Inox
Metal

Grano	Ø ext. (mm)	Ø int. (mm)	Espesor (mm)	Unds.	Código	EAN	P.V.P. (€)
Para GS5000							
24	125	20	20	1	B-28662	0088381414890	61,00
36	125	20	20	1	B-28678	0088381414906	61,00
Para GS6000							
24	150	20	20	1	B-28684	0088381414913	77,00
36	150	20	20	1	B-28690	0088381414920	77,00
Para GB801							
120	205	15,88	19	1	B-51976	0088381467490	30,00
60	205	15,88	19	1	B-51960	0088381467483	24,00
60	205	15,88	19	1	B-51954	0088381467476	22,00
Para GB602							
120	150	12,7	16	1	B-51932	0088381467452	16,50
60	150	1,7	16	1	B-51926	0088381467445	14,80
60	150	12,7	16	1	B-51910	0088381467438	13,10



Nuevas

Discos de láminas

- Para desbarbar, desoxidar, limpiar o rebajar los cordones de soldadura en metales, aluminio y otras aleaciones.
- También podemos aplicarlos en trabajos de carpintería, decapado de muebles, lijado de masillas, trabajos en vigas viejas etc...
- Cuerpo de fibra de vidrio: el más común dentro del mercado. Disco más económico que el de nylon, ofrece: Ligereza y flexibilidad.
- Cuerpo de nylon: para los trabajos de lijado más exigentes. Están indicados para lijados donde debemos ejercer gran presión sobre el material. Mayor rendimiento y mayor calidad.
- Forma del disco curvo: permite trabajos en superficie con forma. Ideal para el lijado de tubos así como cordones de soldadura.
- Forma del disco plano: perfecto para los trabajos en superficies planas, consiguiendo así un acabado más uniforme en este tipo de superficies.

Tabla de aplicación

Madera		★★★★			
Plástico		★★★★			
Metales		★★★★★	★★★★★	★★★★★	
Metales no férricos		★★★★	★★★★	★★★★	
Acero Inox			★★★★★	★★★★★	
Ladrillo, piedra, hormigón					★★★★★

Discos de láminas - Óxido de aluminio

- Discos con abrasivo de óxido de aluminio, válidos para gran variedad de materiales: metales férricos, no férricos, plásticos y madera.



Tipo Curvo



Cuerpo de fibra de vidrio

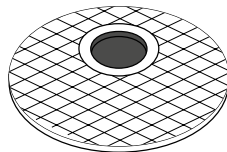

Materiales

- Metal
- Plástico
- Madera
- Metales no férricos

Ø ext. (mm)	Ø int. (mm)	Grano	R.p.m	Unds.	Código	EAN	P.V.P. (€)
115		40	13.290	1	D-27034	0088381343633	3,40
		60	13.290		D-27040	0088381343640	3,40
		80	13.290		D-27056	0088381343657	3,40
		120	13.290		D-27062	0088381343664	3,40
125	22,23	40	13.290	D-27084	0088381343688	3,90	
		60	13.290	D-27090	0088381343695	3,90	
		80	13.290	D-27109	0088381343701	3,90	
		120	13.290	D-27115	0088381343718	3,90	
180		40	8.600	D-27137	0088381343732	7,70	
		60	8.600	D-27143	0088381343749	7,70	
		80	8.600	D-27159	0088381343756	7,70	
		120	8.600	D-27165	0088381343763	7,70	

Discos de láminas - Óxido de aluminio cerámico



- Ideal para inoxidable, titanio, níquel y otros metales de gran densidad.
- La gama alta de los discos de láminas.



Tipo curvo



Cuerpo de fibra de vidrio

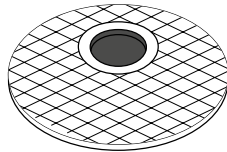

Materiales



Metal



Acero inoxidable



Metales no férricos

Ø ext. (mm)	Ø int. (mm)	Grano	R.p.m	Unds.	Código	EAN	P.V.P. (€)
180	22,23	40	8.600	1	D-28379	0088381344975	14,30
		60	8.600		D-28385	0088381344982	14,30
		80	8.600		D-28391	0088381344999	14,30
		120	8.600		D-28400	0088381345002	14,30

Discos de láminas - Carburo de silicio



- Discos con abrasivo de carburo de silicio muy efectivo en materiales como el ladrillo, piedra y hormigón.
- No es necesario trabajarlo con agua.



Tipo plano



Cuerpo de fibra de vidrio

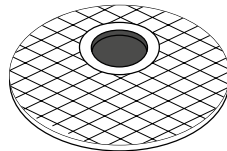

Materiales



Ladrillo, piedra y hormigón



Ø ext. (mm)	Ø int. (mm)	Grano	R.p.m	Unds.	Código	EAN	P.V.P. (€)
115	22,23	40	13.290	1	D-28036	0088381344630	4,00
		60	13.290		D-28042	0088381344647	4,00
		80	13.290		D-28058	0088381344654	4,00
		120	13.290		D-28064	0088381344661	4,00
125	22,23	40	13.290	1	D-28086	0088381344685	4,50
		60	13.290		D-28092	0088381344692	4,50
		80	13.290		D-28101	0088381344708	4,50
		120	13.290		D-28117	0088381344715	4,50
180	22,23	40	8.600	1	D-28139	0088381344739	7,70
		60	8.600		D-28145	0088381344746	7,70
		80	8.600		D-28151	0088381344753	7,70
		120	8.600		D-28167	0088381344760	7,70

- Discos de nylon para los trabajos más exigentes. Indicados para lijados donde debemos ejercer gran presión sobre el material, consiguiendo así un poder de lijado mayor. Mayor rendimiento y mayor calidad.



Tipo plano



Cuerpo de nylon

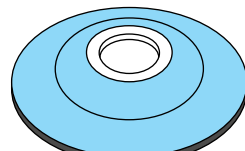

Materiales



Ø ext. (mm)	Ø int. (mm)	Grano	R.p.m	Unds.	Código	EAN	P.V.P. (€)
115	22,23	40	13.290	1	D-28173	0088381344777	5,50
		60	13.290		D-28189	0088381344784	5,50
		80	13.290		D-28195	0088381344791	5,50
		120	13.290		D-28204	0088381344807	5,50
180	22,23	40	8.600	1	D-28210	0088381344814	11,00
		60	8.600		D-28226	0088381344821	11,00
		80	8.600		D-28232	0088381344838	11,00
		120	8.600		D-28248	0088381344845	11,00



Discos de láminas - Zirconio



- Discos con abrasivo de Zirconio perfecto para los trabajos en metales y trabajos en acero inoxidable.
- “El disco más popular del mercado”.



Tipo curvo



Cuerpo de fibra de vidrio

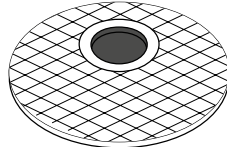

Materiales

- Metal
- Acero inoxidable
- Metales no férricos



- Los discos de nylon son ideales para los trabajos de lijado más exigentes. Están indicados para lijados donde debemos ejercer gran presión sobre el material, consiguiendo así un poder de lijado mayor que con cualquier otro disco.
- Ofrecen mayor rendimiento y mayor calidad. Mantienen las láminas hasta la terminación del abrasivo.



Tipo plano



Cuerpo de nylon

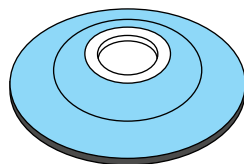

Materiales



Ø ext. (mm)	Ø int. (mm)	Grano	R.p.m	Unds.	Código	EAN	P.V.P. (€)
115	22,23	40	13.290	1	D-53724	0088381445320	3,10
		60	13.290		D-53730	0088381445337	3,10
		80	13.290		D-53746	0088381445344	3,10
		120	13.290		D-53752	0088381445351	3,10
180	22,23	40	8.600	1	D-53827	0088381445429	8,00
		60	8.600		D-53833	0088381445436	8,00
		80	8.600		D-53849	0088381445443	8,00
		120	8.600		D-53855	0088381445450	8,00

115	22,23	40	13.290	1	D-63747	0088381525350	2,00
		60	13.290		D-63753	0088381525367	2,00
		80	13.290		D-63769	0088381525374	2,00
		120	13.290		D-63775	0088381525381	2,00
125	22,23	40	13.290	1	D-63781	0088381525398	2,30
		60	13.290		D-63797	0088381525404	2,30
		80	13.290		D-63806	0088381525411	2,25
		120	13.290		D-63812	0088381525428	2,25
180	22,23	40	8.600	1	D-63828	0088381525435	4,50
		60	8.600		D-63834	0088381525442	4,50
		80	8.600		D-63840	0088381525459	4,50
		120	8.600		D-63856	0088381525466	4,50

Nuevos

115	22,23	40	13.290	1	D-74186	0088381587228	1,85
		60	13.290		D-74192	0088381587235	1,85
		80	13.290		D-74201	0088381587242	1,85
		120	13.290		D-74217	0088381587259	1,85
125	22,23	40	13.290	1	D-74223	0088381587266	2,15
		60	13.290		D-74239	0088381587273	2,15
		80	13.290		D-74245	0088381587280	2,15
		120	13.290		D-74251	0088381587297	2,15
180	22,23	40	8.600	1	D-74267	0088381587303	4,50
		60	8.600		D-74273	0088381587310	4,50
		80	8.600		D-74289	0088381587327	4,50
		120	8.600		D-74295	0088381587334	4,50

Ø ext. (mm)	Ø int. (mm)	Grano	R.p.m	Unds.	Código	EAN	P.V.P. (€)
115	22,23	40	13.290	1	D-27838	0088381344432	5,50
		60	13.290		D-27844	0088381344449	5,50
		80	13.290		D-27850	0088381344456	5,50
		120	13.290		D-27866	0088381344463	5,50
125	22,23	40	13.290	1	D-27888	0088381344487	6,60
		60	13.290		D-27894	0088381344494	6,60
		120	13.290		D-27919	0088381344517	6,60
		40	8.600		D-27931	0088381344531	11,00
180	22,23	60	8.600	1	D-27947	0088381344548	11,00
		80	8.600		D-27953	0088381344555	11,00
		120	8.600		D-27969	0088381344562	11,00

Discos abrasivos - Scotch

- Discos abrasivos de Scotch indicados para la limpieza de superficies metálicas, de acero inoxidable o de metales no ferrosos. También pueden ser utilizados en superficies pulidas de piedra.
- El acabado que conseguimos con estos discos es mejor que el conseguido con discos de láminas y discos de desbaste.
- Con este tipo de discos no es necesario realizar demasiada presión, obtenemos un buen lijado con poca fuerza, así conseguiremos un muy buen acabado y una mayor duración del disco.
- Para superficies irregulares como la chapa palillo son ideales gracias a la ligera flexibilidad de los discos.

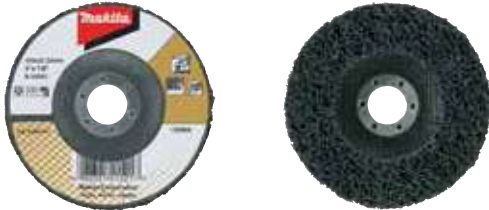

Ø ext. (mm)	Ø int. (mm)	Unds.	Código	EAN	P.V.P. (€)
115	22,23	1	B-28977	0088381415200	10,20
125	22,23	1	B-28983	0088381415217	11,30

Discos de láminas - Vellón

- Indicado para el pulido del metal. Perfecto para aceros fuertes y aleados resistentes a la corrosión.
- Contiene poco Fe, S y Cl, por lo que es resistente al óxido.
- Dependiendo del grosor de la fibra podemos desde eliminar rebaba hasta pulir.
- Cubierto por una resina de alúmina que permite trabajar más rápido y con menos potencia.
- Las fibras de vellón evitan la abrasión del material.



Las fibras de vellón finas y flexibles ofrecen un buen acabado de la superficie. Hasta el doble de duración que otros discos de vellón. Ideal para utilizar después de un disco abrasivo



Ø ext. (mm)	Ø int. (mm)	Grano	Unds.	Código	EAN	P.V.P. (€)
115	22,23	Grueso	1	B-40917	0088381439237	10,20
125		Grueso		B-40951	0088381439275	11,80
115		Medio		B-40923	0088381439244	10,20
125		Medio		B-40967	0088381439282	11,80
115		Fino		B-40939	0088381439251	10,20
125		Fino		B-40973	0088381439299	11,80
115		Super fino		B-40945	0088381439268	10,20
125		Super fino		B-40989	0088381439305	11,80



Aplicación

Pulido



Limpieza en cordones de soldadura



Pulido en óxido



Muelas TCT



Descripción			Ø (mm)	Longitud total	Longitud útil	Inserción	Tipo de grano	Tipo de corte	Aplicación	Código	EAN	P.V.P (€)
Muela TCT			10	45	20	6	SC	Diamante	Metal y acero Inox	B-52750	0088381470131	17,00
					20		SF			B-52788	0088381470193	17,00
					25		SL			B-52819	0088381470254	17,00
					20		SM			B-52847	0088381470315	17,00



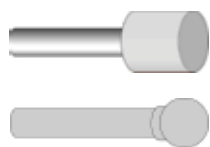



Muelas abrasivas



Modelo	Tipo de abrasivo	Inserción	Ø de la muela (mm)	Unds.	Código	EAN	P.V.P. (€)
GD0600 GD0601 GD0602 GD0603	A para acero medio	3	5	1	794050-2	008838110211	1,40
GD0800C GD0801C GD0810C GD0811C		3	6	1	794051-0	008838110228	1,40
		3	10	1	794053-6	008838110242	1,40
		3	10	1	794059-4	008838110303	3,05



Empuñaduras

Modelo	Descripción	Unds.		Código	EAN	P.V.P. (€)	
Para amoladoras de: 115 mm 125 mm 150 mm	Rígida	1		153489-2	0088381193054	1,20	
	Antivibración	1		162258-0	0088381343381	13,70	
Para amoladoras: 9015B 9016B Lijadora 9218SB	Rígida	1		152492-0	0088381131599	3,05	
Para amoladoras: 180 mm 230 mm	Antivibración	1		162264-5	0088381345828	16,10	
	De corte	1		194684-5	0088381349895	14,80	

Colectores de polvo

El polvo puede causar graves enfermedades respiratorias. Para tratar de evitarlas Makita recomienda utilizar colector de polvo con una tasa de aspiración hasta del 90% de las partículas. Carcasa en aluminio para una mayor duración. Posibilidad de bloquear el disco a la profundidad deseada. Visor con protector transparente.

Colector de polvo amoladoras 230 mm

Colector de polvo amoladoras 125 mm



Ø (mm)	Descripción	Unds.	Código	EAN	P.V.P. (€)
230	Aluminio. Posibilidad de bloquear el disco. Visor transparente.	1	198440-5	0088381487368	146,00



Ø (mm)	Descripción	Unds.	Código	EAN	P.V.P. (€)
125	Aluminio. Posibilidad de bloquear el disco. Visor transparente.	1	196845-3	0088381442527	81,00
125	Con enganche rápido sin herramientas*	1	191G06-2	0088381566001	87,00

* Para amoladoras con enganche rápido de disco.

Colectores de polvo aptos para amoladoras de 115 mm, 125 mm y 180 mm. Especial para su uso en lijados con discos de diamante en hormigón. Modelos de amoladoras compatibles: potencia 1.100W o superior. Alta capacidad de aspiración. Apta para rincones gracias a su sistema de dos piezas.

Modelos	Diámetro (mm)	Descripción	Unds.	Código	EAN	P.V.P. (€)
Amoladoras 115 / 125 mm X-LOCK.	115 / 125	Especial para su uso en lijados con discos.	1	191F81-2	0088381565479	52,00
Amoladoras 115 mm / 125 mm.	115 / 125		1	195239-9	0088381361804	52,00
Amoladoras 180 mm.	180		1	195385-8	0088381369381	71,00



Protectores de disco

Tipo estándar



Tornillo



Rápido

Modelos	Ø (mm)	Cierre	Unds.	Código	EAN	P.V.P. (€)
9557NBR	115	Tornillo	1	123098-1	0088381451383	7,70
9557NBRK1			1	123098-1	0088381451383	7,70
9557NBRX2			1	123098-1	0088381451383	7,70
9558NBR	125	Tornillo	1	123099-9	0088381451390	8,30
9558NBRK1			1	123099-9	0088381451390	8,30
9558PBY			1	123099-9	0088381451390	8,30
9565CR	125	Rápido	1	123145-8	0088381420181	9,70
9565CVR			1	123145-8	0088381420181	9,70
9565PCV			1	123145-8	0088381420181	9,70
9566PCV01	150	Tornillo	1	123146-6	0088381420198	12,10
GA4530R	115	Tornillo	1	123098-1	0088381451383	7,70
GA4534			1	123098-1	0088381451383	7,70
GA4540C		Rápido	1	123144-0	0088381420167	10,40
GA4540RZ	Tornillo	1	123098-1	0088381451383	7,70	
GA5021C	125	Rápido	1	123145-8	0088381420181	9,70
GA5030R		Tornillo	1	123099-9	0088381451390	8,30
GA5034		Tornillo	1	123099-9	0088381451390	8,30
GA5040C		Rápido	1	123145-8	0088381420181	9,70
GA5040C01		Rápido	1	123145-8	0088381420181	9,70
GA5040RZ		Tornillo	1	123099-9	0088381451390	8,30
GA6021C	150	Rápido	1	123146-6	0088381420198	12,10
GA6040C		Rápido	1	123146-6	0088381420198	12,10
GA7012C	180	Tornillo	1	122846-5	3240890337726	14,00
GA7020R		Tornillo	1	122889-7	0088381364447	9,60
GA7030R		Tornillo	1	122889-7	0088381364447	9,60
GA7040R		Tornillo	1	122889-7	0088381364447	9,60
GA7050		Tornillo	1	122889-7	0088381364447	9,60
GA7050R		Tornillo	1	122889-7	0088381364447	9,60
GA7060R		Tornillo	1	122889-7	0088381364447	9,60
GA7061R	Tornillo	1	122889-7	0088381364447	9,60	
GA9012C	230	Rápido	1	163411-1	0088381201155	32,00
GA9020R		Tornillo	1	122891-0	3240890337696	11,00
GA9020RKD		Tornillo	1	122891-0	3240890337696	11,00
GA9020SFYK		Tornillo	1	122891-0	3240890337696	11,00
GA9030R		Tornillo	1	122891-0	3240890337696	11,00
GA9040R		Tornillo	1	122891-0	3240890337696	11,00
GA9050		Tornillo	1	122891-0	3240890337696	11,00
GA9050R		Tornillo	1	122891-0	3240890337696	11,00
GA9060R		Tornillo	1	122891-0	3240890337696	11,00
GA9061R		Tornillo	1	122891-0	3240890337696	11,00

Tipo especial para corte con disco abrasivo



122913-6



199709-0



Ø (mm)	Cierre	Unds.	Código	EAN	P.V.P. (€)
125 mm	Tornillo	1	122911-0	0088381367134	8,90
230 mm		1	122913-6	0088381367141	17,40
115 mm	Para colocar sobre protector	1	199709-0	0088381544665	10,10
125 mm		1	199710-5	0088381544672	10,60

Arandela centradora y tuerca



224415-9



224543-0

Descripción	Tipo	Modelos	Unds.	Código	EAN	P.V.P. (€)
Arandela	M14	"Ø 115, Ø 125, Ø 150, Ø 180, Ø 230 mm."	1	224415-9	0088381348256	1,70
Tuerca	M14		1	224543-0	0088381116176	2,10

Tipo especial para limpieza con gratas



Ø (mm)	Cierre	Unds.	Código	EAN	P.V.P. (€)
60 - 75 mm	Tornillo	1	192454-6	0088381200912	42,00

Protector para amoladoras rectas



Modelos	Ø (mm)	Cierre	Unds.	Código	EAN	P.V.P. (€)
GS5000	125	Tornillo	1	123199-5	3240890390677	24,00
GS6000	150			123200-6		25,00

Tuerca de cierre rápido Ezynt



Descripción	Tipo	Modelos	Unds.	Código	EAN	P.V.P. (€)
Tuerca rápida	M14	Amoladoras 180mm y 230mm	1	195354-9	0088381367189	44,00

Super - Flange (autoapretante)



Descrip.	Tipo	Modelos	Unds.	Código	EAN	P.V.P. (€)
Arandela	M14	Todos los modelos	1	192227-7	008838117371	15,40
Tuerca	M14		1	125052-1	0088381155960	12,10

Set de filtros



Modelos	Unds.	Código	EAN	P.V.P. (€)
GA4550R GA5050R	1	199514-5	0088381586559	28,00
GA4540R GA4540C GA5040R GA5040C GA6040C SA5040C	1	198719-4	0088381534857	17,20
9565CR 9565CVR	1	193903-6	0088381187619	16,00
9565PCV	1	195446-4	0088381486057	12,10
GA7012C GA9012C GA5021C GA6021C	1	193956-5	0088381191982	9,10
GA7020R GA7030R GA7040R GA9020R GA9030R GA9040R	1	194289-1	0088381341950	2,20



Amoladoras angulares



Amoladoras rectas



Amoladoras rectas con discos



Casquillos cónicos para amoladoras rectas



Tuerca



Casquillo



Modelo	Ø (mm)	Descripción	Unds.	Código	EAN	P.V.P. (€)
GD0600 GD0601	3	Casquillo	1	763627-4	0088381114769	13,20
	6		1	763620-8	0088381114776	10,80
	6,35 (1/4")		1	763625-8	0088381102339	12,70
	-	Tuerca	1	763664-8	3240890340672	1,40
GD0602 DGD800	3	Casquillo	1	763669-8	0088381435925	18,20
	6		1	763670-3	0088381435932	9,10
	8		1	763671-1	0088381435949	18,20
	-	Tuerca	1	763668-0	0088381495714	1,65
GD0603	6	Casquillo	1	763620-8	0088381114776	10,80
	-	Tuerca	1	763236-9	0088381495684	3,15
GD0800C GD0801C GD0810C GD0811C	3	Casquillo + Tuerca	1	193011-3	0088381156394	25,00
	6		1	193012-1	0088381156400	20,00
	6,35 (1/4")		1	193143-6	0088381156363	25,00
	8	1	192988-9	0088381156387	26,00	
	6	Casquillo	1	763646-0	0088381170345	15,40
	-	Tuerca	1	763645-2	0088381170338	2,60



Soporte



Modelos	Unds.	Código	EAN	P.V.P. (€)
GD0800C GD0810C	1	193141-0	0088381156745	68,00

Empuñadura lateral



Modelos	Unds.	Código	EAN	P.V.P. (€)
GD0600C GD0601C GD0800C GD0810C	1	192985-5	0088381156417	15,00

Llaves para amoladoras rectas



Modelo	Medida (mm)	Unds.	Código	EAN	P.V.P. (€)
GD0602 GD0601 GD0600	13	1	781039-9	0088381290630	1,25
GD0800C GD0810C	19	1	781206-6	0088381124072	4,10
GD0800C GD0810C	13	1	781203-2	0088381102476	2,80

Llaves de pivotes



Modelos	Unds.	Código	EAN	P.V.P. (€)
115, 125 y 150mm	1	782423-1	0088381572323	1,70
180 - 230 mm	1	197610-3	0088381519007	2,30



Accesorios para cortadores

Grifo completo



Modelos	Unds.	Código	EAN	P.V.P. (€)
4101RH	1	153409-6	0088381201148	18,90

Tubo de vinilo



Modelos	Unds.	Código	EAN	P.V.P. (€)
4100NB 4101RH	1	412088-2	0088381538459	3,50

Guía lateral



Modelos	Unds.	Código	EAN	P.V.P. (€)
5604R 5704R 4100KB 4101RH N4105KB 4131	1	164095-8	0088381101080	1,95

Adaptador carril guía 4100KB



Interruptor de seguridad



Modelos	Unds.	Código	EAN	P.V.P. (€)
4101RH	1	652739-7	-	105,00



Modelos	Unds.	Código	EAN	P.V.P. (€)
4100KB	1	198673-2	0088381497374	27,00



Accesorios para PW5000CH

Protector de cabezal



Unds.	Código	EAN	P.V.P. (€)
1	417322-5	0088381156981	8,10

Empuñadura



Unds.	Código	EAN	P.V.P. (€)
1	153489-2	0088381193054	1,20



Accesorios para PC5001C

Bolsa de polvo



Unds.	Código	EAN	P.V.P. (€)
1	122853-8	0088381358637	5,20

Set cepillos



Unds.	Código	EAN	P.V.P. (€)
1	194921-7	0088381358675	8,20

Porta llave 5,6



Unds.	Código	EAN	P.V.P. (€)
1	410047-0	0088381123686	0,80



Casquillo reductor



Ø exterior (mm)	Ø interior (mm)	Unds.	Código	EAN	P.V.P. (€)
22,23	20	10	A-85248	0088381538596	9,40
25,4	20	1	197318-9	0088381234733	11,70



Set de filtros de aire

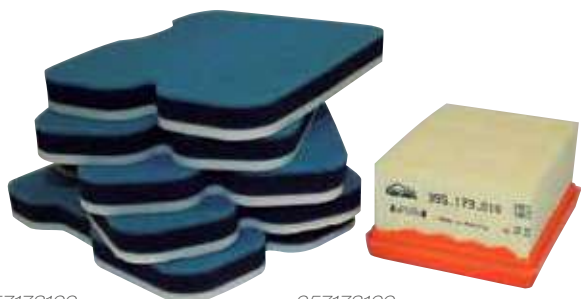

957173190

957173190

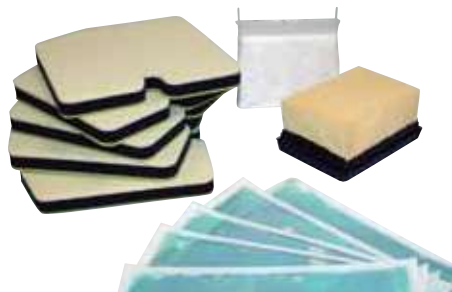

195599-9

Descripción	Modelo	Unds.	Código	EAN	P.V.P. (€)
5 Pre-filtros + filtro	EK7301WS EK8100WS DPC7331 DPC8132	1	957173190	-	21,15
5 Pre-filtros, filtro y cajetín de polvo	EK7651H	1	195599-9	0088381376884	70,00



Aceites



Descripción	Unds.	Código	EAN	P.V.P. (€)
Aceite de motor 4T (220ml) EK7651H	1	195532-1	0088381401937	8,00

Bomba de presión



Modelos	Unds.	Código	EAN	P.V.P. (€)
DPC7331 DPC8132 EK6100 EK7651H 4101RH	1	957802600	4002829128633	434,00

Kit de agua para EK7651

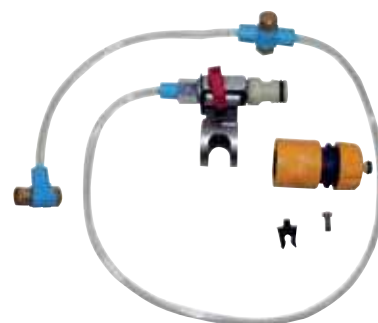

Modelo	Unds.	Código	EAN	P.V.P. (€)
EK7651	1	195534-7	3240890392091	28,00



Pie con ruedas



Modelos	Unds.	Código	EAN	P.V.P. (€)
EK8100WS EK7301WS	1	394114272	-	64,00

Carros de transporte



Tipo	Modelo	Unds.	Código	EAN	P.V.P. (€)
DT4000	EK7651H	1	196354-2	0088381430517	987,00
DT2010	DPC6430 DPC7331 DPC8132 EK7301WS EK8100WS	1	197980-0	-	987,00



Makita

Accesorios para DCC501



191X01-4

140Y22-9

140Y23-7

127750-3

126738-0



Capaz de cortar tanto en húmedo como en seco cambiando el protector. Cortes en piedra, mampostería, baldosas, hormigón y más.



Descripción	Unds.	Código	EAN	P.V.P. (€)
Kit de agua completo	1	191X01-4	-	58,00
Tubo de agua completo	1	140Y23-7	-	7,40
Adaptador tanque de agua	1	140Y22-9	-	8,50
Depósito de agua	1	140Y25-3	-	3,90
Cajetín de polvo	1	127750-3	-	14,10
Bolsa de polvo	1	126738-0	0088381589802	6,40



Cortador

CE001G XGT

XGT X2
80V max



Botón on/off de la luz LED y botón de bloqueo

Luz indicadora de sobrecarga



Luz LED de trabajo



Se puede conectar un accesorio de suministro de agua.



Máx. capacidad de corte
127mm

Equipada con:

BL MOTOR **AFT** **WG WET GUARD** **XPT EXTREME PROTECTION TECHNOLOGY**

Velocidad de corte de hormigón

CE001G

Modelo anterior de gasolina

Batería: BL4050F x 2 (una sola carga)

Corte de hormigón de forma continua: 50x300mm
Disco de diamante: 355mm

Equipado con carcasa antivibración

Con resorte incorporado para absorber la vibración del corte en la empuñadura delantera y trasera.

Mango delantero / Mango trasero

2,0/1,2 m/s

Muelle antivibración



Carcasa antivibración

Área de movimiento

Abrasivo lijas



Lijadoras orbitales

Lijas para BO4556



- Excelente rendimiento de lijado en aplicaciones profesionales.
- Aplicaciones: lijado de madera, hierro y madera pintada. Óxido de aluminio.
- Con grano semi abierto y recubrimiento de resina sobre cola.

Medida (mm)	Grano	Unds.	Código	EAN	P.V.P. (€)
114 x 140	40	10	P-36398	0088381972109	4,10
	60		P-32904	0088381961066	3,60
	80		P-36407	0088381972116	3,60
	100		P-32910	0088381961073	3,30
	120		P-32926	0088381961080	3,30
	150		P-32932	0088381961097	3,05
	180		P-36413	0088381972123	3,30
	240		P-36429	0088381972130	3,30

Lijas para BO4566

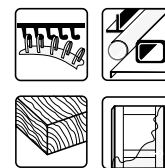
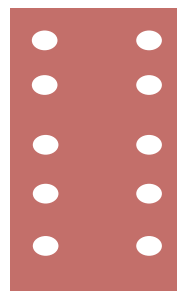

- Lija de grano abierto de corindón con doble recubrimiento de resina.
- Aplicaciones: lijado de maderas secas, pintadas o barnizadas.
- También para metal. Perfecta para ebanistería y carrocería. Orificios de aspiración 5+5.

Medida (mm)	Grano	Unds.	Código	EAN	P.V.P. (€)
100 x 240	40	10	P-42868	0088381970730	6,60
	60		P-42874	0088381970747	6,60
	80		P-42880	0088381970754	6,30
	100		P-42896	0088381970761	6,30
	120		P-42905	0088381970778	6,30
	150		P-42911	0088381970785	6,00
	180		P-42927	0088381970792	6,00
	240		P-42933	0088381970808	6,00

- Especial pintura.
- Excelente rendimiento en aplicaciones profesionales.
- Aplicaciones: lijado de pintura, barniz, madera pintada...

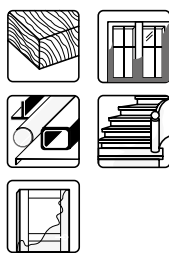

Medida (mm)	Grano	Unds.	Código	EAN	P.V.P. (€)
114 x 140	40	10	P-36516	0088381972222	5,00
	60		P-36522	0088381972239	4,40
	80		P-36538	0088381972246	4,40
	100		P-36544	0088381972253	4,40
	120		P-36550	0088381972260	4,40
	150		P-36566	0088381972277	4,40
	180		P-36572	0088381972284	4,40
	240		P-36588	0088381972291	4,40



Makita

Lijadoras orbitales

Lijas para BO4565

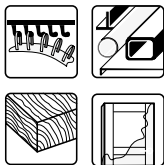

- Excelente rendimiento de lijado en aplicaciones profesionales.
- Aplicaciones: lijado de madera, hierro y madera pintada.
- Óxido de aluminio extra resistente y agarre por velcro. Orificios de aspiración 3+3.

Medida (mm)	Grano	Unds.	Código	EAN	P.V.P. (€)
114 x 102	40	10	P-33087	0088381961240	5,00
	60		P-33093	0088381961257	5,00
	80		P-33102	0088381961264	5,00
	100		P-33118	0088381961271	5,00
	120		P-33124	0088381961288	4,40
	150		P-33130	0088381961295	4,40
	180		P-33146	0088381961301	4,40
	240		P-33152	0088381961318	4,40
	320		P-33168	0088381961325	4,40

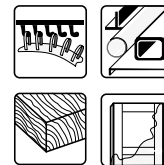

- Para el uso con la mayoría de lijadoras tipo delta con base triangular.
- Aplicaciones: lijado de madera, metal. Ideal para esquinas y lijado de acabado.
- Lija triangular con agarre por velcro y 6 orificios para aspiración.

Medida (mm)	Grano	Unds.	Código	EAN	P.V.P. (€)
93 x 93 x 93	40	10	P-33255	0088381961417	4,10
	60		P-33261	0088381961424	4,10
	80		P-33277	0088381961431	4,10
	100		P-33283	0088381961448	3,90
	120		P-33299	0088381961455	3,90
	150		P-33308	0088381961462	3,90
	180		P-33314	0088381961479	3,90
	240		P-33320	0088381961486	3,90
	320		P-33336	0088381961493	3,90

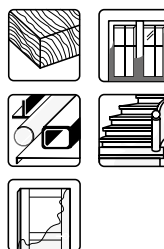

- Especial pintura. Excelente rendimiento en aplicaciones profesionales. 6 orificios de aspiración.
- Aplicaciones: lijado de pintura, barniz, madera pintada.

Medida (mm)	Grano	Unds.	Código	EAN	P.V.P. (€)
114 x 102	40	10	P-35807	0088381964968	5,80
	60		P-35813	0088381964975	5,50
	80		P-35829	0088381964982	5,20
	100		P-35835	0088381964999	5,20
	120		P-35841	0088381965002	5,20
	150		P-35857	0088381966016	5,20
	180		P-35863	0088381966023	5,20
	240		P-35879	0088381966030	5,20
	320		P-35885	0088381966047	5,20



- Especial pintura. Para el uso con la mayoría de lijadoras tipo delta con base triangular. 6 orificios de aspiración.
- Excelente rendimiento en aplicaciones profesionales.
- Aplicaciones: lijado de pintura, barniz, madera pintada.

Medida (mm)	Grano	Unds.	Código	EAN	P.V.P. (€)
93 x 93 x 93	40	10	P-42684	0088381970556	4,40
	60		P-42690	0088381970563	4,10
	80		P-42709	0088381970570	4,10
	100		P-42715	0088381970587	4,10
	120		P-42721	0088381970594	4,10
	150		P-42737	0088381970600	4,10
	180		P-42743	0088381970617	4,10
	240		P-42759	0088381970624	4,10
	320		P-42765	0088381970631	4,10

Lijadoras orbitales

Lijas para BO3700 / 9036 / BO3711 / DBO380 / DBO381

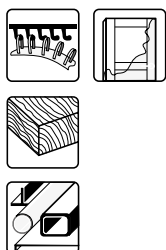

- Excelente rendimiento de lijado en aplicaciones profesionales.
- Aplicaciones: Lijado de madera, hierro y madera pintada. Perforaciones 4+4.

Medida (mm)	Grano	Unds.	Código	EAN	P.V.P. (€)
93 x 185	40	10	P-31871	0088381960038	5,50
	60		P-31887	0088381960045	5,00
	80		P-31893	0088381960052	5,00
	100		P-31902	0088381960069	5,00
	120		P-35891	0088381966054	5,00
	150		P-35900	0088381966061	5,00
	180		P-35916	0088381966078	5,00
	240		P-35922	0088381966085	5,00



- Excelente rendimiento de lijado en aplicaciones profesionales.
- Lija de grano abierto de corindón con doble recubrimiento de resina.
- Ideal para el lijado de maderas secas, pintadas o barnizadas.
- También válida para metal. Perfecta para ebanistería y carrocería.

Medida (mm)	Grano	Unds.	Código	EAN	P.V.P. (€)
93 x 228	40	10	P-36136	0088381966290	3,30
	60		P-32948	0088381961103	3,05
	80		P-36142	0088381966306	3,05
	100		P-32954	0088381961110	3,05
	120		P-36158	0088381966313	3,05
	150		P-32960	0088381961127	2,45



- Excelente rendimiento de lijado en aplicaciones profesionales.
- Lija de grano abierto de corindón con doble recubrimiento de resina.
- Ideal para el lijado de maderas secas, pintadas o barnizadas. También válida para metal.
- Perfecta para ebanistería y carrocería.
- Perforaciones 4+4.

Medida (mm)	Grano	Unds.	Código	EAN	P.V.P. (€)
93 x 228	40	10	P-31837	0088381959995	3,90
	60		P-31843	0088381960007	3,60
	80		P-31859	0088381960014	3,60
	100		P-31865	0088381960021	3,60
	120		P-36011	0088381966177	3,60
	150		P-36027	0088381966184	3,60
	180		P-36033	0088381966191	3,60
	240		P-36049	0088381966207	3,60



Makita

Lijadoras orbitales

Lijas para BO4900V / 9046 / BO4901

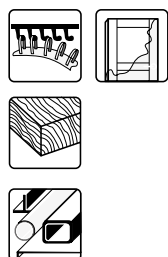

- Excelente rendimiento de lijado en aplicaciones profesionales.
- Lija de grano abierto de corindón con doble recubrimiento de resina.
- Ideal para el lijado de maderas secas, pintadas o barnizadas.
- También válida para metal.
- Perfecta para ebanistería y carrocería.
- Perforaciones 5+5.

Medida (mm)	Grano	Unds.	Código	EAN	P.V.P. (€)
115 x 229	40	10	P-33174	0088381961332	6,90
	60		P-33180	0088381961349	6,60
	80		P-33196	0088381961356	6,60
	100		P-33205	0088381961363	6,60
	120		P-33211	0088381961370	6,60
	180		P-33233	0088381961394	6,30
	240		P-33249	0088381961400	6,30

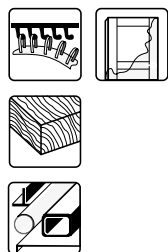

- Lija de alta resistencia. Excelente rendimiento de lijado en aplicaciones profesionales.
- Lija de grano abierto de corindón con doble recubrimiento de resina.
- Ideal para el lijado de maderas secas, pintadas o barnizadas. También válida para metal.
- Perfecta para ebanistería y carrocería.
- Perforaciones 5+5+2+2.

Medida (mm)	Grano	Unds.	Código	EAN	P.V.P. (€)
115 x 229	40	10	P-43022	0088381970891	7,70
	60		P-43038	0088381970907	7,20
	80		P-43044	0088381970914	6,90
	100		P-43050	0088381970921	6,60
	120		P-43066	0088381970938	6,60
	150		P-43072	0088381970945	6,00
	180		P-43088	0088381970952	6,60
	240		P-43094	0088381970969	6,60



- Excelente rendimiento de lijado en aplicaciones profesionales.
- Lija de grano abierto de corindón con doble recubrimiento de resina.
- Ideal para el lijado de maderas secas, pintadas o barnizadas.
- También válida para metal.
- Perfecta para ebanistería y carrocería.
- Perforaciones 5+5+2+2.

Medida (mm)	Grano	Unds.	Código	EAN	P.V.P. (€)
115 x 280	40	10	P-33009	0088381961165	4,70
	60		P-33015	0088381961172	4,40
	80		P-33021	0088381961189	4,40
	100		P-33037	0088381961196	4,40
	120		P-33043	0088381961202	4,40
	150		P-33059	0088381961219	4,40
	180		P-33065	0088381961226	4,40
	240		P-33071	0088381961233	4,10



- Excelente rendimiento de lijado en aplicaciones profesionales.
- Lija de grano abierto de corindón con doble recubrimiento de resina.
- Ideal para el lijado de maderas secas, pintadas o barnizadas.
- También válida para metal.
- Perfecta para ebanistería y carrocería.

Medida (mm)	Grano	Unds.	Código	EAN	P.V.P. (€)
115 x 280	40	10	P-36267	0088381966429	4,40
	60		P-32976	0088381961134	4,10
	80		P-36273	0088381966436	4,10
	100		P-32982	0088381961141	4,10
	120		P-36289	0088381966443	4,10
	150		P-32998	0088381961158	3,30



Lijadoras orbitales

Rollos de lija



- Para uso general. Válido para madera, metal, pintura y barniz.
- Rollo de 5 m.
- Ideal para lijadoras orbitales.
- Válido como lija de mano.

Ancho (mm)	Grano	Longitud (m)	Unds.	Código	EAN	P.V.P. (€)
120	40	5	1	P-38102	0088381973816	8,60
	60			P-38118	0088381973823	6,60
	80			P-38124	0088381973830	5,80
	100			P-38130	0088381973847	5,50
	120			P-38146	0088381973854	5,50
	180			P-38152	0088381973861	5,50
	240			P-38168	0088381973878	5,50
	320			P-38174	0088381973885	5,50
	400			P-38180	0088381973892	4,40



- Para uso general. Válido para madera, metal, pintura y barniz.
- Rollo de 50 m.
- Ideal para lijadoras orbitales.
- Válido como lija de mano.

Ancho (mm)	Grano	Longitud (m)	Unds.	Código	EAN	P.V.P. (€)
120	40	50	1	P-38196	0088381973908	59,00
	60			P-38205	0088381973915	48,00
	80			P-38211	0088381973922	42,00
	100			P-38227	0088381973939	39,00
	120			P-38233	0088381973946	39,00
	180			P-38249	0088381973953	39,00
	240			P-38255	0088381973960	39,00
	320			P-38261	0088381973977	39,00
	400			P-38277	0088381973984	39,00

Bases para lijadoras orbitales



158324-9



158326-5



158325-7



140441-9

Modelo	Tipo	Medida	Unds.	Código	EAN	P.V.P. (€)
BO4556 BO4565 BO4566	Cuadrada Goma *	112 x 102	1	158324-9	0088381413596	3,40
	Triangular Velcro	112 x 190	1	158325-7	3240890999597	8,95
	Rectangular Velcro	100 x 164	1	158326-5	3240890999580	7,80
BO3700 BO3711	Goma	93 x 185	1	140441-9	-	4,75
	Velcro	93 x 185	1	194930-6	0088381355759	15,40
BO4900V BO4901	Goma	115 x 229	1	193523-6	0088381164719	16,70
	Velcro	115 x 229	1	193521-0	0088381164702	31,20
9046	Velcro	115 x 229	1	162172-0	3240890063304	40,95

* Para cambiar la base de goma de BO4556 a base de velcro triangular o rectangular es necesario utilizar base 450068-0.
** Esta base se considera accesorios.



Lijadoras rotorbitales

Lijas para BO5040 / BO5041 / DBO180

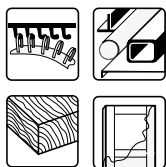

- Lija de grano semiabierto de óxido de aluminio, con recubrimiento de resinas fenólicas.
- Ideal para trabajos en madera, plástico, metal en planchas, maderas barnizadas y metales pintados.
- Perforaciones 8.

Ø (mm)	Grano	Unds.	Código	EAN	P.V.P. (€)
125	40	10	P-43533	0088381971409	5,50
	60		P-43549	0088381971416	5,20
	80		P-43555	0088381971423	5,00
	100		P-43561	0088381971430	5,00
	120		P-43577	0088381971447	5,00
	180		P-43583	0088381971454	5,00
	240		P-43599	0088381971461	5,00
	320		P-43608	0088381971478	4,70
	400		P-43614	0088381971485	4,70

Lijas para BO6030 / BO6050

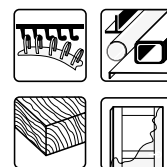

- Lija de grano semiabierto de óxido de aluminio, con recubrimiento de resinas fenólicas.
- Ideal para trabajos en madera, plástico, metal en planchas, maderas barnizadas y metales pintados.
- Perforaciones 8.

Ø (mm)	Grano	Unds.	Código	EAN	P.V.P. (€)
150	40	10	P-31918	0088381960076	7,70
	60		P-31924	0088381960083	7,40
	80		P-31930	0088381960090	7,20
	100		P-31946	0088381960106	6,90
	120		P-31952	0088381960113	6,90
	150		P-31968	0088381960120	6,90
	180		P-31974	0088381960137	6,90
	220		P-31980	0088381960144	6,90
	240		P-31996	0088381960151	6,90
	320		P-32007	0088381960168	6,90
	400		P-32013	0088381960175	6,90

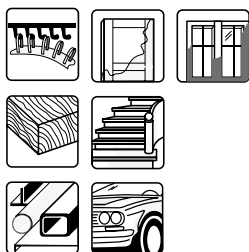

- Especial pintura.
- Excelente rendimiento en trabajos de automoción.
- Recubrimiento antiestático que previene atascos en la lija para un acabado más fino.
- Perforaciones 8.

Ø (mm)	Grano	Unds.	Código	EAN	P.V.P. (€)
125	40	10	P-33342	0088381961509	5,00
	60		P-33358	0088381961516	4,70
	80		P-33364	0088381961523	4,40
	100		P-33370	0088381961530	4,40
	120		P-33386	0088381961547	4,40
	180		P-33392	0088381961554	4,40
	240		P-33401	0088381961561	4,40
	320		P-33417	0088381961578	4,40
	400		P-33423	0088381961585	4,40

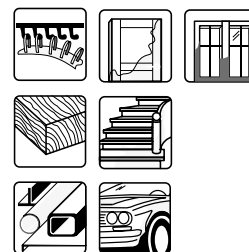
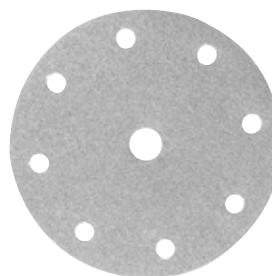

- Especial pintura.
- Excelente rendimiento en trabajos de automoción.
- Recubrimiento antiestático que previene atascos en la lija para un acabado más fino.
- Perforaciones 8.

Ø (mm)	Grano	Unds.	Código	EAN	P.V.P. (€)
150	40	10	P-37839	0088381973540	7,40
	60		P-37845	0088381973557	6,90
	80		P-37851	0088381973564	6,60
	100		P-37867	0088381973571	6,30
	120		P-37873	0088381973588	6,30
	150		P-37889	0088381973595	6,30
	180		P-37895	0088381973601	6,30
	220		P-37904	0088381973618	6,30
	240		P-37910	0088381973625	6,30
	320		P-37926	0088381973632	6,30
	400		P-37932	0088381973649	6,30

Lijadoras roborbitales y de disco

Cajas de discos de velcro perforados de 150mm

- Gama de lijas de óxido de aluminio para lijadoras roborbitales de 150mm.
- Paquetes de 50 y 100 unidades.
- Ideales para usuarios con gran consumo de lijas.
- Perfectas para el acabado en fibra de vidrio, madera, metal y chapa de automóvil.
- Perforaciones 8+6.

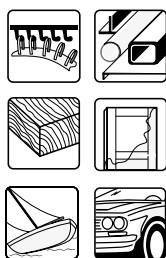

Ø (mm)	Grano	Unds.	Código	EAN	P.V.P. (€)
150	40	50	B-39300	0088381434041	31,00
	60		B-39316	0088381434058	29,00
	80		B-39322	0088381434065	51,00
	100	100	B-39338	0088381434072	48,00
	120		B-39344	0088381434089	46,00
	240		B-39350	0088381434096	45,00
	320		B-39366	0088381434102	45,00
	360		B-39372	0088381434119	45,00
	400		B-39388	0088381434126	45,00
	500		B-39394	0088381434133	45,00
	600	100	B-39403	0088381434140	45,00
	800		B-39419	0088381434157	45,00
	1.000		B-39425	0088381434164	45,00

Lijas para jirafa de 225mm

- Discos especiales para trabajos en tabiquería seca.
- Grano cerámico con resina.
- Recubrimiento especial, previene que se emboce y evita el desgaste.
- Más durabilidad que un disco abrasivo.

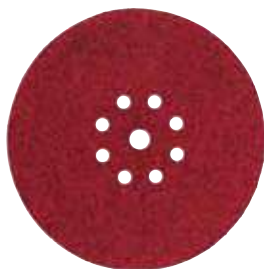

Ø (mm)	Grano	Unds.	Código	EAN	P.V.P. (€)
225	40	25	B-68389	0088381545891	34,00
	80		B-68395	0088381545907	33,00
	120		B-68404	0088381545914	29,00
	180		B-68410	0088381545921	29,00
	320		B-68426	0088381545938	29,00

Lijas de discos 115mm / 125mm / 180mm

- Discos de fibra excelentes para quitar barnices y pinturas en madera y metal, así como repasos en soldaduras.



Ø (mm)	Grano	Unds.	Código	EAN	P.V.P. (€)
115	24	5	P-00860	0088381918787	4,50
	40		P-00882	0088381918800	5,90
	60		P-00907	0088381918824	5,90
	80		P-00913	0088381918831	5,90
	120		P-00935	0088381918848	6,20
125	24		P-00957	0088381922203	5,40
	40		P-00979	0088381922227	6,70
	60		P-00985	0088381922234	6,70
	80		P-00991	0088381922241	7,00
	100		P-01002	0088381922258	7,30
	120		P-01018	0088381922265	7,30
180	24		P-01030	0088381918879	8,50
	40		P-01052	0088381918893	8,70
	60		P-01074	0088381918916	8,70
	80		P-01080	0088381918923	8,70
	100	P-01096	0088381918930	8,10	
	120	P-01105	0088381918947	8,10	

Lijas para lijadoras de disco 180mm

- Lija de óxido de aluminio de grano abierto con recubrimiento de resina y pegamento con base de látex.
- Excelente rendimiento en trabajos de automoción.
- Perfecta para los trabajos en maderas sin tratar, maderas barnizadas, carrocería.
- Especial para el lijado de pintura.

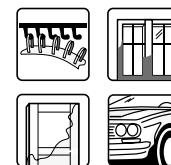

Ø (mm)	Grano	Unds.	Código	EAN	P.V.P. (€)
180	40	10	P-33439	0088381961592	11,00
	60		P-38037	0088381973748	9,10
	80		P-33445	0088381961608	8,60
	100		P-38043	0088381973755	8,20
	120		P-33451	0088381961615	8,20
	240		P-38059	0088381973762	8,20
	320		P-38065	0088381973779	8,20

Platos de velcro para lijadoras / pulidoras de disco



197925-8

PO6000C



743060-6

M14



199939-3

DSL801

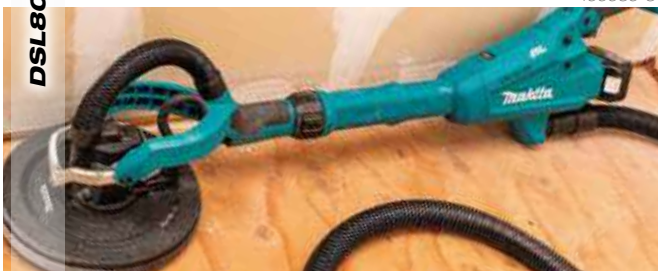

Descripción	Ø (mm)	Unds.	Código	EAN	P.V.P. (€)
PO6000C	100	1	197925-8	00883811468367	62,00
	125		197922-4	00883811468343	61,00
	150		197928-2	00883811468381	61,00
M14	115		743060-6	0088381156967	16,50
	117		P-21777	0088381948876	13,20
	165	743053-3	0088381146104	21,00	
DSL800 DSL801	Blando	210	199939-3	0088381546157	58,00
	Medio		199940-8	0088381546164	65,00
	Duro		199938-5	0088381546140	63,00

Platos de caucho para lijadoras / pulidoras de disco



Descripción	Ø (mm)	Unds.	Código	EAN	P.V.P. (€)
Necesita tuerca	115	1	743015-1	0088381102094	9,50
	120		743025-8	0088381101295	5,00
	125		743016-9	0088381109017	10,20
	170		743008-8	0088381109055	25,00
5/8"	170		743012-7	0088381101233	16,50

Tuerca para platos de caucho



Descripción	Unds.	Código	EAN	P.V.P. (€)
M14	1	224515-5	008838116190	5,50

Bases para DBO480/81/82



191Y22-2



191Y23-0



191Y24-8



191Y25-6



Descripción	Unds.	Código	EAN	P.V.P. (€)
Triangular velcro	1	191Y22-2	0088381590976	10,20
Rectangular velcro	1	191Y23-0	0088381590983	8,00
Cuadrada velcro y pinzas	1	191Y24-8	0088381590990	6,70
Cuadrada velcro	1	191Y25-6	0088381591003	6,00



Lijas para lijadoras de banda

- Lija de óxido de aluminio con grano cerrado y doble recubrimiento de resina sobre base de tela.
- Producto de gran resistencia diseñado especialmente para lijadoras de banda.
- Válidas para todo tipo de maderas y metales.



Modelos	Medida (mm)	Grano	Unds.	Código	EAN	P.V.P. (€)
9910 9911	76 x 457	40	5	P-37091	0088381972802	9,90
		60		P-37100	0088381972819	9,60
		80		P-37116	0088381972826	9,60
		100		P-37122	0088381972833	9,60
		120		P-37138	0088381972840	9,60
		150		P-37144	0088381972857	9,60
		240		P-37150	0088381972864	9,60



Modelo	Medida (mm)	Grano	Unds.	Código	EAN	P.V.P. (€)
9903	76 x 533	40	5	P-37172	0088381972888	10,50
		60		P-37188	0088381972895	9,90
		80		P-37194	0088381972901	9,40
		100		P-37203	0088381972918	9,10
		120		P-37219	0088381972925	9,10
		150		P-37225	0088381972932	9,10
		240		P-37231	0088381972949	9,10



Modelos	Medida (mm)	Grano	Unds.	Código	EAN	P.V.P. (€)
9920 9924DB	76 x 610	40	5	P-37312	0088381973021	11,60
		60		P-37328	0088381973038	11,00
		80		P-37334	0088381973045	10,50
		100		P-37340	0088381973052	9,60
		120		P-37356	0088381973069	9,60
		150		P-37362	0088381973076	9,60
		240		P-37378	0088381973083	9,60

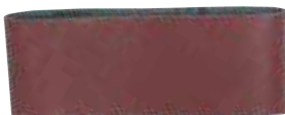

Modelos	Medida (mm)	Grano	Unds.	Código	EAN	P.V.P. (€)
9402 9403 9404	100 x 610	40	5	P-36887	0088381972598	13,80
		60		P-36893	0088381972604	12,70
		80		P-36902	0088381972611	12,70
		100		P-36918	0088381972628	12,70
		120		P-36924	0088381972635	12,70
		150		P-36930	0088381972642	12,70
		240		P-36946	0088381972659	12,70

Placas grafitadas



Modelo	Unds.	Código	EAN	P.V.P. (€)
9924DB	1	423036-6	008838116398	2,35
9402		423029-3	008838116367	3,00
9403		421648-9	0088381148191	3,70
9404		193201-8	0088381157056	7,80
9903		423315-2	0088381154291	2,50
9920		423316-0	0088381154307	3,05

Placas de corcho



Modelo	Unds.	Código	EAN	P.V.P. (€)
9404	1	193202-6	0088381157063	5,20
9903		423312-8	0088381154321	2,20
9402		421093-8	0088381123839	4,40
9924DB		423035-8	0088381152532	4,10
9403		421646-3	0088381148177	2,80
9901		423149-3	0088381126397	2,80
9920		423313-6	0088381154338	2,80

Placas metal



Modelo	Unds.	Código	EAN	P.V.P. (€)
9402	1	342328-3	008838116244	3,05
9924DB		341705-6	008838116268	3,60
9404		151751-9	0088381154284	8,60
9902 9903		151749-6	0088381154246	5,50
9920		151750-1	0088381154277	5,50
9403 (metal + corcho)		150980-1	0088381148153	5,50
9903		344620-3	0088381148160	2,30
9910 9911		344586-7	0088381146791	2,80

Lijas de banda de alta calidad para 9032

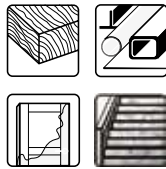
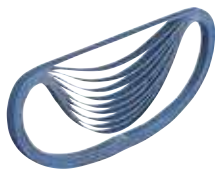

10uds

Modelo	Medida (mm)	Grano	Unds.	Código	EAN	P.V.P. (€)
9032	6x533	80	10	A-34534	0088381164450	22,00
		100		A-34540	0088381164467	20,00
		120		A-34556	0088381164474	19,30
	9x533	40		A-34447	0088381164382	22,00
		60		A-34453	0088381164399	22,00
		80		A-34469	0088381164405	20,00
		100		A-34475	0088381164412	17,70
		120		A-34481	0088381164429	17,70
		13x533		40	A-34562	0088381164481
	60			A-34578	0088381164498	25,00
	80			A-34584	0088381164504	24,00
	100			A-34590	0088381164511	24,00
	120	A-34609	0088381164528	20,00		

25uds

Modelo	Medida (mm)	Grano	Unds.	Código	EAN	P.V.P. (€)
9032	6x533	60	25	P-39394	0088381967266	32,00
	6x533	100		P-39419	0088381967280	32,00
	6x533	120		P-39425	0088381967297	32,00

Lijas de banda de alta calidad para 9031



Modelo	Medida (mm)	Grano	Unds.	Código	EAN	P.V.P. (€)
9031	30 x 533	40	5	P-36675	0088381972383	5,20
	30 x 533	60		P-36681	0088381972390	4,70
	30 x 533	80		P-36697	0088381972406	4,70
	30 x 533	100		P-36706	0088381972413	4,70
	30 x 533	120		P-36712	0088381972420	4,70
	30 x 533	150		P-36728	0088381972437	4,70
	30 x 533	240		P-36734	0088381972444	4,70

Lijas de banda para LB1200F



Grano	Dimensiones (mm)	Unds.	Código	EAN	P.V.P. (€)
80	20 x 2240	1	B-42581	0088381440738	14,30
120	20 x 2240		B-42597	0088381440745	14,30

Lijas de banda estándar para 9032

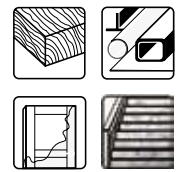

5uds

Modelo	Medida (mm)	Grano	Unds.	Código	EAN	P.V.P. (€)	
9032	6x533	40	5	P-43181	0088381971058	5,80	
		60		P-43197	0088381971065	5,80	
		80		P-43206	0088381971072	5,50	
		100		P-43212	0088381971089	5,50	
		120		P-43228	0088381971096	5,50	
		150		P-43234	0088381971102	5,50	
		240		P-43240	0088381971119	5,50	
		9x533		40	P-43256	0088381971126	6,60
				60	P-43262	0088381971133	6,60
				80	P-43278	0088381971140	6,30
				100	P-43284	0088381971157	6,30
				120	P-43290	0088381971164	6,30
	150		P-43309	0088381971171	6,30		
	240		P-43315	0088381971188	6,30		
	13x533		40	P-43321	0088381971195	8,60	
			60	P-43337	0088381971201	8,20	
			80	P-43343	0088381971218	8,00	
			100	P-43359	0088381971225	7,70	
			120	P-43365	0088381971232	7,70	
		150	P-43371	0088381971249	8,00		
		240	P-43387	0088381971256	8,00		

Lija de banda especial cristal para 9031



Modelo	Medida (mm)	Grano	Unds.	Código	EAN	P.V.P. (€)
9031	30 x 533	40	5	P-01395	0088381922302	12,10
	30 x 533	60		P-01404	0088381922319	12,10
	30 x 533	80		P-01199	0088381913928	11,00
	30 x 533	100		P-01208	0088381913935	11,00
	30 x 533	120		P-01214	0088381913942	11,00
	30 x 533	150		P-01220	0088381913959	11,00
	30 x 533	180		P-01236	0088381913966	11,00



Accesorios de pulido para PV301 y DPV300



743126-2



743124-6



Descripción	Grano	Unds.	Código	EAN	P.V.P. (€)
Discos de lija	A60	25	E-07412	0088381574044	47,00
	A80		E-07428	0088381574051	47,00
	A120		E-07434	0088381574068	47,00
	Z60		E-07440	0088381574075	47,00
	Z80		E-07456	0088381574082	47,00
Discos abrasivos para superficie	Grueso	25	E-07462	0088381574099	87,00
	Medio		E-07478	0088381574105	87,00
	Fino		E-07484	0088381574112	87,00
	Medio		E-07490	0088381574129	76,00
	Fino		E-07509	0088381574136	76,00
	Muy fino		E-07515	0088381574143	76,00
Adaptador	-	1	743126-2		5,60
Plato	-	1	743124-6	0088381587853	14,30



191N90-9



191N91-7



191N92-5



743125-4



Descripción	Grano	Unds.	Código	EAN	P.V.P. (€)
Esponja de velcro (basto)	80	1	191N90-9	0088381577045	10,20
Esponja de velcro (medio)	80	1	191N91-7	0088381577052	12,70
Boina de lana con velcro	80	1	191N92-5	0088381577069	12,70
Plato de velcro	80	1	743125-4	0088381587860	37,00





PV001GZ



XGT
40V Li-ion
max





Adaptador de boina doble



Descripción	Unds.	Código	EAN	P.V.P. (€)
Adaptador boina doble	1	D-56960	0088381457620	2,30

Plato velcro



Modelo	Descripción	Ø (mm)	Unds.	Código	EAN	P.V.P. (€)
BO5030 BO5031 BO5040 BO5041	Blando (lijado general)	123	1	743081-8	0088381350044	32,00
BO6040 BO6030	Duro (lijado grueso)	150		196685-9	0088381438957	26,00
	Blando (lijado general)	150		196684-1	0088381438940	30,00
	Súper blando (lijado fino)	150		196686-7	0088381438964	29,00
BO6050J	Duro (lijado grueso)	150		197315-5	0088381461955	52,00
	Blando (lijado general)	150		197314-7	0088381461948	48,00
	Súper blando (lijado fino)	150		197316-3	0088381461962	52,00
	Pulido	130		197317-1	0088381461979	48,00

Boina de lana doble ★★



Ø (mm)	Modelos	Unds.	Código	EAN	P.V.P. (€)
230	9237CB	1	D-70873	0088381557771	18,70

Boinas de lana con velcro. Pulidos alto brillo ★★★



Ø (mm)	Unds.	Código	EAN	P.V.P. (€)
100	1	197896-9	0088381468305	18,20
125		197897-7	0088381468329	16,00
150		199424-6	0088381534567	28,00
150		794560-9	0088381149365	24,00
180		192629-7	0088381140690	21,00
180		D-74594	-	13,90

Boinas de lana ★★★



794176-0

Ø (mm)	Tipo	Unds.	Código	EAN	P.V.P. (€)
100	Lana	1	794173-6	0088381103848	13,20
180	Cordero		794176-0	0088381117159	24,00

Filtro (con velcro)



Ø (mm)	Tipo	Unds.	Código	EAN	P.V.P. (€)	
100	Velcro	1	197895-1	0088381468282	29,00	★★★★★
125			196152-4	0088381413572	26,00	★★★★★
125			D-74631	0088381588218	7,20	★★
150			794618-4	0088381157841	20,00	★★★★★
150			193288-0	-	24,50	★★★★★
150			D-74619	0088381588195	9,90	★★
180			D-74625	0088381588201	11,50	★★



Esponjas de velcro



D-70786



D-70792



P-21733

Ø (mm)	Tipo	Unds.	Código	EAN	P.V.P. (€)	
100	-	Lisa	197893-5	0088381468244	18,70	★★★
125	-	Lisa	794558-6	0088381149358	26,00	★★★
125	-	Lisa	D-74653	0088381588300	10,20	★★
150	-	Lisa	D-74669	0088381588317	13,10	★★
150	-	Lisa	197894-3	0088381468268	22,00	★★★
190	Basto	Lisa	D-70786	0088381556071	18,70	★★
190	Medio	Lisa	D-70792	0088381556088	18,70	★★
150	Basto	Lisa	P-21727	0088381948821	15,40	★★★
150	Fino	Lisa	P-21733	0088381948838	10,80	★★★



Esponjas de velcro

★★



Ø (mm)	Tipo	Unds.	Código	EAN	P.V.P. (€)
100	Basto	Lisa	D-62505	0088381498142	4,90
125	Basto	Lisa	D-62511	0088381498159	7,00
150	Basto	Lisa	D-62527	0088381498166	8,20
180	Basto	Lisa	D-74572	0088381588157	13,10



Ø (mm)	Tipo	Unds.	Código	EAN	P.V.P. (€)
100	Medio	Lisa	D-62533	0088381498173	4,90
125	Medio	Lisa	D-62549	0088381498180	7,00
150	Medio	Lisa	D-62555	0088381498197	8,20
180	Medio	Lisa	D-74588	0088381588164	13,10



Ø (mm)	Tipo	Unds.	Código	EAN	P.V.P. (€)
100	Fino	Lisa	D-62561	0088381498203	4,90
125	Fino	Lisa	D-62577	0088381498210	7,00
150	Fino	Lisa	D-62583	0088381498227	8,20
180	Fino	Lisa	D-70801	0088381556095	13,10



Ø (mm)	Tipo	Unds.	Código	EAN	P.V.P. (€)
100	Basto	Ondulada	D-62599	0088381498234	4,90
125	Basto	Ondulada	D-62608	0088381498241	7,00
150	Basto	Ondulada	D-62614	0088381498258	8,20



Ø (mm)	Tipo	Unds.	Código	EAN	P.V.P. (€)
100	Medio	Ondulada	D-62620	0088381498265	4,90
125	Medio	Ondulada	D-62636	0088381498272	7,00
150	Medio	Ondulada	D-62642	0088381498289	8,20



Ø (mm)	Tipo	Unds.	Código	EAN	P.V.P. (€)
100	Fino	Ondulada	D-62658	0088381498296	4,90
125	Fino	Ondulada	D-62664	0088381498302	7,00
150	Fino	Ondulada	D-62670	0088381498319	8,20



Placas perforadoras



Modelo	Tipo	Unds.	Código	EAN	P.V.P. (€)
BO4553	Metálica	1	413094-0	0088381201025	1,40
BO4556	Plástico	1	450066-4	0088381346085	0,95
BO3711	Metálica	1	192989-7	0088381151160	7,70
9046 BO4900V BO4901	Metálica	1	192523-3	0088381132282	22,00



Soporte + Bolsa de papel



Descripción	Modelo	Unds.	Código	EAN	P.V.P. (€)
Soporte + Bolsa	BO4900V BO5020 BO5021 BO6030 BO9046	1	193294-5	0088381160247	13,20

Bolsas de tela



Descripción	Modelo	Unds.	Código	EAN	P.V.P. (€)
Tela roja (con adaptador)	9046	1	152456-4	0088381133548	22,00
Tela roja (con adaptador)	BO3700	1	151780-2	0088381156929	2,60
Tela roja (sin adaptador) para 151518-5	BO4901 BO4900V BO6030	1	151517-7*	0088381150859	8,80
Tela (con adaptador)	BO4556 BO4565 BO4566	1	135222-4	0088381435918	4,90

* Válidas para cajón recoge polvo.

Bolsas de papel y nylon



Descripción	Modelo	Unds.	Código	EAN	P.V.P. (€)
Papel (11cm)	BO3711 BO4556 BO4565 BO4566 BO5030 BO5031 BO5040 BO5041	5	194746-9*	0088381352017	5,50
Papel (15cm)	BO4553	5	193712-3	0088381181730	6,70
Papel (larga)	BO4900V BO6030 9046	5	193293-7	0088381160254	8,10
Nylon (11cm)	BO4556 BO4565 BO4566	1	168557-8*	3240890313324	2,65

Cajon recoge polvo



Descripción	Modelo	Unds.	Código	EAN	P.V.P. (€)
Con adaptador y bolsa de papel pequeña	BO5030 BO5031 BO5040 BO5041	1	135246-0	0088381403528	5,00
Con adaptador y bolsa de nylon	BO3711 DB0180 DB0380 DB0381	1	135327-0	0088381365611	6,60
Sin adaptador y sin bolsa		1	450770-5	-	2,65



Extensión para DSL800



Descripción	Unds.	Código	EAN	P.V.P. (€)
Set mango extensor	1	199937-7	0088381549370	187,00

Empuñaduras

1

2



Modelo	Tipo	Descripción	Unds.	Código	EAN	P.V.P. (€)
GV7000C PV7000C	1	Empuñadura	1	152491-2	0088381131605	2,50
9227CB	2	Asa	1	416348-4	0088381201193	11,10
9237CB	2	Asa	1	455293-8		25,00
PO6000C	1	Empuñadura	1	198043-5	0088381473033	9,40
DPO600	1	Empuñadura	1	144163-3	0088381523769	3,50

Soporte de lija para 9032



Descripción	Modelo	Unds.	Código	EAN	P.V.P. (€)
Soporte de lija 6 mm	9032	1	125157-7	0088381164009	63,00
Soporte de lija 9 mm		1	125158-5	0088381164016	35,00
Soporte de lija 13 mm		1	125159-3	0088381164023	86,00

Protectores de plástico



Modelo	Descripción	Unds.	Código	EAN	P.V.P. (€)
9565CLR	Protector de plástico	1	417322-5	0088381156981	8,10
9227CB		1	417671-0	0088381169424	18,00
9237CB		1	455291-2	-	9,40
SA5040C		1	453378-4	0088381538480	10,40
SA7000C		1	418529-6	0088381191975	3,20

Protector de polvo 9237C



Modelo	Descripción	Unds.	Código	EAN	P.V.P. (€)
9237C	Evita la entrada de partículas gruesas en el motor	1	455288-1	3240890404909	3,05

Accesorios para pulidoras



Modelo	Tipo	Descripción	Unds.	Código	EAN	P.V.P. (€)
9227CB PV7000C SA7000C	A	Centrador para accesorios de velcro	1	262542-4	0088381142915	2,35

Soporte vertical



Modelos	Unds.	Código	EAN	P.V.P. (€)
9032	1	193618-5	0088381173988	35,00



Mordazas de apriete



Modelos	Unds.	Código	EAN	P.V.P. (€)
9910 9911	2	192694-6	0088381145626	43,00

Nivelador



Modelos	Unds.	Código	EAN	P.V.P. (€)
9902 9903	1	193070-7	0088381154369	101,00
9404	1	193072-3	0088381154383	102,00

Soporte



Modelos	Unds.	Código	EAN	P.V.P. (€)
9402 9401	1	342332-2	0088381116350	4,10

Bolsa recoge polvo para lijadoras de banda



Modelos	Unds.	Código	EAN	P.V.P. (€)
9402	1	122297-2	0088381116299	11,60
9403	1	122562-9	0088381148184	14,10
9404 9920	1	122591-2	0088381154239	12,70
9911	1	122548-3	0088381146784	5,80
9924DB	1	122296-4	0088381116282	14,10

Soporte con guía lateral



Modelos	Unds.	Código	EAN	P.V.P. (€)
9903 - 9920 - 9404	1	193055-3	0088381151955	87,00
9924DB	1	STEX122299	0088381116336	112,00

Desviador de aire para 9402



Modelos	Unds.	Código	EAN	P.V.P. (€)
9402	1	503174	-	14,90



Multiherramienta

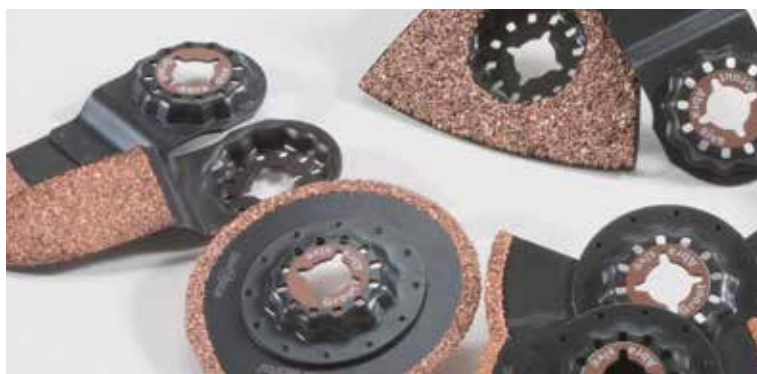

Accesorios multiherrameinta - Gama Starlock

STARLOCK



	Nombre	Medida (mm)	Dientes por pulgada	Material	Diente curvo	Madera					Metal			
						Madera	Contrachapado	Agglomerado	Laminado	Tablero de escayola	Metal no ferroso	Chapa metálica	Inoxidable	Metal blando
	TMA064	85	18	BiM		✓	✓	✓	✓	✓	✓	✓		✓
	TMA046	100	15	BiM		✓	✓	✓	✓	✓	✓			✓
	TMA049	85	18	HCS		✓	✓	✓	✓					
	TMA045	85	18	BiM		✓	✓	✓	✓	✓	✓	✓		✓
	TMA048	65 x 40	20	BiM	✓	✓	✓	✓	✓	✓	✓	✓		✓
	TMA052	65 x 40	20	HCS	✓	✓	✓	✓						
	TMA047	32 x 50	20	BiM	✓	✓	✓	✓	✓	✓	✓	✓		✓
	TMA051	32 x 50	18	HCS	✓	✓	✓	✓						
	TMA055	65 x 40	14	BiM	✓	✓	✓	✓	✓					
	TMA056	65 x 40	14	HCS	✓	✓	✓							
	TMA053	32 x 50	14	BiM	✓	✓	✓	✓	✓					
	TMA050	24 x 50	18	HCS		✓	✓	✓	✓					
	TMA058	20 x 30	20	BiM		✓	✓	✓	✓	✓	✓	✓		✓
	TMA061	32 x 40	23	TC / HM		✓	✓	✓	✓	✓	✓	✓	✓	✓
	TMA059	32 x 50	20	BiM		✓	✓	✓	✓	✓	✓	✓		✓
		TMA057	10 x 30	20	HCS		✓	✓	✓	✓	✓	✓	✓	
TMA060		20 x 40	23	TC / HM		✓	✓	✓	✓	✓	✓	✓	✓	✓
TMA054		32 x 50	14	HCS	✓	✓	✓							
		TMA065	52 x 26	-	HCS									
	TMA066	52 x 40	-	HCS										
	TMA063	100	-	BiM										
	TMA067	28 x 40	-	HCS										
	TMA068	11 x 24	-	HCS										
	TMA075	32 x 30	-	TC # 50		✓				✓				
	TMA076	32 x 50	-	TC # 40		✓	✓							
	TMA077	32 x 50	-	TC # 100		✓	✓							
	TMA074	70	-	TC # 40						✓				
	TMA069	85	-	TC # 30						✓				
	TMA070	85	-	TC # 40						✓				
	TMA071	70	-	TC # 50						✓				
	TMA072	85	-	TC # 40						✓				
	TMA073	78	-	TC # 20		✓								



Multimaterial						Abrasivo		
Epoxy	Fibra de vidrio	Linóleo	Adhesivos	Material de aislamiento	Material de junta suave	Ladrillo blando	Azulejos	Adhesivos y mortertos
✓	✓							
✓	✓							
✓								
✓	✓							
✓	✓							
✓	✓							
✓	✓							
✓	✓							
✓	✓							
✓	✓							
✓	✓							
✓	✓							
✓	✓							
✓	✓							
			✓					
			✓					
		✓	✓	✓				
					✓			
		✓	✓	✓				
✓	✓					✓	✓	✓
✓	✓					✓		✓
✓	✓					✓	✓	✓
✓	✓					✓	✓	✓
✓	✓					✓	✓	✓
✓	✓					✓	✓	✓
✓								✓



Accesorios multiherrameinta - Gama Starlock Máx

STARLOCK MAX



	Nombre	Medida (mm)	Dientes por pulgada	Material cuchilla	Diente Curvo	Madera					Metal			
						Madera	Contra-chapado	Aglome-rado	Laminado	Tablero de escayola	Metal no ferroso	Chapa metálica	Inoxidable	Metal blando
	MAM003	100	15	BiM		✓	✓	✓	✓		✓			✓
	MAM011	68	-	Diamante						✓				
	MAM009	68	-	TC # 50						✓				
	MAM010	68	-	TC # 30						✓				
	MAM014	100	-	TC # 40		✓	✓			✓	✓			✓
	MAM005	32	23	TC		✓	✓	✓	✓	✓	✓	✓	✓	✓
	MAM006	32	20	TC	✓	✓	✓	✓	✓	✓	✓	✓	✓	✓
	MAM004	32	18	HCS	✓	✓	✓	✓	✓					
	MAM001	32	20	BiM	✓	✓	✓	✓	✓	✓	✓	✓		✓
	MAM002	52	18	BiM	✓	✓	✓	✓	✓	✓	✓	✓		✓
	MAM008	32	-	HCS										
	MAM007	32	-	HCS										
	MAM015	116	-	TC # 20		✓	✓	✓						
	MAM017	116	-	TC # 60		✓	✓	✓						



Multimaterial						Abrasivo		
Epoxy	Fibra de vidrio	Linóleo	Adhesivos	Material de aislamiento	Material de junta suave	Ladrillo blando	Azulejos	Adhesivos y morteros
✓								
✓	✓					✓	✓	✓
✓	✓					✓	✓	✓
✓	✓					✓	✓	✓
✓	✓					✓		✓
✓	✓					✓		
✓	✓					✓		
✓	✓							
✓	✓							
				✓	✓			
					✓			
	✓							✓



Accesorios de corte



Cuchilla de corte segmentada 85 STARLOCK

TMA064



- Metales no ferrosos, FRP, PVC.
- Adecuado para esquinas.
- Corte por inmersión en placas de yeso o de fibra de cemento.
- Realizar cajeados en fibra de vidrio (PRFV) / epoxy

Ø (mm)	Material / Indicado para	Unds.	Código	EAN	P.V.P. (€)
85	BiM - TIN / Multimaterial	1	B-64973	0088381536479	25,00

Cuchilla de corte segmentada 100 STARLOCK

TMA046



- Madera y metal.
- Indicado para cortes profundos a ras.
- Marcos de puertas.
- Parquet / suelo laminado.

Ø (mm)	Material / Indicado para	Unds.	Código	EAN	P.V.P. (€)
100	BiM / Madera y Metal	1	B-64808	0088381536301	26,00

Cuchilla de corte segmentada 85 STARLOCK

TMA049



- Cortes de inmersión en madera sólida.
- Indicado para cortes a ras.
- Tubo de PVC.

Ø (mm)	Material / Indicado para	Unds.	Código	EAN	P.V.P. (€)
85	HCS / Madera	1	B-64836	0088381536332	15,40

Cuchilla de corte segmentada 85 STARLOCK

TMA045



- Madera y metal.
- Indicado para cortes profundos a ras.
- Marcos de puertas.
- Parquet / suelo laminado.

Ø (mm)	Material / Indicado para	Unds.	Código	EAN	P.V.P. (€)
85	BiM / Madera y Metal	1	B-64799	0088381536295	18,20

Accesorios de corte de inmersión



Cuchilla de inmersión 65 STARLOCK

TMA048



- Madera y clavos.
- Marcos de puerta.
- Cortes por inmersión en paneles laminados.

Tamaño (mm)	Material / Indicado para	Unds.	Código	EAN	P.V.P. (€)
65 x 40	BiM / Madera y Metal	1	B-64820	0088381536325	19,30

Cuchilla de inmersión 65 STARLOCK

TMA052



- Madera y metal.
- Indicado para corte a ras.
- Parquet / suelo laminado.
- Cortes de inmersión en madera.

Tamaño (mm)	Material / Indicado para	Unds.	Código	EAN	P.V.P. (€)
65 x 40	HCS / Madera	1	B-64864	0088381536363	14,30

Cuchilla de inmersión 32 STARLOCK

TMA047



- Madera y metal.
- Adecuado para corte por inmersión precisa.
- Corte por inmersión en madera dura.

Tamaño (mm)	Material / Indicado para	Unds.	Código	EAN	P.V.P. (€)
32 x 50	BiM / Madera y Metal	1	B-64814	0088381536318	13,80
32 x 50	BiM / Madera y Metal (20 Unds.)	20	B-64814-20	0088381541213	226,00

Cuchilla de inmersión 32 STARLOCK

TMA051



- Cajeados en muebles.
- Cortes profundos en madera blanda.
- Cortes de inmersión en madera blanda.

Tamaño (mm)	Material / Indicado para	Unds.	Código	EAN	P.V.P. (€)
32 x 50	HCS / Madera	1	B-64858	0088381536356	12,10
32 x 50	HCS / Madera (20 Unds.)	20	B-64858-20	0088381541220	139,00

Accesorios de corte de inmersión

Cuchilla de inmersión 65



TMA055



- Cajeados en muebles.
- Cortes al ras.
- Corte de inmersión en paneles laminados o madera dura.



Tamaño (mm)	Material / Indicado para	Unds.	Código	EAN	P.V.P. (€)
65 x 40	BiM / Madera	1	B-64892	0088381536394	18,70

Cuchilla de inmersión 65



TMA056



- Cajeados en muebles.
- Cortes al ras.
- Corte de inmersión en paneles laminados o madera.



Tamaño (mm)	Material / Indicado para	Unds.	Código	EAN	P.V.P. (€)
65 x 40	HCS / Madera	1	B-64901	0088381536400	15,40

Cuchilla de inmersión 32



TMA053



- Madera dura.
- Cajeados en muebles.
- Cortes de inmersión en madera dura y paneles laminados.



Tamaño (mm)	Material / Indicado para	Unds.	Código	EAN	P.V.P. (€)
32 x 50	BiM / Madera	1	B-64870	0088381536370	12,40
32 X 50	BiM / Madera	5	B-64870-5	0088381536684	62,00
32 x 50	BiM / Madera	20	B-64870-20	0088381541237	226,00

Cuchilla de inmersión 24



TMA050



- Cajeados en muebles.
- Cortes al ras en madera. Cortes profundos en madera blanda.
- Cortes de inmersión en madera blanda.



Tamaño (mm)	Material / Indicado para	Unds.	Código	EAN	P.V.P. (€)
24 x 50	HCS / Madera	1	B-64842	0088381536349	8,60
24 x 50	HCS / Madera	5	B-64842-5	0088381588409	43,00



Cuchilla de inmersión 20



TMA058



- Metal. Adecuado para corte al ras en clavos o tubo de cobre.
- Cortes en zócalos.



Tamaño (mm)	Material / Indicado para	Unds.	Código	EAN	P.V.P. (€)
20 x 30	BiM / Metal	1	B-64923	0088381536424	9,40

Cuchilla de inmersión 32



TMA061



- Corte de acero inoxidable.
- Adecuado para corte al ras en tornillos y clavos endurecidos.
- Corte de fibra de vidrio.



Tamaño (mm)	Material / Indicado para	Unds.	Código	EAN	P.V.P. (€)
32 x 40	TC / HM, Metal	1	B-64951	0088381536455	25,00

Cuchilla de inmersión 32



TMA059



- Cortes en zócalos.
- Metal. Adecuado para corte al ras en clavos o tubo de cobre.



Tamaño (mm)	Material / Indicado para	Unds.	Código	EAN	P.V.P. (€)
32 x 50	BiM / Metal	1	B-64939	0088381536431	12,10

Cuchilla de inmersión 10



TMA057



- Metal. Adecuado para corte al ras en clavos.
- Cortes de inmersión en placas de yeso.
- Cortes en zócalos.



Tamaño (mm)	Material / Indicado para	Unds.	Código	EAN	P.V.P. (€)
10 x 30	HCS / Madera	1	B-64917	0088381536417	8,20



Cuchilla de inmersión 20



TMA060



- Corte de acero inoxidable.
- Adecuado para corte al ras en tornillos y clavos endurecidos.
- Corte de fibra de vidrio.

Tamaño (mm)	Material / Indicado para	Unds.	Código	EAN	P.V.P. (€)
20 x 40	TC / HM, Metal	1	B-64945	0088381536448	21,00

Cuchilla de inmersión 32



TMA054



- Cajeados en muebles.
- Cortes de inmersión en madera.

Tamaño (mm)	Material / Indicado para	Unds.	Código	EAN	P.V.P. (€)
32 x 50	HCS / Madera	1	B-64886	0088381536387	12,10

Rascadores



Rascador rígido 52



TMA065



- Retirar restos de moqueta, lechada...
- Eliminación de residuos: Adhesivo, mortero y hormigón.

Tamaño (mm)	Material / Indicado para	Unds.	Código	EAN	P.V.P. (€)
52 x 26	HCS	1	B-64989	0088381536486	9,60

Rascador flexible 52



TMA066



- Eliminación de residuos de pintura.
- Retirar juntas de silicona.
- Eliminación de residuos de adhesivos de alfombras.

Tamaño (mm)	Material / Indicado para	Unds.	Código	EAN	P.V.P. (€)
52 x 40	HCS	1	B-64995	0088381536493	9,90

Cuchillas de corte



Cuchilla segmentada de sierra 100



TMA063



- Ideal para materiales de aislamiento.
- Corte de poliestireno a ras.
- Cortar materiales blandos (moqueta, cuero...)

Ø (mm)	Material / Indicado para	Unds.	Código	EAN	P.V.P. (€)
100	BiM	1	B-64967	0088381536462	25,00

Cuchilla de corte 28



TMA067



- Cortar juntas de expansión blandas.
- Retirar silicona de ventanas.
- Recortar material aislante.

Tamaño (mm)	Material / Indicado para	Unds.	Código	EAN	P.V.P. (€)
28 x 40	HCS	1	B-65006	0088381536509	17,10

Cuchilla universal multicorte 11



TMA068



- Cortar juntas de expansión blandas.
- Retirar silicona de ventanas.
- Recortar material aislante.

Tamaño (mm)	Material / Indicado para	Unds.	Código	EAN	P.V.P. (€)
11 x 24	HCS	1	B-65012	0088381536516	18,20



Limpeza y corte



Cuchilla de limpeza HM 32



TMA075



Corte por inmersión y raspado en fibra de vidrio.

- Eliminar las lechadas en esquinas estrechas o juntas de cemento.

Tamaño (mm)	Material / Indicado para	Unds.	Código	EAN	P.V.P. (€)
32 x 30	TC / HM Grano 50	1	B-65084	0088381536585	25,00

Cuchilla de limpeza HM 32



TMA076



- Lijado de barniz o pinturas en zonas de difícil acceso.
- Lijado de madera, compuesto de madera-plástico y epoxy.

Tamaño (mm)	Material / Indicado para	Unds.	Código	EAN	P.V.P. (€)
32 x 50	TC / HM Grano 40	1	B-65090	0088381536592	22,00

Cuchilla de limpeza HM 32



TMA077



- Lijado de barniz o pinturas en zonas de difícil acceso.
- Lijado de madera, compuesto de madera-plástico y epoxy.

Tamaño (mm)	Material / Indicado para	Unds.	Código	EAN	P.V.P. (€)
32 x 50	TC / HM Grano 100	1	B-65109	0088381536608	22,00

Cuchilla de limpeza HM



TMA074



- Para levantar mortero.
- Limpiar las juntas de los azulejos de suelo.
- Limpieza de juntas de esquinas con la punta de carburo de tungsteno.

Tamaño (mm)	Material / Indicado para	Unds.	Código	EAN	P.V.P. (€)
70	TC / HM Grano 40	1	B-65078	0088381536578	39,00

Cuchilla de limpeza HM 85



TMA069



- Limpieza de juntas en pared y suelo.
- Pequeños cortes en azulejo blando.
- Realizar rozas en hormigón poroso para cables y tuberías.

Ø (mm)	Material / Indicado para	Unds.	Código	EAN	P.V.P. (€)
85	TC / HM Grano 40	1	B-65028	0088381536523	28,00

Cuchilla de corte y limpeza diamante segmentada HM 85



TMA070



- Pequeños cortes en azulejo blando.
- Realizar rozas en epoxy, fibra de vidrio, pvc, porcelánico.

Ø (mm)	Material / Indicado para	Unds.	Código	EAN	P.V.P. (€)
85	TC / HM Grano 40	1	B-65034	0088381536530	45,00

Cuchilla de corte y limpeza segmentada HM 70



TMA071



- Limpieza de juntas en pared y suelo.
- Pequeños cortes en azulejo blando.
- Realizar rozas en hormigón poroso para cables y tuberías.

Ø (mm)	Material / Indicado para	Unds.	Código	EAN	P.V.P. (€)
70	TC / HM Grano 50	1	B-65040	0088381536547	25,00

Cuchilla de corte y limpeza segmentada HM 85



TMA072



- Limpieza de juntas en pared y suelo.
- Pequeños cortes en azulejo blando.
- Realizar rozas en hormigón poroso.

Ø (mm)	Material / Indicado para	Unds.	Código	EAN	P.V.P. (€)
85	TC / HM Grano 40	1	B-65056	0088381536554	24,00



Cuchilla de limpieza

Cuchilla de limpieza TC HM 78 STARLOCK

TMA073



- Retirar mortero o cola de azulejo.
- Limpiar adhesivo de las alfombras.

Tamaño (mm)	Material / Indicado para	Unds.	Código	EAN	P.V.P. (€)
78	TC / HM Grano 20	1	B-65062	0088381536561	24,00

Plato de lija 93

STARLOCK

TMA078



Tamaño (mm)	Material / Indicado para	Unds.	Código	EAN	P.V.P. (€)
93	Velcro	1	B-65115	0088381536615	12,10

Set de cuchillas

Set de cuchillas de inmersión

TMA045 Cuchilla de corte segmentada

TMA047 Cuchilla de inmersión 32

TMA053 Cuchilla de inmersión 32

TMA058 Cuchilla de inmersión 20



Tamaño (mm)	Material / Indicado para	Unds.	Código	EAN	P.V.P. (€)
-	Cortes por inmersión	4	B-67480	0088381541145	48,00

Set de cuchillas para azulejo

TMA058 Cuchilla de inmersión 20

TMA065 Rascador rígido 52

TMA069 Cuchilla de limpieza HM 85

TMA073 Cuchilla de limpieza TC HM 78



Tamaño (mm)	Material / Indicado para	Unds.	Código	EAN	P.V.P. (€)
-	Azulejo	4	B-67496	0088381541152	58,00



Tabla de aplicación - Lijas para multiherramienta

		Grano	Pintura	Barniz	Lacas	Yeso	Madera	Madera blanda	Madera dura	Contrachapado de madera	Aglomerado / MDF	Fibra de vidrio / Plásticos	Metal	Acero	Piedra	Mármol	Granito	Vidrio	Metacrilato	
Madera / long life	Grueso	60																		
		80																		
	Medio	100	-	-	-	-	✓✓	✓✓	✓✓	✓✓	✓	✓✓	✓	-	-	-	-	-	-	
		120																		
		180																		
Fino	240																			
Madera	Grueso	60																		
		80																		
	Medio	100	-	-	-	-	✓✓	✓	✓✓	✓✓	✓	-	-	-	-	-	-	-	-	
		120																		
		150																		
Fino	180																			
	240																			
Pintura	Grueso	60																		
		80																		
	Medio	100	✓✓	✓✓	✓✓	✓✓	-	-	✓	-	-	✓	✓	-	-	-	-	-	-	
		120																		
		240																		
Fino	320																			
Piedra	Medio	120																		
		240																		
	Fino	400	✓	✓✓	-	-	-	-	-	-	✓	-	-	✓	✓	✓	✓	✓	✓	
		600																		
		1200																		



Lijas

Lijas para madera

- Adecuado para lijar madera, madera dura, aglomerado, tableros de construcción y metal.



Medida (mm)	Tipo	Grano	Unds.	Código	EAN	P.V.P. (€)
93 x 93 x 93	Madera	60	10	B-21624	0088381401081	3,90
		80	10	B-21630	0088381401098	3,60
		100	10	B-22947	0088381403344	3,60
		120	10	B-21646	0088381401104	3,60
		150	10	B-22953	0088381403351	3,60
		180	10	B-21652	0088381401111	3,60
		240	10	B-21668	0088381401128	3,60
		60, 80, 120, 180, 240	10 (2 de cada)	B-21618	0088381401074	4,20

Lijas para pintura y barniz

- Adecuado para lijar pintura, barniz o desbaste.



Medida (mm)	Tipo	Grano	Unds.	Código	EAN	P.V.P. (€)
93 x 93 x 93	Pintura	60	10	B-21680	0088381401142	4,10
		80	10	B-21696	0088381401159	4,10
		100	10	B-21705	0088381401166	4,10
		120	10	B-22969	0088381403368	4,10
		240	10	B-21711	0088381401173	4,10
		320	10	B-21727	0088381401180	4,10
		60, 80, 100, 240, 320	10 (2 de cada)	B-21674	0088381401135	4,40

Abrasivo de lana para eliminar óxido del metal y la suciedad de la madera

- Adecuado para eliminar el óxido del metal y la suciedad de la madera.



Medida (mm)	Tipo	Grano	Unds.	Código	EAN	P.V.P. (€)
93 x 93 x 93	Lana	100	1	B-21808	0088381401265	3,30
		280	1	B-21799	0088381401258	3,30
		Sin grano	1	B-21814	0088381401272	3,30

Kit de aspiración



Modelo	Unds.	Código	EAN	P.V.P. (€)
TM3000C	1	199618-3	0088381545303	7,00
TM3010C	1	199624-8	0088381545297	8,80
DTM51	1	199627-2	0088381545327	11,50
DTM52	1	191R02-6	0088381580564	12,00

Lijas para madera dura, tableros de obra y metal

- Adecuado para trabajos en madera, plástico, metal en planchas, maderas barnizadas y metales pintados.



Medida (mm)	Tipo	Grano	Unds.	Código	EAN	P.V.P. (€)
93 x 93 x 93	Madera dura	40	10	P-33255	0088381961417	4,10
		60	10	P-33261	0088381961424	4,10
		80	10	P-33277	0088381961431	4,10
		100	10	P-33283	0088381961448	3,90
		120	10	P-33299	0088381961455	3,90
		180	10	P-33314	0088381961479	3,90
		240	10	P-33320	0088381961486	3,90
		60, 80, 100, 120, 180	10 (2 de cada)	B-21559	0088381401012	4,40

Lijas para materiales duros como piedra, mármol o cristal

- Adecuado para el lijado grueso o brillante de materiales duros como piedra, mármol o cristal.



Medida (mm)	Tipo	Grano	Unds.	Código	EAN	P.V.P. (€)
93 x 93 x 93	Piedra	120	10	B-21749	0088381401203	4,10
		240	10	B-21755	0088381401210	4,10
		400	10	B-21761	0088381401227	4,10
		600	10	B-21777	0088381401234	3,90
		1200	10	B-21783	0088381401241	3,90
		120, 240, 400, 600, 1200	10 (2 de cada)	B-21733	0088381401197	4,40

Filtro para el pulido previo de superficies sucias o ralladas

- Filtro para el pulido previo de superficies sucias o ralladas.



Medida (mm)	Tipo	Grano	Unds.	Código	EAN	P.V.P. (€)
93 x 93 x 93	Filtro	Duro	1	B-21820	0088381401289	3,30

Adaptador universal



Unds.	Código	EAN	P.V.P. (€)
1	313248-8	0088381416528	2,80



STARLOCK MAX



Accesorios de corte

C. de corte segmentada 100 STARLOCK MAX

MAM003



- Adecuada para cortes rectos largos, cortes profundos y anchos en madera y metal.
- También puede cortar epoxy y fibra de vidrio.

Tamaño (mm)	Material / Indicado para	Unds.	Código	EAN	P.V.P. (€)
100 x 50	BiM / Madera y metal	1	B-66422	0088381539326	25,00

Accesorios de corte de inmersión



Cuchilla de inmersión curva 32 STARLOCK MAX

MAM006



- Adecuado para corte de inmersión con precisión, corte profundo y rápido en multimaterial.
- También puede cortar madera, epoxy, fibra de vidrio y hormigón poroso.

Tamaño (mm)	Material / Indicado para	Unds.	Código	EAN	P.V.P. (€)
32 x 70	TC / HM, Multimaterial	1	B-66450	0088381539357	26,00

Cuchilla de inmersión 32 STARLOCK MAX

STARLOCK MAX

MAM005



- Adecuado para corte de inmersión, corte profundo y rápido en metal.
- También puede cortar epoxy, fibra de vidrio, hormigón poroso y madera.

Tamaño (mm)	Material / Indicado para	Unds.	Código	EAN	P.V.P. (€)
32 x 70	TC / HM, Metal	1	B-66444	0088381539340	25,00

Cuchilla de inmersión curva 32 STARLOCK MAX

MAM004



- Adecuado para corte de inmersión precisa, corte profundo y rápido en madera.
- No se puede usar para cortar otros materiales.

Tamaño (mm)	Material / Indicado para	Unds.	Código	EAN	P.V.P. (€)
32 x 80	HCS / Madera	1	B-66438	0088381539333	10,80

Cuchilla de inmersión curva 52 STARLOCK MAX

MAM002



- Adecuada para corte de inmersión con precisión, corte profundo y ancho especialmente en madera y metal.
- También puede cortar epoxy y fibra de vidrio.

Tamaño (mm)	Material / Indicado para	Unds.	Código	EAN	P.V.P. (€)
52 x 70	BiM / Madera y metal	1	B-66416	0088381539319	14,90

Cuchilla de inmersión curva 32 STARLOCK MAX

MAM001



- Adecuada para corte de inmersión con precisión, corte profundo y rápido especialmente en madera y metal.
- También puede cortar epoxy y fibra de vidrio.

Tamaño (mm)	Material / Indicado para	Unds.	Código	EAN	P.V.P. (€)
32 x 80	BiM / Madera y metal	1	B-66400	0088381539302	13,80

Cuchillas de corte de juntas



Cuchilla de corte de juntas 32 STARLOCK MAX

MAM008



- Adecuada para corte de juntas blandas, corte profundo y ancho.
- No es posible cortar en otro material.

Tamaño (mm)	Material / Indicado para	Unds.	Código	EAN	P.V.P. (€)
32 x 55	HCS / Juntas blandas	1	B-66472	0088381539371	7,20



Cuchilla de corte de juntas 32 STARLOCK MAX

MAM007



- Adecuada para corte de juntas blandas, corte profundo y rápido.
- No es posible cortar otros materiales.

Tamaño (mm)	Material / Indicado para	Unds.	Código	EAN	P.V.P. (€)
32 x 70	HCS / Juntas blandas	1	B-66466	0088381539364	14,30

Cuchillas de diamante



C. de corte segmentada 68 STARLOCK MAX

MAM011



- Adecuada para el recorte de baldosas de pared blandas.
- También puede cortar yeso, epoxy y fibra de vidrio.

Tamaño (mm)	Material / Indicado para	Unds.	Código	EAN	P.V.P. (€)
68 x 30	Diamante Grano 40, corte de baldosas y azulejos de pared	1	B-66519	0088381539418	41,00



Cuchillas de corte para azulejos



C. de corte segmentada 68 STARLOCK MAX

MAM009



- Adecuada para cortar juntas en azulejos de pared.
- También puede cortar en cartón yeso, epoxy y fibra de vidrio.

Tamaño (mm)	Material / Indicado para	Unds.	Código	EAN	P.V.P. (€)
68 x 10	TC/HM Grano 50, juntas de azulejos de pared	1	B-66494	0088381539395	30,00

C. de corte segmentada 68 STARLOCK MAX

MAM010



- Adecuado para el corte de juntas en azulejos de pared.
- Capaz de cortar otros materiales como cartón yeso, epoxy, fibra de vidrio.

Tamaño (mm)	Material / Indicado para	Unds.	Código	EAN	P.V.P. (€)
68 x 30	TC/HM Grano 30, juntas de azulejos de pared	1	B-66503	0088381539401	30,00

C. de corte segmentada 100 STARLOCK MAX

MAM014



- Adecuada para cortar juntas en azulejos de pared.
- También se puede cortar en madera, epoxy y fibra de vidrio.

Tamaño (mm)	Material / Indicado para	Unds.	Código	EAN	P.V.P. (€)
100 x 50	TC / HM Grano 40, juntas de azulejos de pared	1	B-66547	0088381539449	29,00



Limpieza y corte



Cuchilla de limpieza 116 STARLOCK MAX

MAM015



- Adecuada para limpiar azulejos de pared.
- También puede limpiar madera y fibra de vidrio.

Ø (mm)	Material / Indicado para	Unds.	Código	EAN	P.V.P. (€)
116	TC/HM Grano 20, limpieza de azulejos	1	B-66553	0088381539456	22,00



Cuchilla de limpieza 116 STARLOCK MAX

MAM017



- Adecuada para limpiar madera.
- También puede limpiar derivados de madera.

Ø (mm)	Material / Indicado para	Unds.	Código	EAN	P.V.P. (€)
116	TC / HM Grano 60, limpieza de madera	1	B-66575	0088381539470	22,00

Sierras

- Circulares
- Ingletadoras
- Incisión



MFORCE

SSPECIALIZED

EFFICUT



Tipos de dentado

ATB

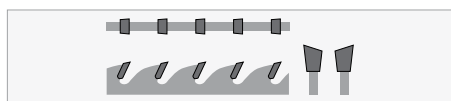
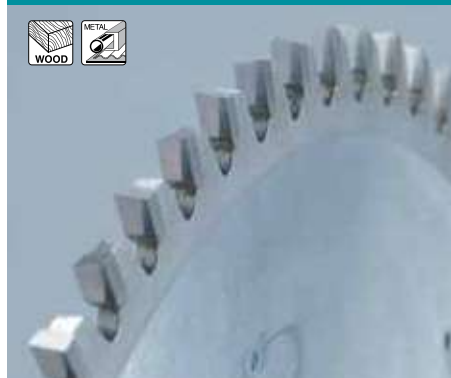

ATAF

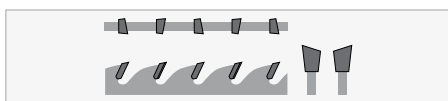

M-FORCE

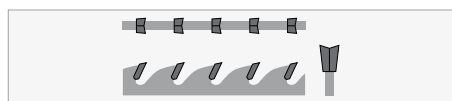

FTG

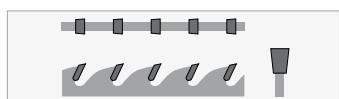

TCG

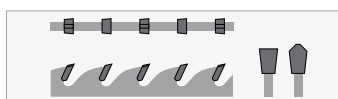

SMTCG

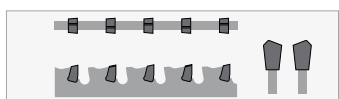

HI - ATB

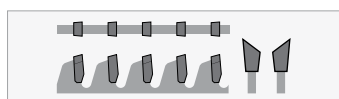
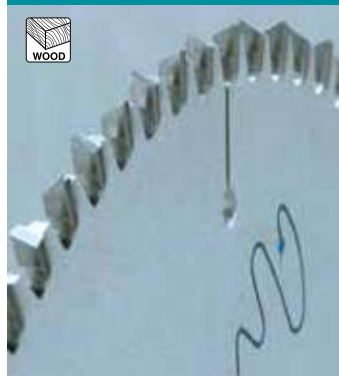

Tecnología

Hendidura láser

Láser slit

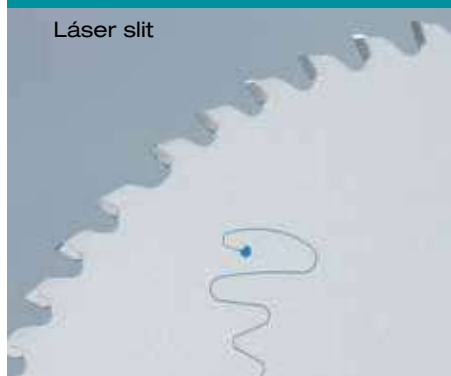

Reduce el ruido y las vibraciones.

Recubierto























Recubierto de PTFE (politetrafluoroetileno) que reduce la acumulación de suciedad y baja la resistencia sobre el material.













Reforzado



El diseño de diente embutido incrementa la superficie de agarre para soportar trabajos más duros.

Tipos de discos para sierras circulares, ingletadoras y sierras de incisión

			85mm	136mm	165mm	185mm	190mm	210mm	235mm	270mm	355mm
MAKFORCE			-	-	160mm	170mm	180mm	230mm	✓	✓	✓
SPECIALIZED REFORZADO			-	-	✓	✓	✓	✓	✓	✓	✓
MFORCE			-	-	✓	✓	-	-	✓	-	-
SPECIALIZED STANDARD			-	-	✓	✓	-	✓	✓	-	-
SPECIALIZED STANDARD economy			-	-	✓	✓	✓	-	✓	-	-
SPECIALIZED ALUMINIO			-	-	160mm	-	✓	✓	✓	-	360mm
SPECIALIZED CONSTRUCCION			-	-	-	-	✓	✓	✓	-	-
SPECIALIZED PANEL SANDWICH			-	-	✓	-	-	-	✓	✓	✓
SPECIALIZED MAQUINAS DE BATERIA			✓	✓	✓	-	✓	-	✓	-	-
SPECIALIZED INCISION			-	-	160mm	-	-	-	-	-	-

			136mm	165mm	190mm	216mm	250mm	260mm	300mm	305mm	315mm
MAKBLADE PLUS			-	-	✓	-	✓	-	-	-	-
MAKBLADE			-	-	✓	✓	✓	255mm	260mm	✓	-
SPECIALIZED ALUMINIO			-	-	✓	✓	-	✓	-	✓	350mm
SPECIALIZED S. MESA			-	-	-	210 mm	-	✓	-	-	✓
SPECIALIZED S. MESA			-	-	-	-	-	✓	✓	-	350mm
SPECIALIZED LAMINADOS			✓	✓	✓	✓	-	✓	-	✓	-



EFFICUT

IDEAL FOR C...
CIRCUL...

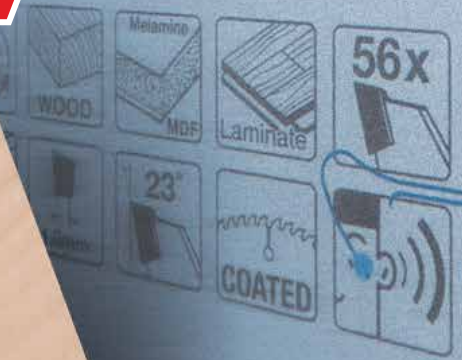

Características del tipo de diente EFFICUT

	<p>Ángulo superior agudo</p>	<p>Permite realizar cortes finos sin esfuerzo.</p>
	<p>Cuerpo curvo</p>	<p>Permite evacuar la viruta de forma muy eficiente.</p>
	<p>Base rectificada</p>	<p>Alarga la vida de la batería al tener que realizar menos esfuerzo en cada corte.</p>

Más cortes por carga

Cortes rápidos

Mayor duración de la batería

Hoja: 1,6 mm **Cantidad de cortes con una carga**

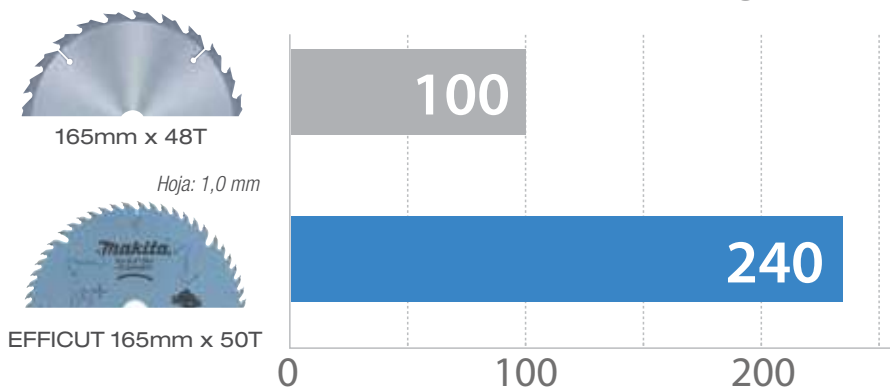

**x2,4
VECES MÁS**

1. Los resultados de la prueba dependen en gran medida de la dureza de la madera, etc.
2. Los gráficos de barras de la cantidad de cortes son valores relativos cuando la capacidad de la hoja actual (grosor: 1,6 mm) es 100.

**CORDELESS
CIRCULAR SAWS**



Discos de sierra para sierras circulares

Discos Makforce



Una extensa selección de discos para todas las marcas y modelos de sierras circulares portátiles.

Amplia gama de medidas, desde 160mm hasta 355mm y de número de dientes desde 12 hasta 60. La gama abarca un gran número de aplicaciones desde corte grueso y corte transversal a corte fino y longitudinal.

- La estructura del disco es de acero tensionado de precisión, absorbe los impactos sin deformarse.
- Carburo de tungsteno de alta calidad y bajo desgaste para una larga vida de la sierra.
- Afilado perfecto para cortes más precisos.
- Corte fino, con menos viruta y menos esfuerzo en el motor.

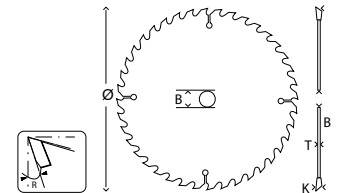

Ø 165mm DHS660 - DHS661 - DHS680 - DSS610 - HS6100 - HS6601

Ø ext. (mm)	Ø int. (mm)	K (mm)	T (mm)	Nº dientes	R	Tipo de diente	Reducción	Código	EAN	P.V.P (€)
160	20	2,4	1,5	16	20°	ATB	15,88	B-32091	0088381420907	20,00
160	20	2,4	1,5	24	20°	ATB	15,88	B-32203	0088381421010	24,00
160	20	2,4	1,5	40	20°	ATB	15,88	B-32297	0088381421102	29,00
165	20	2,4	1,5	10	20°	FTG	-	B-32100	0088381420914	24,00
170	30	2,4	1,5	16	20°	ATB	15,88	B-32122	0088381420938	22,00
170	30	2,4	1,5	24	20°	ATB	15,88	B-32225	0088381421034	25,00
170	30	2,4	1,5	40	20°	ATB	15,88	B-32312	0088381421126	27,00

Ø 190mm DHS710 - DHS782 - DHS783 - HS7601 - HS7100 - HS7101 - M5802B - HS004G

180	20	2,4	1,5	16	20°	ATB	-	B-08187	0088381336178	20,00
180	20	2,4	1,5	24	20°	ATB	-	B-08327	0088381336314	23,00
190	30	2	1,4	12	20°	FTG	20/15,88	B-32144	0088381420952	25,00
190	30	2,2	1,4	24	20°	ATB	20/15,88	B-32247	0088381421058	26,00
190	30	2,2	1,4	40	20°	ATB	20/15,88	B-32340	0088381421157	34,00
190	30	2,2	1,4	60	15°	ATAF	20/15,88	B-32390	0088381421201	37,00

Ø 210mm 5008MG

210	30	2,4	1,6	16	20°	ATB	-	B-32150	0088381420969	25,00
210	30	2,4	1,6	24	20°	ATB	-	B-32253	0088381421065	31,00
210	30	2,4	1,6	40	20°	ATB	-	B-32356	0088381421164	36,00

Ø 235mm 5903R - 5903RK - DHS900 - HS009G

235	30	2,3	1,6	20	20°	ATB	-	B-32269	0088381421072	26,00
235	30	2,6	1,6	40	20°	ATB	-	B-32362	0088381421171	32,00
235	30	2,8	1,8	60	15°	ATAF	-	B-32415	0088381421225	34,00

Ø 270mm 5103R - HS0600 - HS011G

270	30	2,6	1,8	24	20°	ATB	-	B-32172	0088381420983	40,00
270	30	2,6	1,6	40	20°	ATB	-	B-32378	0088381421188	46,00
270	30	2,8	1,8	60	15°	ATAF	-	B-32409	0088381421218	50,00

Ø 355mm 5143R

355	30	3,0	2,2	24	20°	ATB	-	B-32188	0088381420990	56,00
355	30	3,0	2,2	40	20°	ATB	-	B-32281	0088381421096	63,00
355	30	3,0	2,2	60	20°	ATB	-	B-32384	0088381421195	67,00

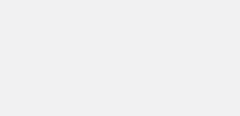
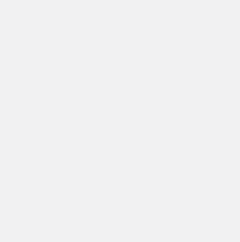

Discos de sierra para sierras circulares

Discos Specialized Reforzado



Diseñados para sierras circulares de Makita y otros fabricantes de sierras, los dientes reforzados o “dientes embutidos” son especialmente resistentes y con bajo desgaste. Para cortes fáciles en maderas con nudos. Diseñado para evitar que salten los dientes cuando se corten clavos en madera accidentalmente.

Especialmente apropiado para la recuperación de madera y de trabajos de demolición.

- Corte en madera con clavos accidentales y nudos.
- Extremadamente resistente y de bajo desgaste.
- Aumentan la vida de la sierra y la productividad.
- Corte fino, con menos viruta y menos esfuerzo en el motor.

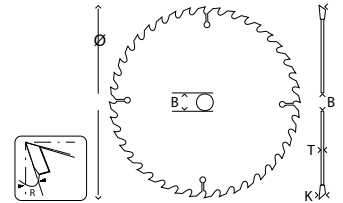

Ø 165mm DHS660 - DHS661 - DHS680 - DSS610 - HS6100 - HS6601

Ø ext. (mm)	Ø int. (mm)	K (mm)	T (mm)	Nº dientes	R	Tipo de diente	Reducción	Código	EAN	P.V.P (€)
165	20	2	1,25	16	23°	ATB Reforzado	-	B-33037	0088381421904	28,00
165	20	2	1,25	24	23°	ATB Reforzado	-	B-33093	0088381421966	32,00
165	20	2	1,25	40	18°	ATB Reforzado	-	B-33168	0088381422031	36,00

Ø 190mm DHS710 - DHS782 - DHS783 - HS7601 - HS7100 - HS7101 - M5802B - HS004G

185	30	2	1,25	16	25°	ATB Reforzado	-	B-33043	0088381421911	22,00
185	30	2	1,25	40	25°	ATB Reforzado	-	B-33174	0088381422048	29,00
190	30	2	1,25	16	23°	ATB Reforzado	-	B-33059	0088381421928	22,00
190	30	2	1,25	24	23°	ATB Reforzado	-	B-33118	0088381421980	31,00
190	30	2	1,25	40	23°	ATB Reforzado	-	B-33180	0088381422055	41,00

Ø 210mm 5008MG

210	30	1,9	1,4	18	23°	ATB Reforzado	-	B-09363	0088381337403	27,00
-----	----	-----	-----	----	-----	---------------	---	---------	---------------	-------

Ø 235mm 5903R - 5903RK - DHS900 - HS009G

235	30	2,3	1,6	24	23°	ATB Reforzado	-	B-33130	0088381422000	33,00
235	30	2,3	1,6	48	18°	ATB Reforzado	-	B-33196	0088381422062	51,00

Ø 270mm 5103R - HS0600 - HS011G

270	30	2,6	1,8	24	23°	ATB Reforzado	-	B-33146	0088381422017	64,00
270	30	2,6	1,8	40	18°	ATB Reforzado	-	B-33205	0088381422079	79,00
270	30	2,6	1,8	60	18°	ATB Reforzado	-	B-33211	0088381422086	80,00

Ø 355mm 5143R

355	30	3	2,2	24	23°	ATB Reforzado	-	B-33087	0088381421959	87,00
355	30	3	2,2	60	18°	ATB Reforzado	-	B-33227	0088381422093	114,00



Discos de sierra para sierras circulares

Discos MForce



Diseño avanzado y revolucionario para sierras circulares.

El diente con doble cara biselada tiene un corte fino y el diseño en "M" hace el efecto del doble diente.

Mayor superficie de corte del diente se traduce en una duración mayor que los discos tradicionales. Un corte y un diente estrecho reduce la fricción consiguiendo así un menor aumento de la corriente, protegiendo el motor de su sierra. Corte en madera con clavos accidentales y nudos.

- Acabado perfecto, ya que el número de dientes en M se multiplica por 2.
- Corte agresivo.
- Área de trabajo más grande.
- Más duradero.

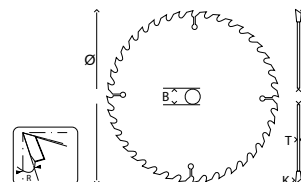

Ø 165mm DHS660 - DHS661 - DHS680 - DSS610 - HS6100 - HS6601

Ø ext. (mm)	Ø int. (mm)	K (mm)	T (mm)	Nº dientes	R	Tipo de diente	Reducción	Código	EAN	P.V.P (€)
165	20	2	1,2	16	15°	M-Force	-	B-31930	0088381420747	15,70
165	20	2	1,2	24	15°	M-Force	-	B-32007	0088381420815	19,20

Ø 190mm DHS710 - DHS782 - DHS783 - HS7601 - HS7100 - HS7101 - M5802B - HS004G

185	30	2	1,2	24	15°	M-Force	20/15,88	B-32035	0088381420846	22,00
-----	----	---	-----	----	-----	---------	----------	---------	---------------	-------

Ø 235mm 5903R - 5903RK - DHS900 - HS009G

235	30	2,3	1,6	40	15°	M-Force	25/15,88	B-32085	0088381420891	34,00
-----	----	-----	-----	----	-----	---------	----------	---------	---------------	-------



Discos Specialized Standard



Diseñados para sierras circulares Makita y otros fabricantes de sierras.

Ø 165mm DHS660 - DHS661 - DHS680 - DSS610 - HS6100 - HS6601

Ø ext. (mm)	Ø int. (mm)	K (mm)	T (mm)	Nº dientes	R	Tipo de diente	Reducción	Código	EAN	P.V.P (€)
165	20	2,4	1,5	10	20°	ATB	-	D-03327	0088381173667	12,30
165	20	2,0	1,5	16	20°	ATB	-	D-09628	0088381184816	13,50
165	20	2,4	1,5	24	20°	ATB	-	D-03333	0088381173674	14,70
165	20	2,4	1,5	40	18°	ATB	-	D-03349	0088381173681	17,80

Ø 190mm DHS710 - DHS782 - DHS783 - HS7601 - HS7100 - HS7101 - M5802B - HS004G

185	30	1,8	1,2	16	20°	ATB	20	D-03903	0088381174336	13,50
185	30	2,0	1,2	20	20°	ATB	30/20	D-09634	0088381184823	14,70
185	30	1,8	1,2	40	18°	ATB	20	D-03919	0088381174343	16,50

Ø 210mm 5008MG

210	30	2,0		24	20°	ATB	-	D-29050	0088381343466	25,00
-----	----	-----	--	----	-----	-----	---	---------	---------------	-------

Ø 235mm 5903R - 5903RK - DHS900 - HS009G

235	30	2,3	1,6	20	20°	ATB	25	D-03925	0088381174350	21,00
235	30	2,3	1,6	48	18°	ATB	25	D-03931	0088381174367	25,00
235	30	2,3	1,6	60	15°	ATB	25	D-09640	0088381184830	31,00



Discos de sierra para sierras circulares

Discos Specialized Standard Economy



- Diseñados para sierras circulares Makita y otros fabricantes de sierras.
- Cortes en maderas blandas.
- Excelente calidad / precio.

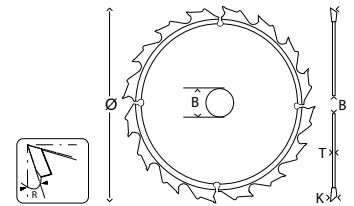

Ø 165mm DHS660 - DHS661 - DHS680 - DSS610 - HS6100 - HS6601

Ø ext. (mm)	Ø int. (mm)	K (mm)	T (mm)	Nº dientes	R	Tipo de diente	Reducción	Código	EAN	P.V.P (€)
165	20	2,0	1,2	16	12°	ATB	-	D-52554	0088381444422	7,70
165	20	2,0	1,2	24	12°	ATB	-	D-52560	0088381444439	9,00
165	20	2,0	1,2	40	12°	ATB	-	D-52576	0088381444446	11,00

Ø 190mm DHS710 - DHS782 - DHS783 - HS7601 - HS7100 - HS7101 - M5802B - HS004G

185	30	2,2	1,4	16	18°	ATB	-	D-52582	0088381444453	9,70
185	30	2,2	1,4	24	15°	ATB	-	D-52598	0088381444460	11,00
185	30	2,2	1,4	40	14°	ATB	-	D-52607	0088381444477	12,30

Ø 190mm DHS710 - DHS782 - DHS783 - HS7601 - HS7100 - HS7101 - M5802B - HS004G

190	30	2,2	1,4	24	15°	ATB	-	D-64951	0088381533096	11,30
190	30	2,2	1,4	40	15°	ATB	-	D-64967	0088381533102	12,90
190	30	2,0	1,4	40	18°	ATB	-	D-64973	0088381533119	15,40

Ø 210mm - 5008MG

210	30	2,5	1,6	24	15°	ATB	-	D-72291	0088381569026	14,00
210	30	2,5	1,6	40	15°	ATB	-	D-72300	0088381569033	15,20

Ø 235mm 5903R - 5903RK - DHS900 - HS009G

235	30	2,5	1,6	20	14°	ATB	-	D-52613	0088381444484	16,70
235	30	2,5	1,6	40	12°	ATB	-	D-52629	0088381444491	19,40
235	30	2,5	1,6	60	12°	ATB	-	D-52635	0088381444507	22,00



Makita



Discos de sierra para sierras circulares

Discos Specialized Aluminio



Amplia gama de discos para sierras circulares con un excelente rendimiento de corte en aluminio, latón, bronce y otros metales no ferrosos. Los discos también son válidos para trabajar en plásticos y maderas laminadas. Aplicar cera de discos en la zona del diente frecuentemente para prevenir la acumulación de viruta en los dientes cuando cortemos metales no ferrosos.

- La estructura del disco es de acero tensionado de precisión para mayor rigidez y cortes más rectos.
- Excelente calidad de corte en materiales no ferrosos.
- Perfecta realización del corte en suelos laminados.

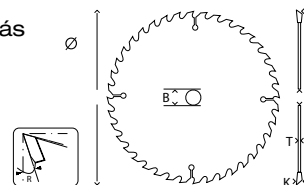

Ø 165mm DHS680 - DHS660 - DHS661 - DSS610 - HS6601 - HS6100

Ø ext. (mm)	Ø int. (mm)	K (mm)	T (mm)	Nº dientes	R	Tipo de diente	Reducción	Código	EAN	P.V.P (€)
160	20	2,4	1,8	60	0°	TCG	-	B-33233	0088381422109	42,00

Ø 190mm DHS710 - DHS782 - DHS783 - HS7601 - HS7100 - HS7101 - M5802B - HS004G

190	30	2,4	1,8	60	0°	TCG	20/15,88	B-33261	0088381422130	59,00
-----	----	-----	-----	----	----	-----	----------	---------	---------------	-------

Ø 210mm 5008MG

210	30	2,8	2	54	-5°	TCG	25	B-33548	0088381422437	59,00
-----	----	-----	---	----	-----	-----	----	---------	---------------	-------

Ø 235mm 5903R - 5903RK - DHS900 - HS009G

235	30	2,4	1,8	80	0°	TCG	-	B-33277	0088381422147	67,00
-----	----	-----	-----	----	----	-----	---	---------	---------------	-------

Ø 350mm

350	30	3,2	2,6	100	0°	TCG	-	B-33401	0088381422284	108,00
-----	----	-----	-----	-----	----	-----	---	---------	---------------	--------



Discos Specialized Construcción



Estos discos están indicados para maderas de construcción, maderas de encofrados, maderas con clavos, maderas prensadas, maderas con residuos de hormigón.

- El diente está embutido dentro del cuerpo del disco, para conseguir una gran resistencia.
- Los dientes pueden ser reafilados para un mayor aprovechamiento del disco.
- Gracias a su estructura reforzada conseguimos cortes rectos sin desviaciones sin necesidad de ninguna guía.

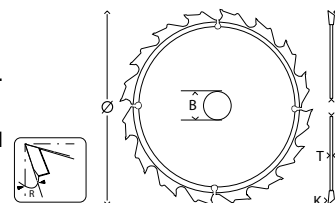

Ø 190mm DHS710 - DHS782 - DHS783 - HS7601 - HS7100 - HS7101 - M5802B - HS004G

Ø ext. (mm)	Ø int. (mm)	K (mm)	T (mm)	Nº dientes	R	Tipo de diente	Reducción	Código	EAN	P.V.P (€)
190	30	2,6	1,6	12	20°	FTG Reforzado	-	B-33554	0088381422444	28,00

Ø 210mm 5008MG

210	30	2,8	1,8	14	20°	FTG Reforzado	-	B-27246	0088381411172	30,00
-----	----	-----	-----	----	-----	---------------	---	---------	---------------	-------

Ø 235mm 5903R - 5903RK - DHS900 - HS009G

235	30	2,8	1,8	16	20°	FTG Reforzado	-	B-13699	0088381359801	34,00
-----	----	-----	-----	----	-----	---------------	---	---------	---------------	-------



Discos de sierra para sierras circulares

Discos Specialized Panel Sandwich



Discos con diente de HM para el corte específico de panel sandwich.

Diente con forma triangular contrapuesto:

- Reduce la rebaba en la pieza.
- Evita la rotura del disco.
- Ranuras para evitar vibración y ruido.

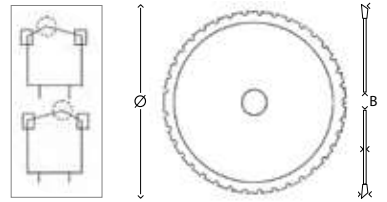

- Ideal para su utilización en nuestros modelos 5903R, 5104S, 5103R y 5143R.
- Larga duración. Muy buen acabado gracias al tipo de diente.



Ø 165mm DHS660 - DHS661 - DSS610 - DHS680 - HS6601 - HS6100										
Ø ext. (mm)	Ø int. (mm)	K (mm)	T (mm)	Nº dientes	R	Tipo de diente	Reducción	Código	EAN	P.V.P (€)
165	20	1,75	1,4	42	0°	SMTCG LaserSlit	-	B-63149		63,00
Ø 235mm 5903R - 5903RK - DHS900 - HS009G										
235	30	2,2	1,8	50	0°	SMTCG LaserSlit	-	B-33582	0088381422475	93,00
Ø 270mm 5103R - HS0600										
270	30	2,4	2	60	0°	SMTCG LaserSlit	-	B-33598	0088381422482	134,00
Ø 355mm 5143R										
355	30	2,6	2,2	80	0°	SMTCG LaserSlit	-	B-33607	0088381422499	162,00

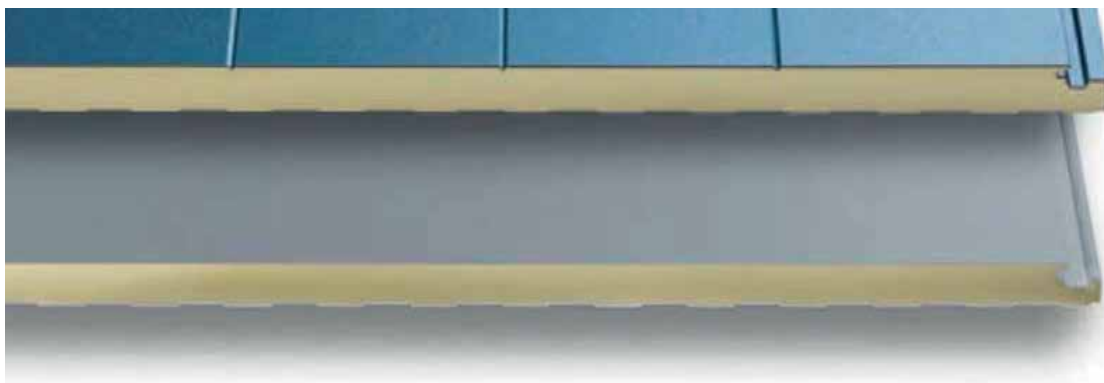

Discos Specialized Batería



Los discos de calidad superior están hechos especialmente para las sierras a batería.

Discos para cortar madera, ahora disponibles para las sierras circulares a batería más populares.

“Todas con la calidad Makita”.

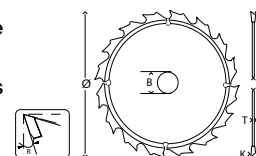

Ø 85mm HS301D

Ø ext. (mm)	Ø int. (mm)	K (mm)	T (mm)	Nº dientes	R	Tipo de diente	Reducción	Código	EAN	P.V.P (€)
85	15	1,0	0,7	20	10°	ATB	Madera	B-14607	0088381362689	10,20
85	15	0,5	0,5	50	-	-	Contrachapado	792299-8	0088381101004	14,30
85	15	0,5	0,5	50	-	-	Plástico	792259-0	0088381100816	11,00

Ø 136mm DSS501

136	20	1,5	1,0	16	20°	ATAF	Madera	B-10643	0088381347815	26,00
-----	----	-----	-----	----	-----	------	--------	---------	---------------	-------

Ø 165mm DHS660 - DHS661 - DSS610 - DHS680

165	20	1,6	1	40	18°	ATAF	Madera	B-32954	0088381421829	27,00
165	20	1,5	1	24	20°	ATAF	Madera	B-32910	0088381421782	25,00
165	20	1,4	1	25	23	Efficut	Madera	B-62979	0088381531474	31,00
165	20	1,45	1	56	23°	Efficut	Madera	B-57336	0088381518420	50,00
165	20	1,5	1	24	15°	Efficut composite	Madera	E-12217	0088381584753	30,00
165	20	1,5	1	40	15°	Efficut composite	Madera	E-12223	0088381584760	43,00

Ø 190mm DHS710 - DHS782 - DHS783 - HS004G

190	30	2	1,4	24	20°	ATAF	Madera	B-32926	0088381421799	22,00
190	30	2	1,4	40	10°	ATAF	Madera	B-32976	0088381421843	26,00
190	20	1,85	1,35	50	8	Efficut composite	Madera	E-12251	0088381584784	61,00
N 190	30	1,5	1	24	23°	Corte limpio	-	B-64185	0088381533881	31,00

Ø 216mm DHS900

216	30	-	-	45	-	-	-	E-06971	0088381570725	48,00
216	30	2	1,5	60	8	Efficut composite	Madera	E-12267	0088381584791	71,00

Ø 235mm DHS900 - HS009G

235	30	2,2	1,5	24	20	Efficut	Madera	E-01909	0088381337236	44,00
-----	----	-----	-----	----	----	---------	--------	---------	---------------	-------

Ø 260mm -

260	30	2,15	1,65	75	8	Efficut composite	Madera	E-12273	0088381572040	80,00
-----	----	------	------	----	---	-------------------	--------	---------	---------------	-------



Makita

Discos de sierra para sierras circulares

Discos Specialized Incisión



Estos discos son específicos para las sierras de incisión.

Están específicamente diseñados para conseguir un corte totalmente limpio.

Los discos para sierras de incisión tienen una tecnología patentada contra las vibraciones.

Los discos de baja vibración ejecutan el corte con menos vibraciones por lo que el disco entra más fácil en el material y con menos esfuerzo.

- La estructura del disco es de acero tensionado de precisión para mayor rigidez y cortes más rectos.
- Válido para cortar madera.

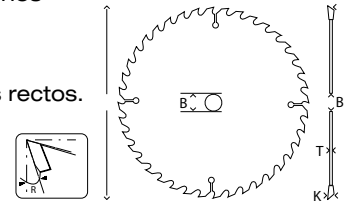

Ø 165mm DSP600 - DSP601 - SP001G - SP6000

Ø ext. (mm)	Ø int. (mm)	K (mm)	T (mm)	Nº dientes	R	Tipo de diente	Reducción	Código	EAN	P.V.P (€)
160	20	2,2	1,6	28	23°	ATB Laser slit	-	B-32982	0088381421850	31,00
165	20	2	1,4	28	15°	ATB Laser slit	-	B-56699	0088381534765	47,00
160	20	2,2	1,6	48	8°	ATB Laser slit	-	B-32998	0088381421867	37,00
165	20	2,2	1,6	48	8°	ATB Laser slit	-	B-33015	-	57,00

Especial MDF

165	20	2	1,4	60	5°	-	-	B-56786	0088381495967	61,00
-----	----	---	-----	----	----	---	---	---------	---------------	-------

Especial para Corian

165	20	2,4	1,7	48	5°	TCG	-	B-10344	0088381342100	64,00
165	20	2,0	1,4	48	5°	TCG	-	B-56742	0088381534819	71,00

Especial para Aluminio

165	20	2,4	1,7	56	-3°	TCG LaserSlit	-	B-33021		61,00
165	20	2,0	1,4	56	-3°	TCG LaserSlit	-	B-56714	0088381534802	73,00



Discos de sierra para ingletadoras

Discos MakBlade corte silencioso



Los discos de sierra MAKBLADE PLUS tienen una tecnología única y patentada. Estos discos están desarrollados para atenuar las vibraciones y el ruido. La vida de los dientes se alarga significativamente cuidando su carburo de tungsteno mejor que

los discos convencionales.

- Menor vibración y menor ruido.

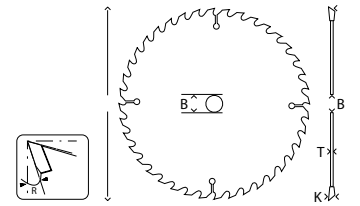

Ø 190mm DLS600 - DLS714 - LS0714F										
Ø ext. (mm)	Ø int. (mm)	K (mm)	T (mm)	Nº dientes	R	Tipo de diente	Reducción	Código	EAN	P.V.P (€)
190	20	2.0	1,4	60	5°	ATAF	-	B-08757	0088381336741	48,00
Ø 250mm DLS111 - LF1000 - LH1040F - LS004G - LS1018L - LS1019L - LS1040F										
250	30	2,6	1,8	80	5°	TCG	-	B-42640	0088381440882	98,00
250	30	2,6	1,8	80	5°	HI - ATB	-	B-42662	0088381440905	98,00
250	30	3,2	2,2	80	5°	TCG	-	B-42830	0088381433969	98,00
250	30	3,2	2,2	80	5°	HI - ATB	-	B-42852	0088381433983	98,00
Ø 260mm DLS111 - LF1000 - LH1040F - LS004G - LS1018L - LS1019L - LS1040F										
260	30	2,3	1,8	70	5°	ATAF	-	B-32530	0088381421348	66,00
Ø 305mm DLS211 - LH1201FL - LS003G - LS1219L										
305	30	2,5	1,9	70	0°	ATAF	-	B-32568	0088381421379	78,00

Discos MakBlade



Para un gran número de aplicaciones desde corte grueso a corte con un acabado extra fino.

- Las sierras de acero tensionado absorben los impactos sin deformarse.
- Carburo de tungsteno de alta calidad y bajo desgaste para una larga vida de la sierra.
- Corte fino con menos viruta y menos esfuerzo en el motor.



Ø 190mm DLS600 - LS0714F - DLS714										
Ø ext. (mm)	Ø int. (mm)	K (mm)	T (mm)	Nº dientes	R	Tipo de diente	Reducción	Código	EAN	P.V.P (€)
190	20	2,2	1,6	24	5°	ATB	-	B-32708	0088381421515	25,00
190	20	2,2	1,6	48	5°	ATB	-	B-08953	0088381336994	35,00
190	20	2.0	1,4	60	5°	ATB	-	B-09042	0088381337083	35,00
Ø 216mm LS002G - LS0815FL										
216	30	2,1	1,6	40	10°	ATB	-	A-86169	0088381150026	48,00
216	30	2,4	1,6	48	5°	ATB	-	B-32764	0088381421577	44,00
216	30	2,2	1,6	80	5°	ATB	-	A-86468	0088381150804	74,00
Ø 260mm DLS111 - LF1000 - LH1040F - LS004G - LS1018L - LS1019L - LS1040F										
255	30	2,3	1,8	32	5°	ATB	-	B-32720	0088381421539	56,00
255	30	2,3	1,8	60	5°	ATB	-	B-32792	0088381421607	41,00
260	30	2,3	1,8	40	5°	ATB	-	B-32770	0088381421584	40,00
260	30	2,3	1,8	60	5°	ATB	-	B-32801	0088381421614	48,00
260	30	2,3	1,8	80	5°	ATB	-	B-32845	0088381421652	51,00
260	30	2,3	1,8	100	5°	ATB	-	B-32873	0088381421683	54,00
260	30	2,5	1,65	80	10°	Efficut	-	B-67240	0088381541015	70,00
Ø 305mm LH1201FL - LS1219L - DLS211										
305	30	2,3	1,8	40	5°	ATB	-	B-32786	0088381421591	51,00
305	30	2,3	1,8	60	5°	ATB	-	B-32817	0088381421621	67,00
305	30	2,3	1,8	80	5°	ATB	-	B-32851	0088381421669	80,00
305	30	2,3	1,8	100	5°	ATB	-	B-32889	0088381421690	88,00
305	30	2,15	1,65	60	10°	Efficut	-	B-67309	-	83,00

Discos de sierra para ingletadoras

Discos Specialized Aluminio



- Chapa de precisión tensionada para mayor rigidez y cortes más rectos.
- Excelente calidad de corte en materiales no ferrosos.
- Perfecta realización del corte en suelos laminados.

Aplicar cera de discos en la zona del diente frecuentemente para prevenir la acumulación de viruta en los dientes cuando cortemos metales no ferrosos.

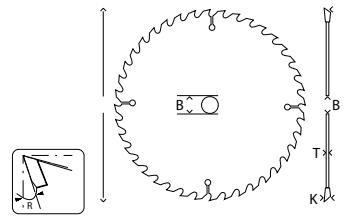

Ø 190mm DLS600 - DLS714Z - LS0714F

Ø ext. (mm)	Ø int. (mm)	K (mm)	T (mm)	Nº dientes	R	Tipo de diente	Reducción	Código	EAN	P.V.P (€)
190	20	2	1,4	60	-5°	TCG	-	B-33283	0088381422154	44,00

Ø 216mm LS0815FL - LS002G

216	30	2,2	1,6	64	-5°	TCG	-	B-33299	0088381422178	51,00
-----	----	-----	-----	----	-----	-----	---	---------	---------------	-------

Ø 260mm DLS111 - LF1000 - LH1040F - LS004G - LS1018L - LS1019L - LS1040F

250	30	2,4	1,8	72	5	ATB	-	B-33308	0088381422185	45,00
250	30	2,4	1,8	100	-5°	TCG	-	B-33314	-	73,00
260	30	2,4	1,8	80	-5°	TCG	-	B-33320	0088381422208	67,00
260	30	2,4	1,8	100	-5°	TCG	-	B-33336	0088381422215	75,00
260	30	1,85	1,5	81	-3°	SMTCG	-	E-06317	-	87,00

Ø 305mm DLS211 - LH1201FL - LS003G - LS1219L

305	30	2,4	1,8	80	-5°	TCG	-	B-33342	0088381422222	71,00
305	30	2,4	1,8	100	-5°	TCG	-	B-33358	-	98,00
305	30	2	1,65	81	-3	Efficut	-	E-13253	0088381591270	123,00
305	30	2	1,65	96	-3	Efficut	-	E-13312	0088381591287	138,00



★★★★
★★★★

Discos Specialized Standard Economy



Ø ext. (mm)	Ø int. (mm)	K (mm)	T (mm)	Nº dientes	R	Tipo de diente	Reducción	Código	EAN	P.V.P (€)
N 255	30	2,6	1,8	40	15°	ATB	-	D-74049	0088381587082	18,70
305	30	2,8	2	60	15°	ATB	-	D-72316	0088381569040	35,00
305	30	2,8	2	80	15°	ATB	-	D-72322	0088381569057	40,00
305	30	2,8	2	100	15°	ATB	-	D-72338	0088381569064	45,00



Discos Specialized Sierras de mesa - Madera



- Diseñados para sierras de mesa Makita y otros fabricantes de sierras.

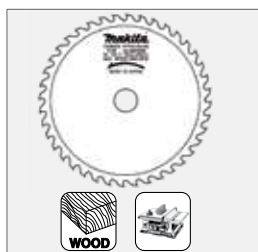
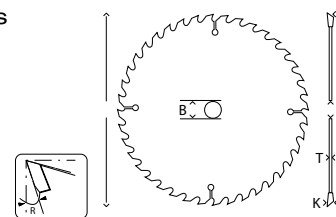

Ø 260mm 2704 y MLT100

260	30	2,3	1,5	40	20°	TCG	-	B-05072	0088381200677	46,00
N 260	30	2,6	1,8	40	15°	ATB	-	D-74077	0088381587112	19,30

Ø 315mm 2712

315	30	2,8	2,0	40	16°	Corte rápido	-	JM27170001	0088381531641	33,00
-----	----	-----	-----	----	-----	--------------	---	------------	---------------	-------

Discos Specialized Sierras de mesa - Aluminio

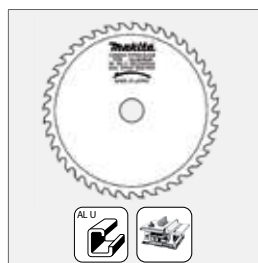

Ø 260mm 2704 - MLT100

Ø ext. (mm)	Ø int. (mm)	K (mm)	T (mm)	Nº dientes	R	Tipo de diente	Reducción	Código	EAN	P.V.P (€)
260	30	2,8	2,2	80	0°	TCG	-	B-33386		76,00

Ø 300mm

300	30	2,8	2,2	80	0°	TCG	-	B-33392	0088381422277	82,00
-----	----	-----	-----	----	----	-----	---	---------	---------------	-------

Discos Specialized laminados



- Excelente calidad de corte en suelos laminados.
- Gran precisión de corte en molduras y rodapiés.

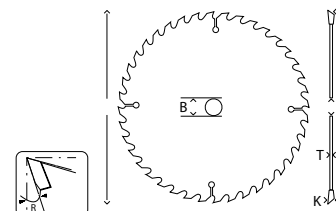

Ø 216mm LS0815FL - LS002G

Ø ext. (mm)	Ø int. (mm)	K (mm)	T (mm)	Nº dientes	R	Tipo de diente	Reducción	Código	EAN	P.V.P (€)
216	30	2,5	1,8	72	5°	TCG	-	B-33853	0088381422703	110,00

Ø 260mm DLS111 - LF1000 - LH1040F - LS004G - LS1018L - LS1019L - LS1040F

260	30	2,5	1,8	84	5°	TCG	-	B-29496	0088381416641	102,00
-----	----	-----	-----	----	----	-----	---	---------	---------------	--------

Ø 305mm DLS211 - LH1201FL - LS003G - LS1219L

305	30	2,5	1,8	96	5°	TCG	-	B-33881	0088381422734	168,00
-----	----	-----	-----	----	----	-----	---	---------	---------------	--------

Disco PCD especial fibrocemento



Ø 165mm

Ø ext. (mm)	Ø int. (mm)	K (mm)	T (mm)	Nº dientes	R	Tipo de diente	Reducción	Código	EAN	P.V.P (€)
165	20	1,8	1,4	4	12°	PCD	-	D-72067	-	36,00

Discos Specialized Fresado CA5000



Ø 118mm - CA5000



Ø ext. (mm)	Ø int. (mm)	K (mm)	T (mm)	Nº dientes	R	Material	Reducción	Código	EAN	P.V.P (€)
118	20	14	6	6	90°	Aluminio composite	-	B-48832	0088381458733	178,00
118	20	18	6	6	135°	Aluminio composite	-	B-48860	0088381458740	196,00

Cuchillas de corte DSC102 / SC103D

Disco de corte CP100D



Tipo	Código	EAN	P.V.P (€)
M6	199087-8	0088381524766	73,00
M8	199085-2	0088381524759	73,00
M10	199083-6	0088381524742	73,00



Código	EAN	P.V.P (€)
198603-3	0088381487344	10,10

Disco de corte DSC250

Ø 110mm - DSC250 - DSC251



Ø ext. (mm)	Ø int. (mm)	K (mm)	T (mm)	Nº dientes	R	Tipo de diente	Reducción	Código	EAN	P.V.P (€)
110	15	-	-	24	0°	SMTCG	-	E-11097	0088381581752	72,00



Makita

Discos de sierra para cortadoras de metal

Discos Specialized - Corte de metal

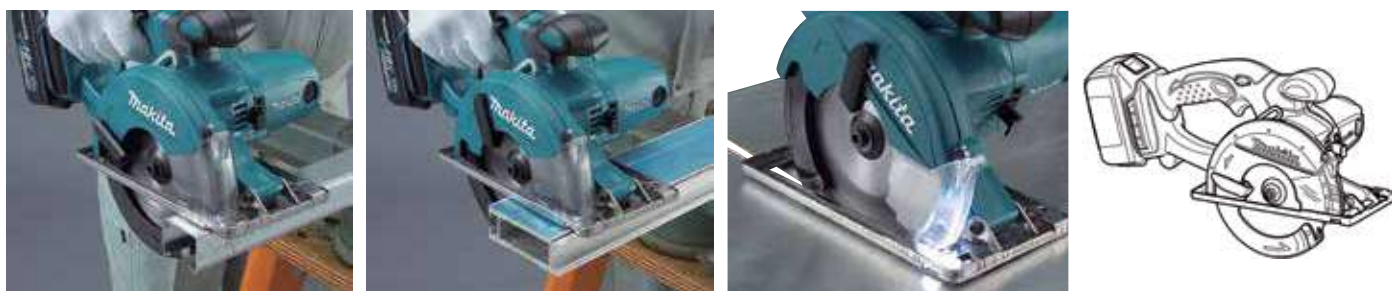

Ø 136mm DCS550

Ø ext. (mm)	Ø int. (mm)	K (mm)	T (mm)	Nº dientes	Tipo	Tipo de diente	Reducción	Código	EAN	P.V.P (€)
136	20	1,5	1,2	30	-	SMTCG	Metal	B-33526	-	44,00
136	20	1,4	1,0	50	-	SMTCG	Chapa fina	B-07325	0088381312813	47,00
136	20	1,1	0,95	56	-	SMTCG	Inox	B-33744	-	73,00

Ø 150mm DCS551 - DCS553

150	20	1,5	1,2	32	-	SMTCG	Metal	B-47036	-	44,00
150	20	1,4	1,1	52	-	SMTCG	Chapa fina	B-47042	-	61,00
150	20	1,1	0,95	60	-	SMTCG	Inox	B-47058	-	66,00
150	20	1,6	1	52	-	SMTCG	Aluminio	B-47064	-	61,00

Ø 185mm 4131

Ø ext. (mm)	Ø int. (mm)	K (mm)	T (mm)	Nº dientes	Tipo	Tipo de diente	Reducción	Código	EAN	P.V.P (€)
185	30	1,7	1,3	70	-	HM	Acero	B-33445	-	57,00
185	30	2	1,6	48	-	HM	Acero	B-33451	-	56,00
185	30	2	1,6	38	-	HM	Acero	B-33423	-	50,00
185	30	-	-	38	-	HM	Acero	E-14299	0088381593656	72,00
185	30	1,9	1,5	36	-	Cermet	Acero	B-33417	0088381422291	70,00

Ø 305mm LC1230

305	25,4	2,1	1,7	60	-	HM	Acero	B-33439	-	123,00
305	25,4	2,3	2	78	-	HM	Acero Suave	B-33467	-	149,00
305	25,4	1,95	1,95	76	-	HM	Inox	A-87579	0088381160445	254,00
305	25,4	2,4	1,5	100	Silencioso	HM	Inox	B-33750	-	303,00
N 305	25,4	2	1,75	63	-2°	Efficut	Acero	E-12055	-	303,00



Discos de HM para LC1230











Ø (mm)	Nº de dientes	Código
305	HM60	B-33439
	HM78	B-33467
	HM76	A-87579
	HM100	B-33750

Discos de HM para 4131



Ø (mm)	Nº de dientes	Código
185	HM70	B-33445
	HM48	B-33451
	HM38	B-33423
	Cermet 36	B-33417

Código	B-33439	B-33467	A-87579	B-33750
Ø (mm.)	305 x 25,4			
Nº dientes	HM60	HM78	HM76	HM100
Material	Acero	Acero suave fino	Inox	Inox
 3 mm.	△	⊙	○	○
 4 - 6 mm.	⊙	○	○	○
 7 mm. -	○	×	○	○
 1,2 - 3 mm.	△	⊙	○	○
 3 - 5 mm.	⊙	○	○	○
 2 - 4 mm.	△	⊙	○	○
 4 mm. -	⊙	○	○	○
 Inox 1,2 - 3 mm.	×	×	⊙	⊙

Código	B-09771	B-33451	B-33423	B-33417
Ø (mm.)	185x30x2	185x30x2	185x30x2	185x30x1,9
Nº dientes	HM70 (-10°)	HM48 (0°)	HM38 (0°)	*Cermet36 (0°)
Cuadrado de hierro	50 x 50 x 4 mm.	×	△	○
	50 x 50 x 4 mm.	×	○	△
	50 x 50 x 6 mm.	×	○	⊙
	50 x 100 x 3,2 mm.	×	○	⊙
Acero en planchas	0,9 x 500 mm.	⊙	○	△
	3,0 x 500 mm.	△	○	⊙
Perfiles en U	50 x 100 x 1,6 mm.	×	○	△
	45 x 90 x 3,2 mm.	×	○	⊙
Angulo	50 x 50 x 4 mm.	×	△	○
	50 x 50 x 6 mm.	×	○	⊙
Tubos de acero templado	Ø 25 x 1,2 mm.	×	⊙	○
Tubos metálicos	Ø 60 x 4 mm.	×	△	○
Varilla	Ø 20 mm.	×	△	○
Perfiles de tabiquería seca	1 mm.	⊙	×	×
	1 - 2 mm.	×	⊙	△
Chapa ondulada (pegaso)	0,9 mm.	⊙	×	×
	1 - 2 mm.	△	△	×



- ⊙ Disco ideal.
- Disco válido.
- △ Disco no recomendado.
- × Disco muy desaconsejado.

Guías de carril y accesorios



Pieza para unir dos carriles

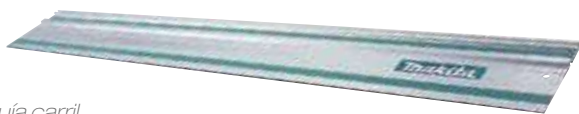

Guía carril



Funda para carril guía

Descripción	Longitud (m)	Unds.	Código	EAN	P.V.P (€)
Pieza para unir dos carriles	-	1	198885-7	0088381497046	27,00
Guía carril	1	1	199140-0	0088381528672	48,00
	1,4	1	194368-5	0088381313353	76,00
	1,9	1	194925-9	0088381354790	117,00
	3	1	194367-7	0088381335201	198,00
Funda para carril guía	1	1	E-05670	0088381567183	49,00
	1,4	1	E-05664	0088381567176	57,00
	1,9	1	E-10920	0088381581523	89,00
	3	1	E-10936	0088381581530	110,00

Guía de ángulos



Unds.	Código	EAN	P.V.P (€)
1	196664-7	0088381438414	42,00

Soportes de guía de carril

A



192505-5

B



192506-3 y 192507-1

C

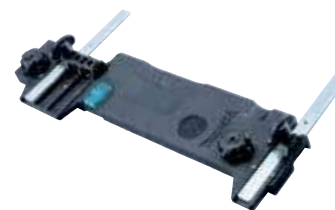

197252-3

D



199232-5

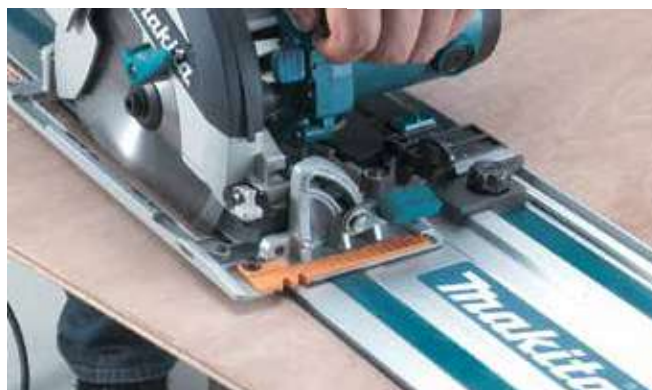

Modelos	Imagen	Unds.	Código	EAN	P.V.P (€)
5603R 5705R	A	1	192505-5	0088381131919	31,00
5903R	B	1	192506-3	0088381132190	122,00
5103R	B	1	192507-1	0088381132206	91,00
HS6100 HS7100 HS7101 DHS710	C	1	197252-3	0088381453790	71,00
HS0600	C	1	198570-2	0088381495912	230,00
HS6601	C	1	197462-2	0088381523837	29,00
HS7601 HS7611	C	1	197005-0	0088381484602	70,00
DHS680	C	1	196953-0	0088381463751	56,00
DHS660	D	1	199232-5	0088381529334	56,00

Repuestos para guías de carril

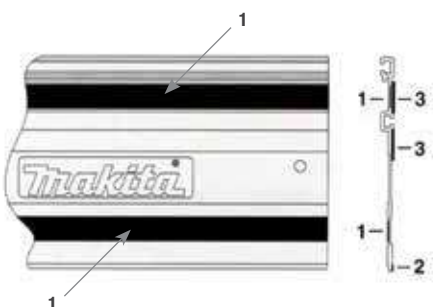

Descripción	Longitud	Número	Unds.	Código	EAN	P.V.P (€)
Goma deslizante	1,4	1	1	413101-9	3240890284549	4,40
	1,9		1	451330-6	-	6,60
	3,0		1	413102-7	3240890284488	16,50
Goma antiastillas	1,4	2	1	423359-2	3240890283870	6,00
	1,9		1	423386-9	-	8,80
	3,0		1	423360-7	3240890284136	11,80
Goma antideslizante	1,4	3	1	423361-5	3240890282088	7,20
	1,9		1	423390-8	-	9,90
	3,0		1	423362-3	3240890281838	16,50

Mordaza para carril guía



Modelos	Unds.	Código	EAN	P.V.P (€)
Guías de carril	2	194385-5	0088381314084	30,00

Guía paralela



Tipo 1

Tipo 2

Modelos	Tipo	Unds.	Código	EAN	P.V.P (€)
HS301	1	1	195333-7	-	3,30
5604R 5704R HS6100 HS7100 HS7101 HS7601		1	164095-8	0088381101080	1,95
5017RKB 5603R 5703R 5705R		1	165108-8	0088381141376	6,90
5903R 5103R		1	165084-6	0088381152464	4,50
5143R		1	152498-8	0088381156295	50,00
DSP600 DSP601 SP6000	2	1	165447-6	0088381347587	17,00

Placa guía para CA5000

- Marca la línea de fresado.



Modelos	Unds.	Código	EAN	P.V.P (€)
CA5000	1	143396-7	-	4,40

Ganchos



Modelos	Unds.	Código	EAN	P.V.P (€)
DHS780	1	199386-8	0088381534963	16,70
DHS660	1	199231-7	0088381532839	9,50

Mesa para ingletadoras



194043-3



DEAWST05



DEAWST06
DEAWST07

	Largo (mm)	Alto (mm)	Ancho (mm)	Modelos	Unds.	Código	EAN	P.V.P (€)
	762	841	743	LS0714F LH1040F LS1019L LS1018L LS1040F LS1219L LH1201FL	1	198688-9	0088381488938	200,00
	2.700	500	800	Todos los modelos	1	DEAWST05	0088381424318	349,00
	2.550	750	850		1	DEBWST06	0088381567350	318,00
	3.830	860	750	Válida para todos los modelos a excepción de DLS600, LH1040/F y LH1201FL.	1	DEAWST07	0088381565301	435,00



Mesas para sierras de mesa



194093-8

JM27000300

Modelos	Unds.	Código	EAN	P.V.P (€)
2704	1	194093-8	0088381205702	375,00
MLT100	1	JM27000300	0088381351003	275,00



Extensión de soporte



Modelos	Tipo	Unds.	Código	EAN	P.V.P (€)
LH1040 LS1040 LS0714F MLS100	Pie	1	122446-1	0088381156158	29,00
-	Barras	1	256812-1	0088381146517	26,00

Rodillo auxiliar



Largo (mm)	Altura regulable (mm)	Unds.	Código	EAN	P.V.P (€)
250	47 - 140	1	A-47450	0088381289535	109,00

Tope de apoyo



Modelos	Unds.	Código	EAN	P.V.P (€)
LS1013F/FLB LS1214F/L	1	194002-7	0088381193795	60,00

Topes para cortes de molduras



Modelos	Unds.	Código	EAN	P.V.P (€)
LS003G LS004G LS1019L LS1219L	2	192628-9	0088381141710	43,00
LS1016/L	2	192669-5	0088381146470	76,00

Soportes laterales

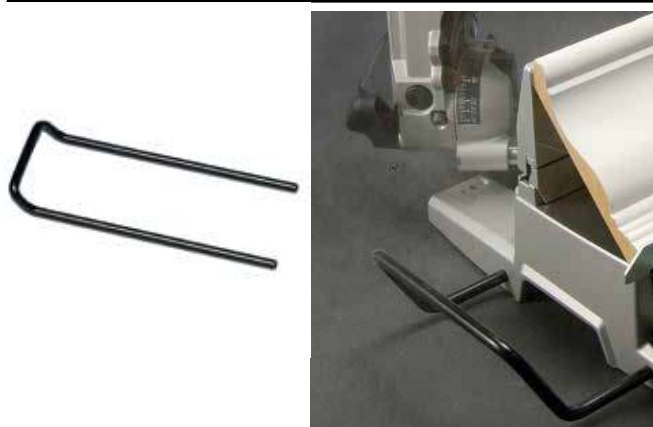

Modelos	Unds.	Código	EAN	P.V.P (€)
LS0810	1	164806-1	0088381162517	8,20
LS1013F/FLB LS1214F/L	1	322932-4	0088381141673	7,00
LH1040F LS1040F	1	123101-8	0088381538244	16,00
LS1440	2 + Tope ajustable	191239-7	0088381112093	30,00
MLS100	1	JM23000127	0088381347907	9,90
LS1016/L LS1216/FLB	2	195240-4	0088381366250	9,60
LH1200FL	1	JM23100500	0088381373623	11,40
LS1019L LS1219L	1	327095-1	0088381536189	5,90



Mordazas para ingletadoras

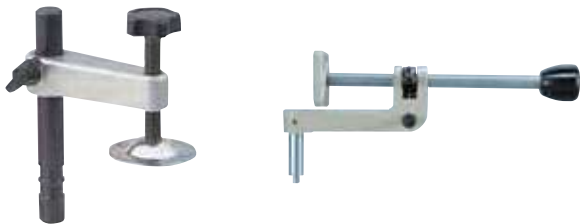

Vertical

Horizontal

Modelos	Tipo	Unds.	Código	EAN	P.V.P (€)
LS0714F BLS713RFE	Vertical	1	122571-8	0088381151863	23,00
LS0815		1	JM23510009	0088381447331	11,00
LS1013 LS1214		1	122538-6	0088381141697	20,00
LH1040F LS1040F		1	192625-5	0088381150729	20,00
LS1016/L LS1216/FL		1	122854-6	0088381356619	27,00
LF1000		1	122728-1	0088381288484	17,70
LS1018 LH1200FL		1	JM23100502	0088381373661	6,50
LS1019L LS1219L		1	126617-2	-	30,00
MLS100		1	JM23000131	0088381347938	8,20
LS0714F LS1040 LH1040		Horizontal	1	122567-9	0088381151573
LS1013 LS1214 LS1016/L LS1019L LS1219L	1		122470-4	0088381142625	91,00
LS1216/FLB LH1200FL LS1018L	1		122930-6	0088381366274	79,00

Guías paralelas



Modelos	Unds.	Código	EAN	P.V.P (€)
2704	1	122739-6	0088381277020	124,00
LH1040F	1	122707-9	0088381195386	17,20
LF1000	1	122729-9	0088381288460	29,00
LH1201FL	1	JM23300008	3240890401823	56,00
2712	1	JM27110005	3240890419248	40,00

Botón de seguridad



Modelos	Unds.	Código	EAN	P.V.P (€)
Todos los modelos	1	417113-4	-	0,65

Arnés para DLS600



Modelos	Unds.	Código	EAN	P.V.P (€)
DLS600	1	166058-0	0088381494953	11,60

Guías de ingletes



Modelos	Unds.	Código	EAN	P.V.P (€)
2704N	1	127069-0	-	49,00
LF1000	1	122730-4	0088381288477	16,50

Extensiones para 2704

Extensión trasera

Extensión izquierda



Descripción	Unds.	Código	EAN	P.V.P (€)
Extensión trasera	1	194087-3	0088381200301	44,00
Extensión izquierda	1	194086-5	0088381200295	36,00

Topes ajustables



Modelos	Unds.	Código	EAN	P.V.P (€)
LH1040 LS0714 LS1040	1	122472-0	0088381155892	5,50
MLS100	1	JM23000128	0088381347914	0,80



Bolsa y cajón recoge polvo



122852-0



194175-6

Arandela de reducción

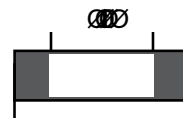

Ø Interior (mm)	Ø Exterior (mm)	Unds.	Código	EAN	P.V.P (€)
15,88	25	1	257022-3	0088381189293	0,85
15,88	25,4	1	257060-5	0088381189309	1,40
15,88	30	1	257262-3	-	0,85

Palo de empuje



Unds.	Código	EAN	P.V.P (€)
1	416772-1	0088381149426	4,30

Lámpara



Modelos	Unds.	Código	EAN	P.V.P (€)
LS0714F LS1013F LS1214F LS1040F	1	193730-1	0088381160353	4,10



Descripción	Modelo	Unds.	Código	EAN	P.V.P (€)
Bolsa	LS1018 LH1201FL	1	JM23100501	0088381373654	3,70
Bolsa	LS0810	1	122351-2	0088381115537	8,50
Bolsa	LS0815		JM23510010	0088381447348	7,20
Bolsa	LS1440	1	122330-0	0088381115544	16,00
Bolsa	LH1040 LS1214 LS1040 LS1016/L LS11019L LS1219L LS1216/FLB	1	122852-0	0088381356602	3,80
Bolsa	DLS600	1	122884-7	-	6,40
Cajón	Modelos FLB	1	194175-6	0088381349994	40,00



Sierras de sable



Sierras de sable

XGT **40V** Li-Ion **max**



Mecanismo orbital

Mayor velocidad de corte

Sistema de corte orbital

Para cortes en madera y en cemento ligero

Sistema de corte recto

Para cortar tubos de hierro, tubos de aluminio, de acero inoxidable o de distintos plásticos.

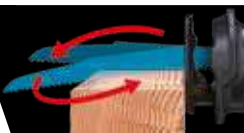

Luz LED dual de trabajo

Con funciones de luminiscencia y preluminiscencia



Gancho

Dial de velocidad variable



Sistema de anticaída para la sierra

Previene la caída cuando se ajusta la posición de la sierra. Además, facilita el cambio de la misma sin herramientas accionando la palanca y pulsando el botón.



Mecanismo de lubricación del eje rediseñado

BL MOTOR
Motor de alta potencia sin escobillas

Eje

Contrapeso



AVT
TECNOLOGÍA ANTIVIBRACION

Tecnología antivibración. Se consigue reducir la vibración de la herramienta al mínimo gracias a un mecanismo de contrapeso

Símbolos



Tipo de dentado

Tipo A

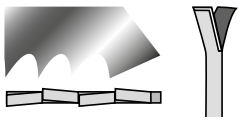

- Dentado: afilado triscado, cortes rápidos en maderas duras y blandas, aluminio, plásticos y metales no ferrosos.

Tipo B

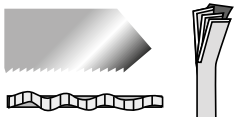

- Dentado: afilado ondulado, corte fino y limpio en madera, acero blando, aluminio y metales no ferrosos.

Tipo C

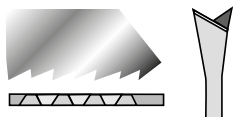

- Dentado: afilado trapezoidal, cortes finos y limpios en madera y plásticos.

Tipo C

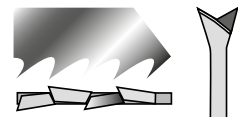

- Dentado: afilado triscado trapezoidal, cortes gruesos y rápidos en madera.

Sierras de sable

Metal



Características	Tipo	Tipo de dientes	Dientes / pulgada	Largo (mm)	Ancho (mm)	Unds.	Código	EAN	P.V.P. (€)
Para corte de acero, inoxidable y metales no ferrosos entre 3,5mm y 5mm. (El color de la hoja puede variar - azul o blanca).	BiM	B	10 / 14	305	0,9	5	B-16857	0088381367554	22,00
				225			P-47008	0088381977432	21,00
				152			P-46997	0088381977425	16,10



Características	Tipo	Tipo de dientes	Dientes / pulgada	Largo (mm)	Ancho (mm)	Unds.	Código	EAN	P.V.P. (€)
Para corte de metal de 4mm a 12mm. Corte rápido.	BiM	B	8 / 10	305	0,9	5	B-43212	0088381443081	26,00
				225			B-43181	0088381443050	22,00
				152			B-43147	0088381443012	18,50

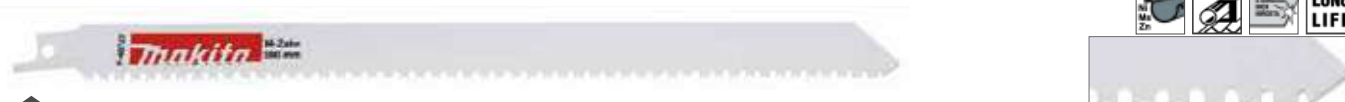

Características	Tipo	Tipo de dientes	Dientes / pulgada	Largo (mm)	Ancho (mm)	Unds.	Código	EAN	P.V.P. (€)
Diente en M para el corte rápido de acero, inoxidable y metales no ferrosos. Corta en las dos direcciones para aumentar la velocidad de corte.	BiM	M	M	260	0,9	5	P-45727	0088381976169	27,00
				200			P-45711	0088381976152	22,00
				150			P-45705	0088381976145	18,30



Características	Tipo	Tipo de dientes	Dientes / pulgada	Largo (mm)	Ancho (mm)	Unds.	Código	EAN	P.V.P. (€)
Chapa gruesa. 4-12mm, tubo <100mm.	TC	-	8	152	1,25	1	B-55572	0088381483575	18,70
Chapa gruesa. 4-12 mm, tubo <175 mm.	TC	-	8	228	1,25	1	B-55588	0088381483582	22,00
Chapa gruesa. 4-12 mm, tubo <250 mm.	TC	-	8	305	1,25	1	B-55594	0088381483599	29,00

Metal



Características	Tipo	Tipo de dientes	Dientes / pulgada	Largo (mm)	Ancho (mm)	Unds.	Código	EAN	P.V.P. (€)
Para corte de chapa menor a 1,2mm.	BiM	B	32	150	0,9	5	P-04955	0088381914109	16,60

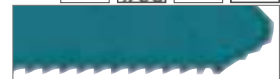

Características	Tipo	Tipo de dientes	Dientes / pulgada	Largo (mm)	Ancho (mm)	Unds.	Código	EAN	P.V.P. (€)
Para corte de chapa mayor a 1,2mm. (El color de la hoja puede variar - azul o blanca).	BiM	B	24	225	0,9	5	B-43169	0088381443036	18,70
				152			B-16835	0088381367530	12,70
				100			P-04896	0088381914048	14,90



Características	Tipo	Tipo de dientes	Dientes / pulgada	Largo (mm)	Ancho (mm)	Unds.	Código	EAN	P.V.P. (€)
Para corte de acero e inoxidable entre 1,5mm y 2,5mm (El color de la hoja puede variar - azul o blanca).	BiM	B	12	225	0,9	5	B-16776	0088381367479	17,70
				152			B-05169	0088381204224	13,80
				100			P-04874	0088381914024	14,90



Características	Tipo	Tipo de dientes	Dientes / pulgada	Largo (mm)	Ancho (mm)	Unds.	Código	EAN	P.V.P. (€)
Para corte de metal de 3mm a 8mm.	BiM	B	14 / 18	305	1,1	5	B-43206	0088381443074	26,00
				225			B-43175	0088381443043	22,00
				152			B-43131	0088381443005	17,70



Características	Tipo	Tipo de dientes	Dientes / pulgada	Largo (mm)	Ancho (mm)	Unds.	Código	EAN	P.V.P. (€)
Para corte de acero e inoxidable entre 1,5mm y 2,5mm.	BiM	B	18	225	0,9	5	B-16782	0088381367486	17,70
				152			B-16841	0088381367547	12,70



Características	Tipo	Tipo de dientes	Dientes / pulgada	Largo (mm)	Ancho (mm)	Unds.	Código	EAN	P.V.P. (€)
Para corte de metal de 2mm a 10mm. Corte fino.	BiM	B	10 / 14	305	1,25	5	B-43228	0088381443098	26,00
				225			B-43197	0088381443067	22,00
				152			B-43153	0088381443029	17,70



Madera



Características	Tipo	Tipo de dientes	Dientes / pulgada	Largo (mm)	Ancho (mm)	Unds.	Código	EAN	P.V.P. (€)
Para toda clase de maderas con un acabado fino.	HCS / CV	A	10	152	1,05	5	B-16807	0088381367509	9,60

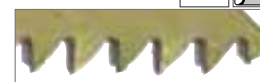
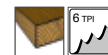

Características	Tipo	Tipo de dientes	Dientes / pulgada	Largo (mm)	Ancho (mm)	Unds.	Código	EAN	P.V.P. (€)
Hoja gruesa para cortes rápidos en madera, plásticos y placas de yeso.	HCS / CV	A	6	305	1,25	5	B-16829	0088381367523	16,00



Características	Tipo	Tipo de dientes	Dientes / pulgada	Largo (mm)	Ancho (mm)	Unds.	Código	EAN	P.V.P. (€)
Hoja gruesa para cortes rápidos en madera, plásticos y placas de yeso.	HCS / CV	A	6	225	1,27	5	P-47092	0088381977524	14,90



Características	Tipo	Tipo de dientes	Dientes / pulgada	Largo (mm)	Ancho (mm)	Unds.	Código	EAN	P.V.P. (€)
Hoja gruesa para cortes rápidos en madera, plásticos y placas de yeso.	HCS / CV	C	6	150	1,27	5	P-47086	0088381977517	13,70



Características	Tipo	Tipo de dientes	Dientes / pulgada	Largo (mm)	Ancho (mm)	Unds.	Código	EAN	P.V.P. (€)
Hoja gruesa para cortes rápidos en madera, plásticos y placas de yeso.	BIM	A	6	150	1,27	5	P-05088	0088381914314	22,00



Características	Tipo	Tipo de dientes	Dientes / pulgada	Largo (mm)	Ancho (mm)	Unds.	Código	EAN	P.V.P. (€)
Hoja especial para madera verde	HCS/CV	C	5	305	1,5	5	B-16863	0088381367561	20,00

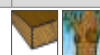

Características	Tipo	Tipo de dientes	Dientes / pulgada	Largo (mm)	Ancho (mm)	Unds.	Código	EAN	P.V.P. (€)
Hoja especial para madera verde	HCS/CV	C	4 - 5	240	1,27	5	P-47117	0088381977548	16,60



Características	Tipo	Tipo de dientes	Dientes / pulgada	Largo (mm)	Ancho (mm)	Unds.	Código	EAN	P.V.P. (€)
Para corte curvo en madera y plástico.	HCS/CV	C	6	152	1,27	5	B-16798	0088381367493	9,60



Madera



Características	Tipo	Tipo de dientes	Dientes / pulgada	Largo (mm)	Ancho (mm)	Unds.	Código	EAN	P.V.P. (€)
Para corte curvo y limpio en madera, plástico y plexiglás.	HCS / CV	D	6	150	1,8	5	P-47101	0088381977531	21,00



Características	Tipo	Tipo de dientes	Dientes / pulgada	Largo (mm)	Ancho (mm)	Unds.	Código	EAN	P.V.P. (€)
Hoja gruesa para cortes rápidos en madera, plásticos y placas de yeso.	HCS / CV	A	3	152	1,25	5	B-16813	0088381367516	9,60



Características	Tipo	Tipo de dientes	Dientes / pulgada	Largo (mm)	Ancho (mm)	Unds.	Código	EAN	P.V.P. (€)
Dentado muy grueso para cortes rápidos y agresivos en maderas húmedas.	HCS / CV	C	3	240	1,27	5	P-47123	0088381977555	17,80



Características	Tipo	Tipo de dientes	Dientes / pulgada	Largo (mm)	Ancho (mm)	Unds.	Código	EAN	P.V.P. (€)
Dentado muy grueso para cortes rápidos y agresivos en maderas húmedas.	HCS / CV	D	8,5	250	1,0	1	B-62016	0088381528719	16,50

S-EXPRESS



Características	Tipo	Tipo de dientes	Dientes / pulgada	Largo (mm)	Ancho (mm)	Unds.	Código	EAN	P.V.P. (€)
Hoja superexpress con un gran rendimiento en las sierras de sable a batería: Metal.	BiM	-	7 - 18	152	-	5	B-05038	0088381200592	17,70

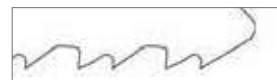

Características	Tipo	Tipo de dientes	Dientes / pulgada	Largo (mm)	Ancho (mm)	Unds.	Código	EAN	P.V.P. (€)
Hoja superexpress con un gran rendimiento en las sierras de sable a batería: Universal.	BiM	-	6 - 11	152	-	5	B-05044	0088381200608	15,40



Características	Tipo	Tipo de dientes	Dientes / pulgada	Largo (mm)	Ancho (mm)	Unds.	Código	EAN	P.V.P. (€)
Hoja superexpress con un gran rendimiento en las sierras de sable a batería: Madera.	BiM	-	6 - 10	203	-	5	B-05153	0088381200943	16,00



Madera + Metal



Características	Tipo	Tipo de dientes	Dientes / pulgada	Largo (mm)	Ancho (mm)	Unds.	Código	EAN	P.V.P. (€)
Especial Palet	BIM	B	10	180	0,9	200	B-54265	0088381477307	412,00



Características	Tipo	Tipo de dientes	Dientes / pulgada	Largo (mm)	Ancho (mm)	Unds.	Código	EAN	P.V.P. (€)
Especial para la reparación de palets. Para corte de madera con residuos metálicos. Hoja gruesa.	BIM	A	8/10	150	1,27	5	P-47064	0088381977494	20,00



Características	Tipo	Tipo de dientes	Dientes / pulgada	Largo (mm)	Ancho (mm)	Unds.	Código	EAN	P.V.P. (€)
Madera con clavo, pvc, demolición.	BiM	-	5/8	305	1,6	5	B-43278	0088381443142	32,00
	BiM	-	5/8	225	1,6	5	B-43256	0088381443128	28,00
	BiM	-	5/8	152	1,6	5	B-43234	0088381443104	22,00



Características	Tipo	Tipo de dientes	Dientes / pulgada	Largo (mm)	Ancho (mm)	Unds.	Código	EAN	P.V.P. (€)
Diente en M para el corte rápido de madera y madera con clavo. Corta en las dos direcciones para aumentar la velocidad de corte.	BiM	A	6	152	1,25	5	B-05175	0088381204231	16,00



Características	Tipo	Tipo de dientes	Dientes / pulgada	Largo (mm)	Ancho (mm)	Unds.	Código	EAN	P.V.P. (€)
Diente en M para el corte rápido de madera y madera con clavo. Corta en las dos direcciones para aumentar la velocidad de corte.	BiM	M	-	200	0,9	5	P-45696	0088381976138	22,00
	BiM	M	-	150	0,9	5	P-45680	0088381976121	18,30



Madera + Metal



Características	Tipo	Tipo de dientes	Dientes / pulgada	Largo (mm)	Ancho (mm)	Unds.	Código	EAN	P.V.P. (€)
Especial para la reparación de palets. Para corte de madera con residuos metálicos. Hoja gruesa.	BiM	A	10 / 14	225	1,27	5	P-47195	0088381977623	21,00
	BiM	A	10 / 14	150	1,27	5	P-47189	0088381977616	16,10



Características	Tipo	Tipo de dientes	Dientes / pulgada	Largo (mm)	Ancho (mm)	Unds.	Código	EAN	P.V.P. (€)
Especial para la reparación de palets. Para corte de madera con residuos metálicos. Hoja fina.	BiM	A	10 / 14	280	0,9	5	P-67767	0088381998291	26,00
	BiM	A	10 / 14	152	0,9	5	P-47014	0088381977449	15,40

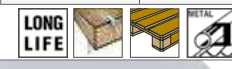

Características	Tipo	Tipo de dientes	Dientes / pulgada	Largo (mm)	Ancho (mm)	Unds.	Código	EAN	P.V.P. (€)
Especial palet. Madera con clavo, PVC y aluminio.	BiM	B	10 / 14	225	0,9	5	B-43262	0088381443135	18,70
	BiM	B	10 / 14	152	0,9	5	B-43240	0088381443111	13,80

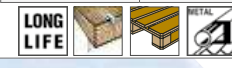

Características	Tipo	Tipo de dientes	Dientes / pulgada	Largo (mm)	Ancho (mm)	Unds.	Código	EAN	P.V.P. (€)
Especial palet, madera con clavo, aluminio.	BiM	B	10	225	0,9	5	B-31859	0088381420129	18,70
	BiM	B	10	152	0,9	5	B-31843	0088381420112	13,80



ESPECIALES

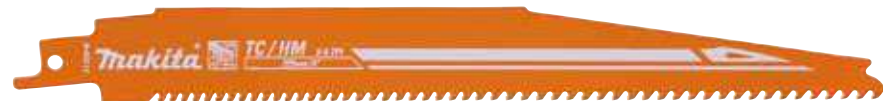

Características	Tipo	Tipo de dientes	Dientes / pulgada	Largo (mm)	Ancho (mm)	Unds.	Código	EAN	P.V.P. (€)
Sierra de sable de rescate 152x1,25 mm 6-8 TPI. Recomendada para situaciones de rescate.	TC / HM	-	6 - 8	152	1,25	25	B-67206	0088381540759	290,00
Sierra de sable de rescate 225/1,25x6-8 TPI	TC / HM	-	6 - 8	225	1,25	25	B-67212	0088381540766	495,00

ESPECIALES



Características	Tipo	Tipo de dientes	Dientes / pulgada	Largo (mm)	Ancho (mm)	Unds.	Código	EAN	P.V.P. (€)
Ideal para maderas duras, hormigón esponjoso, eternita y plásticos reforzados con fibra de vidrio y epoxy. Dientes de carburo de tungsteno	HM	A	3	400	1,3	1	P-05066	0088381914215	49,00
	HM	A	6	300	1,3	-	P-05050	0088381914208	55,00
				150			P-05044	0088381914192	26,00
				100			P-05038	0088381914185	22,00



Características	Tipo	Tipo de dientes	Dientes / pulgada	Largo (mm)	Ancho (mm)	Unds.	Código	EAN	P.V.P. (€)
Especial para ladrillo.	HM	-	2	400	-	1	B-10403	0088381342667	50,00
				265			B-10394	0088381342650	36,00

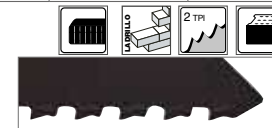

Características	Tipo	Tipo de dientes	Dientes / pulgada	Largo (mm)	Ancho (mm)	Unds.	Código	EAN	P.V.P. (€)
Especial para ladrillo hueco.	HM - TC	-	2	240	-	1	B-12809	0088381355544	28,00



Características	Tipo	Tipo de dientes	Dientes / pulgada	Largo (mm)	Ancho (mm)	Unds.	Código	EAN	P.V.P. (€)
Para cortes en cerámica, hierro de fundición, ladrillo muy duro y plásticos reforzados con fibra de vidrio y epoxy.	CV-HM	-	-	180	1,05	2	P-47173	0088381977609	17,20



Características	Tipo	Tipo de dientes	Dientes / pulgada	Largo (mm)	Ancho (mm)	Unds.	Código	EAN	P.V.P. (€)
Especial para productos congelados. Hoja de acero inoxidable sin pinturas.	INOX	-	6	152	-	1	B-52043	0088381467544	24,00
		A		305			B-10609	0088381346641	10,20
		-		228			B-30564	0088381418607	24,00



Características	Tipo	Tipo de dientes	Dientes / pulgada	Largo (mm)	Ancho (mm)	Unds.	Código	EAN	P.V.P. (€)
Especial para corte en inoxidable.	HN	-	18	152	-	2	B-07250	0088381310734	32,00



Características	Tipo	Tipo de dientes	Dientes / pulgada	Largo (mm)	Ancho (mm)	Unds.	Código	EAN	P.V.P. (€)
Fibrocemento / Ladrillo 10-250mm epoxy 6-150mm	TC / HM	-	3	305	1,5	2	B-63585	0088381532846	43,00



Características	Tipo	Tipo de dientes	Dientes / pulgada	Largo (mm)	Ancho (mm)	Unds.	Código	EAN	P.V.P. (€)
Fibrocemento / Ladrillo 20-350mm epoxy 6-150mm	TC / HM	-	2	400	1,5	2	B-63591	0088381532853	51,00



Para sierra de sable JR100D - DJR183



Características	Tipo	Tipo de dientes	Dientes / pulgada	Largo (mm)	Ancho (mm)	Unds.	Código	EAN	P.V.P. (€)
Metal	BiM	-	24	100	0,7 - 3,0	5	B-20395	0088381375986	12,10



Características	Tipo	Tipo de dientes	Dientes / pulgada	Largo (mm)	Ancho (mm)	Unds.	Código	EAN	P.V.P. (€)
Metal	BiM	-	18	100	1,5 - 4,0	5	B-20404	0088381375993	12,10



Características	Tipo	Tipo de dientes	Dientes / pulgada	Largo (mm)	Ancho (mm)	Unds.	Código	EAN	P.V.P. (€)
Metal	BiM	-	14	100	3,0 - 8,0	5	B-20410	0088381376006	12,10



Características	Tipo	Tipo de dientes	Dientes por pulgada	Largo total (mm)	Ancho (mm)	Unds.	Código	EAN	P.V.P. (€)
Madera - metal	BiM	-	10	100	Metal 3,0 - 12 / Madera 10 - 50	5	B-20426	0088381376013	12,10



Características	Tipo	Tipo de dientes	Dientes / pulgada	Largo (mm)	Ancho (mm)	Unds.	Código	EAN	P.V.P. (€)
Madera con clavo	BiM	-	6	100	10 - 50	5	B-20432	0088381376020	12,10



Características	Tipo	Tipo de dientes	Dientes / pulgada	Largo (mm)	Ancho (mm)	Unds.	Código	EAN	P.V.P. (€)
Tableros de fibra	BiM	-	6	100	5,0 - 50	5	B-20448	0088381376037	12,10



Características	Tipo	Tipo de dientes	Dientes / pulgada	Largo (mm)	Ancho (mm)	Unds.	Código	EAN	P.V.P. (€)
Madera - metal	BiM	-	14 / 18	100	Metal 3,0 - 8,0 / Madera 10 - 50	5	B-20454	0088381376044	12,10



Hojas para 2107FK / 2107FXK (13 mm. x 0,5 mm. x 1.140 mm.)

Corte METAL



Dientes por pulgada	Capacidad máxima	Espesor (mm)	Material	Unds.	Código	EAN	P.V.P. (€)
14 HCS	+ de 5 mm	0,5 mm	Acero al carbono	3	792560-3	0088381117517	40,00
18 HCS	4 - 5 mm	0,5 mm		3	792559-8	0088381117524	40,00
24 HCS	- de 4 mm	0,5 mm		3	792558-0	0088381117531	40,00
14 HSS	+ de 5 mm	0,5 mm	Bi-Metal	1	194691-8	0088381350808	22,00
18 HSS	4 - 5 mm	0,5 mm		1	792556-4	0088381117555	25,00
24 HSS	- de 4 mm	0,5 mm		1	194692-6	0088381350815	22,00
10 HSS	+ de 5,5 mm	0,5 mm		1	B-30128	0088381417846	19,00

Corte MADERA

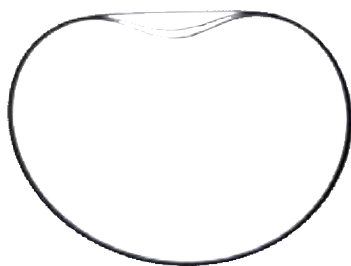

Madera		Velocidad		Espesor (mm)	Material	Dientes por pulgada	Unds.	Código	EAN	P.V.P. (€)
Con clavo	Sin clavo	Alta	Baja							
1	1	1	-	0,5	Acero al carbono	6	3	792567-9	0088381117579	40,00

Sierras de cinta para LB1200F (2.240mm)



Aplicación	Material	Espesor (mm)	Dientes por pulgada	Ancho de la hoja (mm)	Unds.	Código	EAN	P.V.P. (€)
Madera corte transversal	Acero al carbono	0,5	4	16	3	B-16667	0088381366731	60,00
Madera corte universal		0,5	4	13	3	B-16673	0088381366748	50,00
Madera corte curvo		0,5	6	6	3	B-16689	0088381366755	49,00
Metales no ferrosos		0,5	14	16	3	B-16695	0088381366762	66,00



Sierras de cinta para DPB181 - DPB182 - DPB183 (835mm)



Aplicación	Material	Espesor	Dientes por pulgada	Ancho de la hoja (mm)	Unds.	Código	EAN	P.V.P. (€)
Plásticos, metales no ferrosos, hierro, inoxidable	Bi-Metal	0,5	14	13	5	B-40543	0088381438377	51,00
		0,5	18	13	5	B-40559	0088381438384	51,00
		0,5	24	13	5	B-40565	0088381438391	50,00

Sierras para DSD180 - SD100D



Aplicación	Unds.	Código	EAN	P.V.P. (€)
Tabiquería seca*	2	B-49703	0088381460934	22,00
Madera	2	B-49719	0088381460941	29,00

* Perfecta para realizar cajeados en tabiquería seca.



Makita



SopORTE de lijas LB1200F



Unds.	Código	EAN	P.V.P. (€)
1	JM21000330	0088381374170	16,00

Guía paralela para LB1200F



Unds.	Código	EAN	P.V.P. (€)
1	JM21080230	3240890352613	21,00

Guía angular



Unds.	Código	EAN	P.V.P. (€)
1	JM21080260	3240890352620	11,60

Extensión de mesa para LB1200F



Unds.	Código	EAN	P.V.P. (€)
1	JM21000300	0088381374156	89,00

Set para corte circular para LB1200F

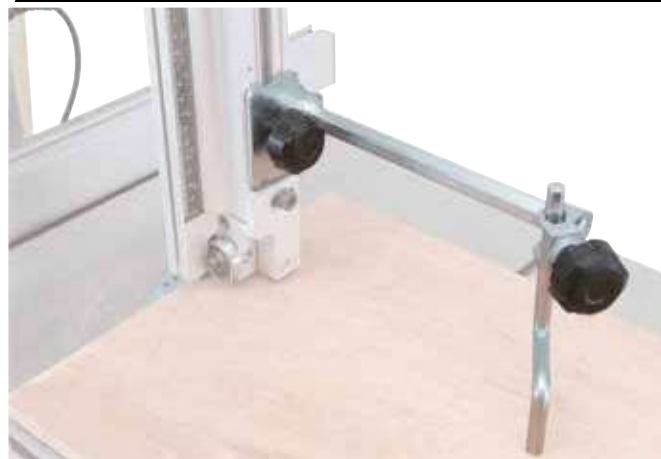

Unds.	Código	EAN	P.V.P. (€)
1	JM21000320	0088381374163	25,00

Toma de aspiración



Unds.	Código	EAN	P.V.P. (€)
1	JM27000090	3240890357519	0,80



Soporte y protector para 2107FK



Protector



Soporte



Descripción	Unds.	Código	EAN	P.V.P. (€)
Protector	1	196325-9	0088381431576	116,00
Soporte	1	194026-3	0088381194662	685,00



Tope de profundidad

Pasta lubricante



Fijo

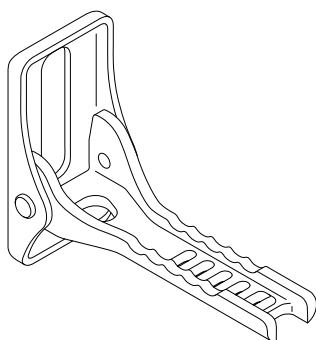

Móvil



Modelo	Tipo	Unds.	Código	EAN	P.V.P. (€)
JR3050T JR3060T	Fijo (equipo básico)	1	165396-7	-	6,10
JR3070CT	Fijo (equipo básico)	1	165406-0	-	5,40
JR3070CT	Móvil (opcional)	1	163453-5	-	7,60



Unds.	Código	EAN	P.V.P. (€)
1	191897-9	0088381117319	12,10



Sierras de calar



Sierras de calar 18V con motor BL sin escobillas.



DJV182 y DJV181

**BL
MOTOR**



**Velocidad variable.
Colector de polvo con posibilidad de conectar a nuestra gama de aspiradores.**



Sistema pendular en 4 posiciones, para cortes rápidos.













LXT
Litho-Ion EXTREMA TECNOLOGIA
Лити-ион ЭКСТРЕМА ТЕХНОЛОГИЯ

Explicación de símbolos y materiales

Materiales

	Madera		Corte imperfecto
	Madera con clavos		Corte perfecto
	Aglomerado		Aluminio
	Parquet laminado		Acero Inoxidable
	Plástico reforzado con fibra de vidrio		Placas Sandwich
	PVC (plástico)		Cristal, cerámica
	Metal		Goma, cuero, material aislante

Tipo de hoja

		Calidad del material de la sierra		Larga vida
				Cuchilla extremadamente afilada
	Corte recto		Corte rápido	
	Corte curvo		Cuchilla doble	
	Dentado con los dientes inclinados		Combinado	



Corte Super Express



Tipo	Descripción	Dientes por pulgada	Longitud útil (mm)	Calidades material	Madera	Plástico	Aluminio	Metal inox	Metal no ferroso	Metal	Tipo Clase B	Unds. paquete	Código	EAN	P.V.P (€)
B-50	Hoja superexpress con un gran rendimiento en las caladoras a batería: madera y plásticos.	8 - 11	73	HCS	5,5	5,5	-	-	-	-	T234X	5	B-06460	0088381276702	8,60



B-51	Hoja superexpress con un gran rendimiento en las caladoras a batería: Metal	10 - 18	73	HHS	-	-	-	1,3	-	1,8	T123X	5	B-06476	0088381276719	8,60
------	---	---------	----	-----	---	---	---	-----	---	-----	-------	---	---------	---------------	------



B-52	Hoja superexpress con un gran rendimiento en las caladoras a batería: Universal	6 - 10	73	HHS	5,5	5,5	-	-	-	-	T345XF	5	B-06482	0088381276726	10,20
------	---	--------	----	-----	-----	-----	---	---	---	---	--------	---	---------	---------------	-------



-	Conjunto Super Express	-	77	HHS	-	-	-	-	-	-	-	3	B-06292	0088381249713	6,80
---	------------------------	---	----	-----	---	---	---	---	---	---	---	---	---------	---------------	------

Corte básico - Madera



B13	Para cortes en madera y plásticos	8	75	HCS	4-65	4-65	-	-	-	-	T111C	5	A-85656	0088381149563	4,50
-----	-----------------------------------	---	----	-----	------	------	---	---	---	---	-------	---	---------	---------------	------



B15	Para madera prensada y tableros de fibra de hasta 3mm, plásticos hasta 35mm.	12	50	HCS	3-35	3-35	-	-	-	-	T119B	5	A-85678	0088381149655	4,20
-----	--	----	----	-----	------	------	---	---	---	---	-------	---	---------	---------------	------



B14	Para madera prensada y tableros de fibra de hasta 8mm, plásticos hasta 35mm (corte rápido).	18	51	HCS	2-35	2-35	-	-	-	-	-	5	A-85662	0088381149648	4,20
-----	---	----	----	-----	------	------	---	---	---	---	---	---	---------	---------------	------



B18	Ideal para cortes en curva en madera y plástico	14	44	HCS	2-35	2-35	-	-	-	-	T119BO	5	A-85709	0088381149662	4,80
-----	---	----	----	-----	------	------	---	---	---	---	--------	---	---------	---------------	------



Corte rápido - Madera



Tipo	Descripción	Dientes por pulgada	Longitud útil (mm)	Calidades material	Madera	Plástico	Aluminio	Metal inox	Metal no ferroso	Metal	Tipo Clase B	Unds. paquete	Código	EAN	P.V.P (€)
B16	Para corte rápido en madera y plástico. Corte rápido y basto.	6	75	HCS	5-65	5-65	-	-	-	-	T144D	5	A-85684	0088381149686	6,00
L02	Ideal para cortes rápidos en materiales gruesos	6	100	HCS	5-90	5-90	-	-	-	-	-	5	A-86309	0088381150279	8,60
L10	Para todo tipo de cortes en madera. Corte rápido y basto.	6	151	HCS	5-135	5-135	-	-	-	-	T344D	5	A-86315	0088381150286	11,80
B17	Ideal para cortes en curva en madera y plásticos. (corte rápido).	6	70	HCS	5-60	-	-	-	-	-	T244D	5	A-85690	0088381149693	6,20
-	Corte curvo y rápido para toda clase de maderas.	6	75	HCS/CV	8-65	-	-	-	-	-	-	5	P-31572	0088381959735	8,30
-	Corte rápido en toda clase de maderas con una prolongada vida útil.	6	75	BIM	8-65	-	-	-	-	-	T144DF	5	P-31588	0088381959742	10,90

Corte maderas laminadas



Tipo	Descripción	Dientes por pulgada	Longitud útil (mm)	Calidades material	Madera	Plástico	Aluminio	Metal inox	Metal no ferroso	Metal	Tipo Clase B	Unds. paquete	Código	EAN	P.V.P (€)
B19	Para madera laminada y chapa decorativa de acabado. Dientes invertidos.	12	63	HCS	3-50	3-50	-	-	-	-	T101BR	5	A-85715	0088381149709	5,90
B28	Para madera laminada y chapa decorativa de acabado.	16	63	HSS	2-50	2-50	-	-	-	-	T101BIF	5	A-80391	0088381136938	11,20
B-53	Para corte recto en laminados, suelos de madera y maderas decorativas. Sin astillas.	15	82	-	-	-	-	-	-	-	T101BIF	5	B-10970	0088381351461	13,60
B-54	Para corte curvo en laminados, suelos de madera y maderas decorativas. Sin astillas.	15	82	-	-	-	-	-	-	-	T101AOF	5	B-10986	0088381351478	15,90
B16	Hoja especial para cortes en superficie sin astillas, en laminado y parquet	12	60	BIM	5-20	-	-	-	-	-	T101AIF	5	P-31566	0088381959728	11,20



Corte limpio madera

Tipo	Descripción	Dientes por pulgada	Longitud útil (mm)	Calidades material	Madera	Plástico	Aluminio	Metal inox	Metal no ferroso	Metal	Tipo Clase B	Unds. paquete	Código	EAN	P.V.P (€)
N59	Corte rápido y limpio en toda clase de madera y plástico..	8	75	HCS	4-65	4-65	-	-	-	-	T101B	5	A-86583	0088381150934	7,80
B10	Corte rápido y limpio en madera y plásticos, especialmente indicado para madera contrachapada.	9	75	HCS	3-65	3-65	-	-	-	-	-	5	A-85628	0088381149716	6,60
B11	Para terminación de trabajos rápido. Corte limpio.	9	75	HCS	3-60	3-60	-	-	-	-	T101B	5	A-85634	0088381149549	7,00
B12	Para terminación de trabajos rápido. Corte limpio.	6	75	HCS	5-65	5-65	-	-	-	-	T101D	5	A-85640	0088381149556	5,60
L01	Hoja gruesa y larga para cortes limpios y rectos.	6	100	HCS	5-90	5-90	-	-	-	-	T301CD	5	A-86290	0088381150262	12,40
B29	Ideal para corte curvo para madera y plásticos. (acabado).	16	42	HCS	2-35	2-35	-	-	-	-	T101AO	5	A-80400	0088381136945	10,60
BR13	Corte sin astillas en madera, no requieren lijado. La hoja corta hacia arriba y abajo para un buen acabado de la superficie.	9	64	HCS	5-65	-	-	-	-	-	-	5	A-85793	0088381149679	4,80
-	Corte limpio en toda clase de madera y plástico con una prolongada vida útil.	10	75	BIM	5-65	5-65	-	-	-	-	T101BF	5	P-31594	00883811959759	11,40

Corte - Maderas duras

Tipo	Descripción	Dientes por pulgada	Longitud útil (mm)	Calidades material	Madera	Plástico	Aluminio	Metal inox	Metal no ferroso	Metal	Tipo Clase B	Unds. paquete	Código	EAN	P.V.P (€)
B25	Para madera dura, para chapa.	9	75	HSS	3-60	3-60	3-6	-	-	3-6	T127D	5	A-85765	0088381149600	5,60
B26	Para cortes curvos en madera dura, metal, metal no ferroso y plásticos duros.	9	70	HSS	3-60	3-60	3-10	-	3-10	3-10	T227D	5	A-85771	0088381149617	6,30



Corte - Madera con clavo



Tipo	Descripción	Dientes por pulgada	Longitud útil (mm)	Calidades material	Madera	Plástico	Aluminio	Metal inox	Metal no ferroso	Metal	Tipo Clase B	Unds. paquete	Código	EAN	P.V.P (€)
M-Force	Diente en M para el corte rápido de madera, metales y madera con clavo. Corta en las dos direcciones para aumentar la velocidad de corte.	5	130	BIM	105	-	-	-	-	-	-	2	P-45749	0088381976183	8,60



-	Ideal para madera con clavo.	9-10	105	BIM	5-95	-	-	-	-	2,5-10	-	5	P-49638	0088381980081	12,60
---	------------------------------	------	-----	-----	------	---	---	---	---	--------	---	---	---------	---------------	-------



-	Ideal para madera con clavo.	9-10	75	BIM	5-65	-	-	-	-	2,5-10	T111HF	5	P-49622	0088381980074	11,20
---	------------------------------	------	----	-----	------	---	---	---	---	--------	--------	---	---------	---------------	-------

Corte básico - Metal



Tipo	Descripción	Dientes por pulgada	Longitud útil (mm)	Calidades material	Madera	Plástico	Aluminio	Metal inox	Metal no ferroso	Metal	Tipo Clase B	Unds. paquete	Código	EAN	P.V.P (€)
N51	Para chapa fina de acero y acero inoxidable.	24	75	HSS	-	1,5-6	1,5-6	1-3	-	1-3	-	5	A-86561	0088381150910	7,40



B22	Para acero medio, inoxidable y plásticos duros, especialmente indicado para chapa fina.	24	50	HSS	-	1-6	1-3	1-3	-	1-3	T118A	5	A-85737	0088381149570	5,60
-----	---	----	----	-----	---	-----	-----	-----	---	-----	-------	---	---------	---------------	------



B24	Para acero medio fino, inoxidable y chapas de acero muy finas.	32	50	HSS	-	1-3	1-2	0,5-2	-	0,5-2	T118G	5	A-85759	0088381149594	5,40
-----	--	----	----	-----	---	-----	-----	-------	---	-------	-------	---	---------	---------------	------



B23	Acero medio, chapa de espesor medio, madera, chapa de madera decorativa y acero no ferroso.	14	50	HSS	3-35	3-35	2-6	-	2-6	2-6	T118B	5	A-85743	0088381149587	5,40
-----	---	----	----	-----	------	------	-----	---	-----	-----	-------	---	---------	---------------	------



B27	Para cortes curvos en acero medio y no ferroso.	24	50	HSS	-	1-6	1-3	1-3	1-3	1-3	T218A	5	A-85787	0088381149631	6,80
-----	---	----	----	-----	---	-----	-----	-----	-----	-----	-------	---	---------	---------------	------

Corte - Metal

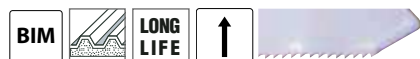

Tipo	Descripción	Dientes por pulgada	Longitud útil (mm)	Calidades material	Madera	Plástico	Aluminio	Metal inox	Metal no ferroso	Metal	Tipo Clase B	Unds. paquete	Código	EAN	P.V.P (€)
-	Para revestimiento de 80mm y materiales de sandwich. (hoja flexible)	25	105	BIM	-	-	-	-	-	1-3	T318AF	5	P-47204	0088381977630	10,60



-	Para tubería fina de materiales no ferrosos y revestimientos.	13	105	BIM	-	-	-	-	2,5-6	2,5-6	T318BF	5	P-47210	0088381977647	10,00
---	---	----	-----	-----	---	---	---	---	-------	-------	--------	---	---------	---------------	-------



-	Hoja flexible para chapa fina de acero medio e inoxidable con una prolongada vida útil.	21	55	BIM	-	-	-	1,2-2	-	1,2-2	T118AF	5	P-47226	0088381977654	8,30
---	---	----	----	-----	---	---	---	-------	---	-------	--------	---	---------	---------------	------

Corte - Especial Inox



Tipo	Descripción	Dientes por pulgada	Longitud útil (mm)	Calidades material	Madera	Plástico	Aluminio	Metal inox	Metal no ferroso	Metal	Tipo Clase B	Unds. paquete	Código	EAN	P.V.P (€)
-	Para acero medio e inoxidable	24	50	CV-HM	-	-	1,5-3	1,5-3	-	1,5-3	T118A-HM	1	P-05929	0088381944441	14,30



-	Hoja flexible para aceros medio e inoxidable, metal no ferroso con una prolongada vida útil	14	55	BIM	-	-	2-3	2-3	-	2-3	T118BF	5	P-47232	0088381977661	8,30
---	---	----	----	-----	---	---	-----	-----	---	-----	--------	---	---------	---------------	------

Corte - Especial plásticos



Tipo	Descripción	Dientes por pulgada	Longitud útil (mm)	Calidades material	Madera	Plástico	Aluminio	Metal inox	Metal no ferroso	Metal	Tipo Clase B	Unds. paquete	Código	EAN	P.V.P (€)
B21	Para trabajos de acabado en plásticos y aluminio.	12	75	HSS	-	3-60	1-10	-	-	-	T101A	5	A-85721	0088381149624	9,00

Corte - Especial materiales blandos



Tipo	Descripción	Dientes por pulgada	Longitud útil (mm)	Calidades material	Madera	Plástico	Aluminio	Metal inox	Metal no ferroso	Metal	Tipo Clase B	Unds. paquete	Código	EAN	P.V.P (€)
-	Ideal para cartar papel, corcho, goma y cuero.	-	75	HCS	-	-	-	-	-	-	T113A	5	A-80416	0088381136952	17,70

Corte - Especial cerámica y fibra de vidrio



Tipo	Descripción	Dientes por pulgada	Longitud útil (mm)	Calidades material	Madera	Plástico	Aluminio	Metal inox	Metal no ferroso	Metal	Tipo Clase B	Unds. paquete	Código	EAN	P.V.P (€)
-	Para cerámica de 5 - 15mm corte basto.	-	54	CV-HM	-	-	-	-	-	-	T130RI-FF	3	P-38788	0088381966696	15,50



-	Para cerámica de grueso 5 - 20mm corte fino.	-	54	CV-HM	-	-	-	-	-	-	T150RI-FF	3	P-38794	0088381966702	15,50
---	--	---	----	-------	---	---	---	---	---	---	-----------	---	---------	---------------	-------



-	Para fibra de vidrio y plásticos reforzados. Dientes de carburo de tungsteno.	6	75	CV-HM	10-60	-	-	-	-	-	T141HM	3	B-06890	0088381289177	26,00
---	---	---	----	-------	-------	---	---	---	---	---	--------	---	---------	---------------	-------



-	Para fibra de vidrio y plásticos reforzados. Dientes de carburo de tungsteno.	6	105	CV-HM	10-95	-	-	-	-	-	T341HM	3	B-06909	0088381289184	35,00
---	---	---	-----	-------	-------	---	---	---	---	---	--------	---	---------	---------------	-------

Corte - Especial panel sandwich



Tipo	Descripción	Dientes por pulgada	Longitud útil (mm)	Calidades material	Madera	Plástico	Aluminio	Metal inox	Metal no ferroso	Metal	Tipo Clase B	Unds. paquete	Código	EAN	P.V.P (€)
-	Ideal para cartar papel, corcho, goma y cuero.	24	155	BIM	5-145	5-145	-	-	-	-	T718BF	5	P-49644	0088381980098	14,30

Conjuntos de hojas a granel

Para corte rápido y limpio en madera y plásticos. Especial madera contrachapada



Tipo	Descripción	Dientes por pulgada	Longitud útil (mm)	Calidades material	Madera	Plástico	Aluminio	Metal inox	Metal no ferroso	Metal	Tipo Clase B	Unds. paquete	Código	EAN	P.V.P (€)
B10	Conjunto de hojas a granel	9	75	HCS	3-65	3-65	-	-	-	-	T301CD	100	B-07674	0088381335294	106,00

Para terminación de trabajos rápido. Corte limpio



Tipo	Descripción	Dientes por pulgada	Longitud útil (mm)	Calidades material	Madera	Plástico	Aluminio	Metal inox	Metal no ferroso	Metal	Tipo Clase B	Unds. paquete	Código	EAN	P.V.P (€)
B11	Conjunto de hojas a granel	9	75	HCS	3-60	3-60	-	-	-	-	T101B	100	B-07680	0088381335300	111,00

Para corte rápido en madera y plásticos. Corte rápido y basto



Tipo	Descripción	Dientes por pulgada	Longitud útil (mm)	Calidades material	Madera	Plástico	Aluminio	Metal inox	Metal no ferroso	Metal	Tipo Clase B	Unds. paquete	Código	EAN	P.V.P (€)
B16	Conjunto de hojas a granel	6	75	HCS	5-65	5-65	-	-	-	-	T144D	100	B-07711	0088381335331	94,00

Para acero medio, inoxidable y plásticos duros. Indicado para chapa fina



Tipo	Descripción	Dientes por pulgada	Longitud útil (mm)	Calidades material	Madera	Plástico	Aluminio	Metal inox	Metal no ferroso	Metal	Tipo Clase B	Unds. paquete	Código	EAN	P.V.P (€)
B22	Conjunto de hojas a granel	24	50	HSS	-	1-6	1-3	1-3	-	1-3	T118A	100	B-07733	0088381335355	90,00

Para cortes en madera y plásticos



Tipo	Descripción	Dientes por pulgada	Longitud útil (mm)	Calidades material	Madera	Plástico	Aluminio	Metal inox	Metal no ferroso	Metal	Tipo Clase B	Unds. paquete	Código	EAN	P.V.P (€)
B13	Conjunto de hojas a granel	8	80	HCS	4-65	4-65	-	-	-	-	T111C	100	B-07705	0088381335324	73,00



Tipos de hojas - Inserción Makita

Corte - Madera



Tipo	Descripción	Dientes por pulgada	Longitud útil (mm)	Calidades material	Madera	Plástico	Aluminio	Metal inox	Metal no ferroso	Metal	Tipo Clase B	Unds. paquete	Código	EAN	P.V.P (€)
3	Para toda clase de maderas y plásticos.	9	60	HCS	3-50	3-50	-	-	-	-	-	5	A-85868	88381149457	4,80

Corte rápido - Madera



Tipo	Descripción	Dientes por pulgada	Longitud útil (mm)	Calidades material	Madera	Plástico	Aluminio	Metal inox	Metal no ferroso	Metal	Tipo Clase B	Unds. paquete	Código	EAN	P.V.P (€)
8	Corte rápido en toda la clase de maderas y plásticos.	8	60	HCS	4-50	4-50	-	-	-	-	-	5	A-85911	88381149723	5,90

Corte acabado - Madera



Tipo	Descripción	Dientes por pulgada	Longitud útil (mm)	Calidades material	Madera	Plástico	Aluminio	Metal inox	Metal no ferroso	Metal	Tipo Clase B	Unds. paquete	Código	EAN	P.V.P (€)
9	Corte limpio y rápido en toda la clase de madera y plásticos.	8	60	HCS	4-50	4-50	-	-	-	-	-	5	A-85927	0088381149730	7,50



Tipo	Descripción	Dientes por pulgada	Longitud útil (mm)	Calidades material	Madera	Plástico	Aluminio	Metal inox	Metal no ferroso	Metal	Tipo Clase B	Unds. paquete	Código	EAN	P.V.P (€)
10	Corte limpio y rápido en toda las clase de madera y plásticos. Especial para Plywood.	9	60	HCS	4-50	4-50	-	-	-	-	-	5	A-85818	0088381149488	7,80



Tipo	Descripción	Dientes por pulgada	Longitud útil (mm)	Calidades material	Madera	Plástico	Aluminio	Metal inox	Metal no ferroso	Metal	Tipo Clase B	Unds. paquete	Código	EAN	P.V.P (€)
BR3	Hoja especial para cortes de la superficie sin astillas.	9	60	HCS	4-50	-	-	-	-	-	-	5	A-85933	0088381149747	4,80

Corte - Maderas duras y contrachapados decorativos



Tipo	Descripción	Dientes por pulgada	Longitud útil (mm)	Calidades material	Madera	Plástico	Aluminio	Metal inox	Metal no ferroso	Metal	Tipo Clase B	Unds. paquete	Código	EAN	P.V.P (€)
2	Para chapas finas de acero e inoxidable.	14	60	HSS	3-50	3-50	2-6	-	2-6	-	-	5	A-85852	0088381149440	5,90



Tipo	Descripción	Dientes por pulgada	Longitud útil (mm)	Calidades material	Madera	Plástico	Aluminio	Metal inox	Metal no ferroso	Metal	Tipo Clase B	Unds. paquete	Código	EAN	P.V.P (€)
4	Para madera dura, metal no ferroso y plásticos duros.	9	60	HSS	3-50	3-50	3-6	-	3-6	-	-	5	A-85874	0088381149464	5,90

Corte - Madera



Tipo	Descripción	Dientes por pulgada	Longitud útil (mm)	Calidades material	Madera	Plástico	Aluminio	Metal inox	Metal no ferroso	Metal	Tipo Clase B	Unds. paquete	Código	EAN	P.V.P (€)
41	Para corte de madera y plástico sin astillas. Dientes invertidos.	12	60	HSS	3-50	3-50	-	-	-	-	-	5	A-85880	0088381149525	6,20



42	Hoja especial sin inclinación para un buen acabado de ambos lados, laminados y tableros múltiples.	16	60	HSS	2-50	-	-	-	-	-	-	5	A-85896	0088381149532	9,60
----	--	----	----	-----	------	---	---	---	---	---	---	---	---------	---------------	------



Corte - Metal



Tipo	Descripción	Dientes por pulgada	Longitud útil (mm)	Calidades material	Madera	Plástico	Aluminio	Metal inox	Metal no ferroso	Metal	Tipo Clase B	Unds. paquete	Código	EAN	P.V.P (€)
1	Para chapas finas de acero e inoxidable.	24	60	HSS	-	-	1-3	0,5-3	1-3	-	-	5	A-85802	0088381149433	5,90



5	Para chapas finas de acero e inoxidable.	24	42	HSS	-	-	1-3	1-3	1-3	-	-	5	A-85905	0088381149471	6,50
---	--	----	----	-----	---	---	-----	-----	-----	---	---	---	---------	---------------	------



Guías de carril y accesorios



Pieza para unir dos carriles



Guía carril



Funda para carril guía

Descripción	Longitud (m)	Unds.	Código	EAN	P.V.P (€)
Pieza para unir dos carriles	-	1	198885-7	0088381497046	27,00
Guía carril	1	1	199140-0	0088381528672	48,00
	1,4	1	194368-5	0088381313353	76,00
	1,9	1	194925-9	0088381354790	117,00
	3	1	194367-7	0088381335201	198,00
Funda para carril guía	1	1	E-05670	0088381567183	49,00
	1,4	1	E-05664	0088381567176	57,00
	1,9	1	E-10920	0088381581523	89,00
	3	1	E-10936	0088381581530	110,00

Adaptador para guía de carril



Modelos	Unds.	Código	EAN	P.V.P (€)
4350T / CT / FCT 4351CT / FCT 4329 DJV180 / 181 / 182 JV0600	1	193517-1	0088381170659	32,00

Llaves allen



Modelos	Unds.	Código	EAN	P.V.P (€)
4326 4327 4328 4329	1	783201-2	0088381101288	1,10
4350T/CT/FCT 4351T/CT/FCT DJV180 / 181 / 182	1	783202-0	0088381102667	1,10

Mordaza para carril guía



Modelos	Unds.	Código	EAN	P.V.P (€)
Guías de carril	2	194385-5	0088381314084	30,00

Guía lateral + circular (A + B)



Tipo	Modelo	Unds.	Código	EAN	P.V.P (€)
A + B	DJV180 DJV181 DJV182	1	193516-3	0088381170666	10,20
A + B	4326 4327 4328 4329 JV0600 JV100D JV103	1	192732-4	0088381148054	8,80

Accesorios

Placa antiastillamiento



415524-7

Protector de base



417852-6

Adaptador de aspiración



417853-4

Adaptador de aspiración



192349-3

Tipo	Modelo	Unds.	Código	EAN	P.V.P (€)
Placa antiastillamiento	DJV182 4350T/CT/FCT 4351CT/FCT	1	415524-7	0088381131681	0,80
	4322 4323 4324	1	416477-3	0088381148207	0,55
	4329 4350T/CT/FCT 4351T/CT/FCT, DJV180 / 181 / 182 JV0600	1	417852-6	0088381177498	2,80
Adaptador de aspiración	4326 4327 4328 4329 JV0600	1	192349-3	0088381126229	8,20
	4350T/CT/FCT 4351CT/FCT DJV180	1	417853-4	0088381170833	1,10

Fresado



Fresas - Índice

Fresas rectas



Fresas molduradoras con rodamiento 2 filos



Fresas para paneles con rodamientos



Fresas biseladoras con rodamiento 2 filos



Fresas ranuradoras



Fresas molduradoras con rodamiento 2 filos



Fresas biseladoras



Estuches de fresas



Fresas cola milano



Fresas para taladrar aluminio



Fresas redondeadoras



Fresas para tabiquería seca



Fresas redondeadoras de cantos con rodamiento



Fresas TCT



Fresas rectas 1 filo

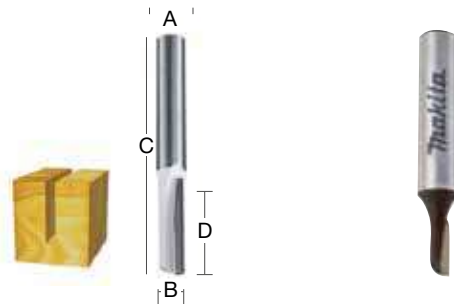

A (mm)	B (mm)	C (mm)	D (mm)	Unds.	Código	EAN	P.V.P (€)
8,0	6,0	50,8	19,0	1	D-67692	0088381549592	5,60
6,0	6,0	50,8	19,0	1	D-67701	0088381549608	5,60

Fresas rectas 2 filos

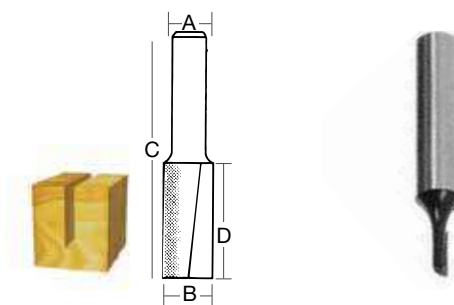

A (mm)	B (mm)	C (mm)	D (mm)	Unds.	Código	EAN	P.V.P (€)
6,0	6,0	48,0	16,0	1	D-67717	0088381549615	5,90
6,0	8,0	51,0	19,0	1	D-67739	0088381549639	6,70
6,0	8,0	57,1	25,4	1	D-67745	0088381549646	6,40
6,0	10,0	57,4	25,4	1	D-67751	0088381549653	6,70
6,0	12,0	64,0	32,0	1	D-67767	0088381549660	8,60
6,0	14,0	51,0	19,0	1	D-67773	0088381549677	7,80
6,0	20,0	50,8	19,0	1	D-67789	0088381549684	10,40
8,0	6,0	51,0	19,0	1	D-67804	0088381549707	6,20
8,0	8,0	51,0	19,0	1	D-67810	0088381549714	6,70
8,0	10,0	51,0	19,0	1	D-67826	0088381549721	7,00
8,0	12,0	51,0	19,0	1	D-67832	0088381549738	6,70
8,0	14,0	51,0	19,0	1	D-67848	0088381549745	8,00
8,0	16,0	50,8	19,0	1	D-67854	0088381549752	8,80
8,0	18,0	50,8	19,0	1	D-67860	0088381549769	10,20
8,0	20,0	50,8	19,0	1	D-67876	0088381549776	10,40
8,0	22,0	57,2	25,4	1	D-67882	0088381549783	11,50
8,0	24,0	57,2	25,4	1	D-67898	0088381549790	14,40
12,0	8,0	69,8	25,0	1	D-67907	0088381549806	7,50
12,0	10,0	69,8	25,4	1	D-67913	0088381549813	7,80
12,0	12,0	73,0	32,0	1	D-67929	0088381549820	8,80
12,0	14,0	73,0	32,0	1	D-67935	0088381549837	10,20
12,0	16,0	73,0	32,0	1	D-67941	0088381549844	11,00
12,0	19,0	73,0	32,0	1	D-67957	0088381549851	13,10
12,0	22,0	73,0	32,0	1	D-67963	0088381549868	14,40
12,0	25,0	73,0	32,0	1	D-67979	0088381549875	15,50

Fresas para madera HM/CT

Fresas para paneles con rodamiento 2 filos

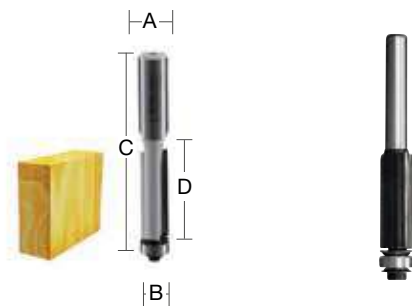

A (mm)	B (mm)	C (mm)	D (mm)	Unds.	Código	EAN	P.V.P (€)
6,0	9,5	66,9	26,0	1	D-67985	0088381549882	7,80
8,0	12,7	55,5	13,0	1	D-68024	0088381549929	8,00
8,0	12,7	68,5	26,0	1	D-68030	0088381549936	8,30

Fresas para paneles con rodamiento 3 filos

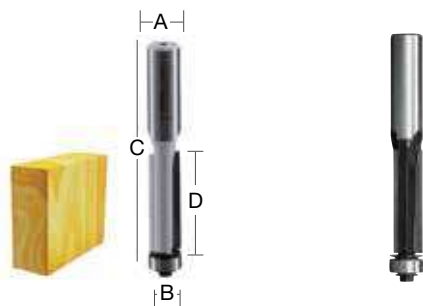

A (mm)	B (mm)	C (mm)	D (mm)	Unds.	Código	EAN	P.V.P (€)
8,0	12,7	68,5	26,0	1	D-68046	0088381549943	11,80
12,0	12,7	91,2	38,0	1	D-68052	0088381549950	14,20

Fresas ranuradoras 2 filos

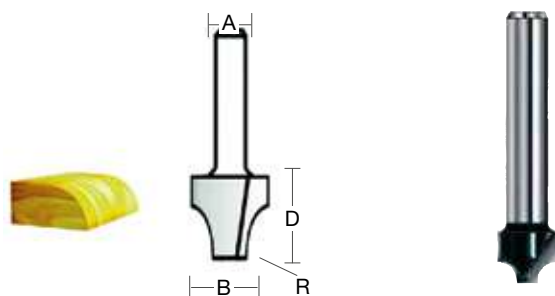

A (mm)	B (mm)	C (mm)	D (mm)	R (mm)	Unds.	Código	EAN	P.V.P (€)
6,0	6,4	44,5	12,7	3,2	1	D-68096	0088381549998	5,90

Fresas biseladoras 2 filos 90°

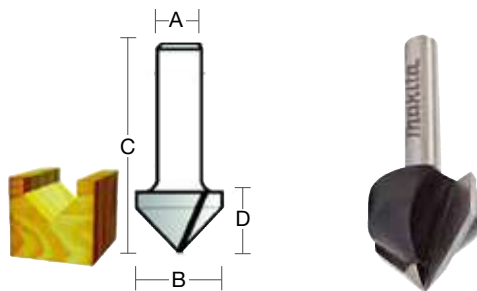

A (mm)	B (mm)	C (mm)	D (mm)	Unds.	Código	EAN	P.V.P (€)
6,0	19,0	47,7	16,0	1	D-68177	0088381550079	8,80
8,0	12,7	44,7	12,7	1	D-68183	0088381550086	7,00
8,0	15,9	44,0	12,7	1	D-68199	0088381550093	7,80
12,0	12,7	54,0	12,7	1	D-68208	0088381550109	7,20
12,0	15,9	50,8	12,7	1	D-68214	0088381550116	8,00
8,0	19,0	47,6	16,0	1	D-68220	0088381550123	8,80
12,0	19,0	57,1	16,0	1	D-68236	0088381550130	13,40
12,0	28,6	60,3	22,2	1	D-68242	0088381550147	18,70

Fresas cola milano 2 filos

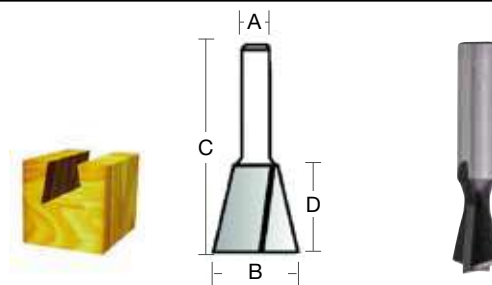

A (mm)	B (mm)	C (mm)	D (mm)	Ang.	Unds.	Código	EAN	P.V.P (€)
8,0	12,7	45,0	13,0	14°	1	D-68323	0088381550222	6,70
8,0	15,0	52,0	14,3	15°	1	D-68339	0088381550239	8,00
12,0	19,0	63,5	22,2	7°	1	D-68345	0088381550246	10,40
12,0	25,4	64,0	22,2	14°	1	D-68351	0088381550253	12,60

Fresas redondeadoras canto 2 filos

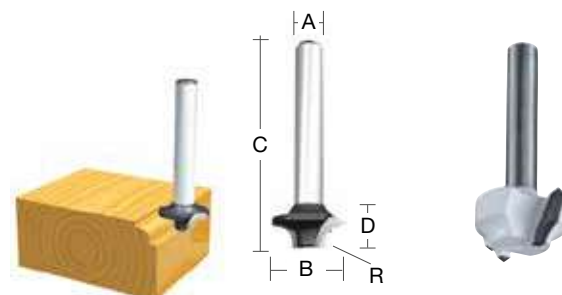

A (mm)	B (mm)	C (mm)	D (mm)	R (mm)	Unds.	Código	EAN	P.V.P (€)
6,0	19,0	42,5	9,5	3,2	1	D-68373	0088381550277	7,50
6,0	25,4	45,5	13,5	6,4	1	D-68389	0088381550284	11,20



Fresas para madera

Fresas redondeadoras de cantos con rodamiento 2 filos

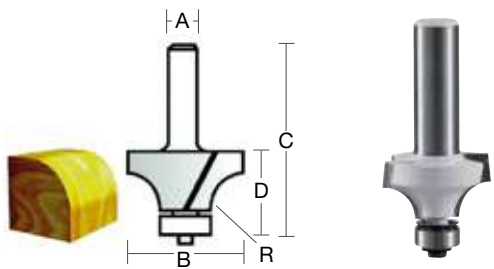

A (mm)	B (mm)	C (mm)	D (mm)	R (mm)	Unds.	Código	EAN	P.V.P (€)
6,0	19,0	53,4	9,5	3,2	1	D-68395	0088381550291	9,40
6,0	25,4	56,4	13,5	6,4	1	D-68410	0088381550314	13,10
6,0	31,8	59,7	16,7	9,5	1	D-68432	0088381550338	16,60
8,0	19,0	53,4	9,5	3,2	1	D-68454	0088381550352	9,40
8,0	25,4	56,4	13,5	6,4	1	D-68482	0088381550383	13,10
8,0	31,8	59,7	16,7	9,5	1	D-68507	0088381550406	16,60

Fresas molduradoras con rodamiento 2 filos

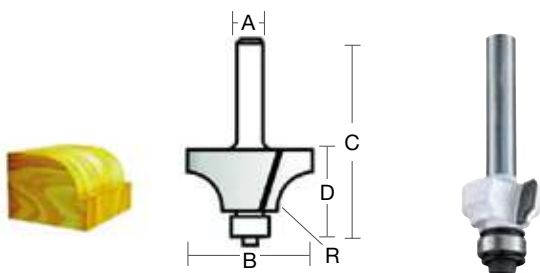

A (mm)	B (mm)	C (mm)	D (mm)	R (mm)	Unds.	Código	EAN	P.V.P (€)
6,0	20,3	50,5	10,0	4,0	1	D-68557	0088381550451	11,50
6,0	22,2	53,2	12,7	4,8	1	D-68563	0088381550468	11,80
6,0	28,6	55,5	14,5	7,9	1	D-68579	0088381550475	14,20
8,0	19,0	51,6	9,5	3,2	1	D-68591	0088381550499	9,40
8,0	31,8	57,9	17,0	9,5	1	D-68622	0088381550529	16,60

Fresas molduradoras con rodamiento 2 filos

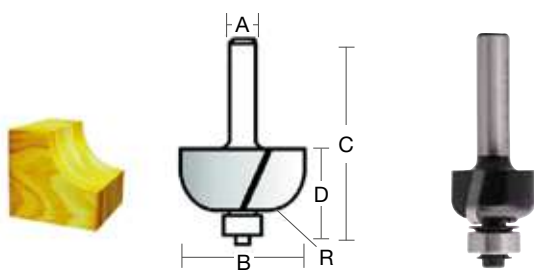

A (mm)	B (mm)	C (mm)	D (mm)	R (mm)	Unds.	Código	EAN	P.V.P (€)
8,0	22,2	55,6	12,7	4,8	1	D-68666	0088381550567	11,20

Fresas biseladoras con rodamiento 2 filos

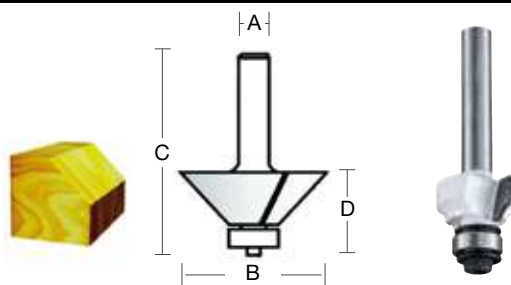

A (mm)	B (mm)	C (mm)	D (mm)	Ang.	Unds.	Código	EAN	P.V.P (€)
6,0	25,4	51,0	11,0	45°	1	D-68694	0088381550598	12,80
6,0	22,2	56,1	12,7	25°	1	D-68703	0088381550604	10,70
8,0	30,2	54,7	12,7	45°	1	D-68719	0088381550611	15,20
12,0	44,5	68,6	22,6	45°	1	D-68753	0088381550659	24,00

Fresas molduradoras con rodamiento 2 filos

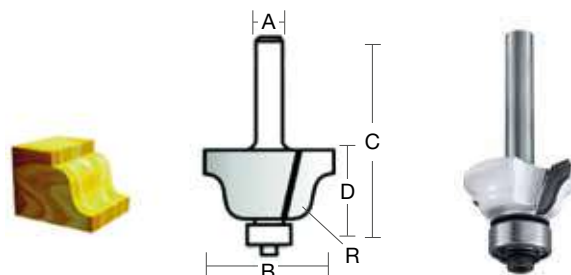

A (mm)	B (mm)	C (mm)	D (mm)	R (mm)	Unds.	Código	EAN	P.V.P (€)
6,0	28,6	55,3	13,0	4,0	1	D-68775	0088381550673	12,30
8,0	28,6	55,3	13,0	4,0	1	D-68781	0088381550680	13,10

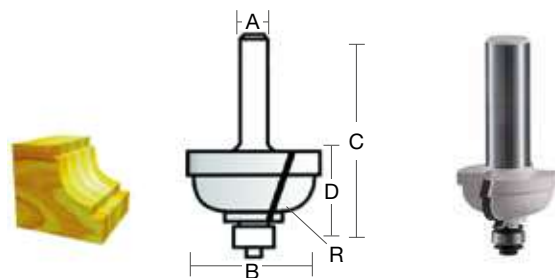

A (mm)	B (mm)	C (mm)	D (mm)	R (mm)	Unds.	Código	EAN	P.V.P (€)
6,0	25,4	53,7	12,7	4,8	1	D-68806	0088381550703	13,60

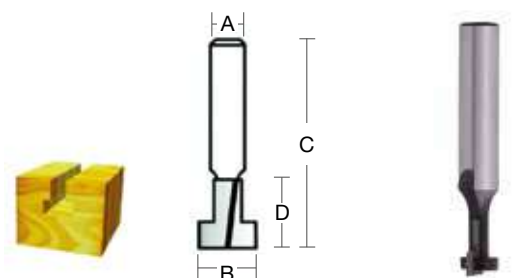

A (mm)	B (mm)	C (mm)	D (mm)	Unds.	Código	EAN	P.V.P (€)
8,0	9,5	48,0	10,5	1	D-68812	0088381550710	5,90

Fresas para madera

Blíster de fresas

- Estuches con diferentes tipos de fresas para diversas aplicaciones.

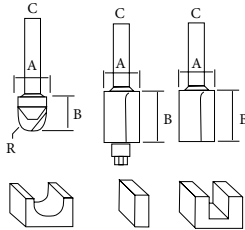

A (mm)	B (mm)	C (mm)	Tipo	Unds.	Código	EAN	P.V.P (€)
-	-	6	HM	3	D-30209	88381352772	23,00
-	-	6	HM				
-	-	6	HM				

Juego fresas multiusos (22pcs)



D	A (mm)	B (mm)	C (mm)	R (mm)	Filos	Unds.	Código	EAN	P.V.P (€)
51	20	19	8	-	2	22	D-74778	0088381590228	214,00
51	16	19	8	-	2				
51	12	19	8	-	2				
51	10	19	8	-	2				
51	8	19	8	-	2				
51	6	19	8	-	1				
51	4	13	8	-	1				
51	3	13	8	-	1				
51	17,3	8	8	2,3	2				
53,4	19	9,5	8	3,2	2				
56,5	25,4	13,5	8	6,35	2				
55	22,2	12,7	8	4,8	2				
54,5	30,2	12,7	8	-	2				
55,6	22,2	12,7	8	4,8	2				
41,5	12,7	10	8	6,35	2				
48	12,7	16	8	-	2				
44,7	12,7	12,7	8	-	2				
67	9,5	26	8	-	2				
68,5	12,7	26	8	-	2				
52	15	14,3	8	-	2				
54,6	31,8	12,2	8	-	2				
65	6,35	19	8	-	1				



Juego fresas multiusos (22pcs)



D	A (mm)	B (mm)	C (mm)	R (mm)	Filos	Unds.	Código	EAN	P.V.P (€)
51	12	19	8	-	2	22	D-74784	0088381590235	144,00
51	10	19	8	-	2				
51	8	19	8	-	2				
51	6	19	8	-	2				
48	6	16	8	-	2				
51	6	19	8	-	1				
48	5	13	8	-	1				
38,3	6,35	6,35	8	3,2	2				
40	7,9	8	8	4	2				
41,5	12,7	10	8	6,35	2				
41,3	9,5	9,5	8	4,8	2				
48	12,7	16	8	-	2				
44,7	12,7	12,7	8	-	2				
67	9,5	23	8	-	2				
45	12,7	13	8	-	2				
40	9,5	9,5	8	-	2				
63,5	6,35	8	8	-	2				
65	6,35	19	8	-	1				
44,5	6,35	12,7	8	3,2	2				
44,5	9,5	12,7	8	4,8	2				
48	9,5	10,5	8	-	2				
41,3	9,5	8,3	8	4,8	2				



Fresas para madera

Estuches de fresas

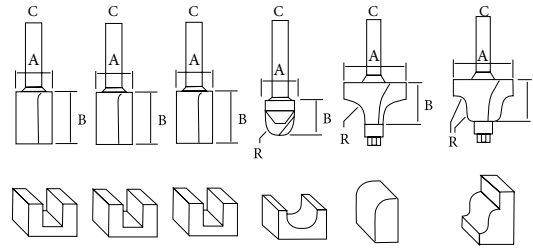

A (mm)	B (mm)	C (mm)	Unds.	Código	EAN	P.V.P (€)
6	16	8	12	D-53556	0088381449922	137,00
16	19	8				
12,7	13	8				
12,7	10	8				
12,7	16,7	8				
12,7	13,5	8				
12	19	8				
12,7	13	8				
12,7	12,7	8				
-	13,5	8				
-	14	8				
-	13	8				



A (mm)	B (mm)	C (mm)	R (mm)	Unds.	Código	EAN	P.V.P (€)
6	16	8	-	6	D-53540	0088381449915	70,00
10	19	8	-				
12	19	8	-				
12,7	10	8	6,35				
31,8	16,7	8	9,5				
28,6	13	8	4				

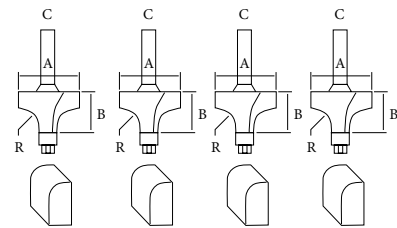

A (mm)	B (mm)	C (mm)	Unds.	Código	EAN	P.V.P (€)
6	19	6	12	D-57065	0088381459693	118,00
12	32	6				
12,7	13	6				
12,7	12,7	6				
12,7	13,5	6				
12,7	11	6				
6	16	6				
14	19	6				
6,35	12,7	6				
19	9,5	6				
-	14,5	6				
-	9,5	6				



A (mm)	B (mm)	C (mm)	R (mm)	Unds.	Código	EAN	P.V.P (€)
19	9,5	8	3,2	4	D-53534	88381449908	67,00
25,4	13,5	8	6,35				
31,8	16,7	8	9,5				
38,1	19	8	38,1				



Fresas para taladrar aluminio

- Herramienta de corte HM.
- Para perforar aluminio.
- También válida para cajeados en aluminio.

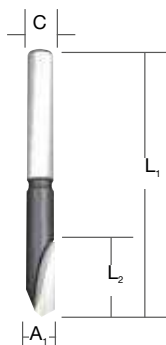

A1/ A2 (mm)	L1 (mm)	L2 (mm)	C (mm)	Tipo	Unds.	Código	EAN	P.V.P (€)
6	65	30	6	HM	1	D-16988	0088381194761	11,60



Fresas para 3706, DCO180 y DCO181

Fresas para tabiquería seca



Inserción (mm)	Modelo	Unds.	Código	EAN	P.V.P (€)
3,18 (1/8")	3706 DCO180 DCO181	1	733240-2	-	3,90
6,35 (1/4")		1	733232-1	0088381160544	11,60
3,18 (1/8") (multiuso)		1	193483-2	0088381163927	5,50



Accesorios para PJ7000 y 3901

Discos HM



Ø (mm)	Modelo	Unds.	Código	EAN	P.V.P (€)
100	PJ7000 3901	1	B-20644	0088381377133	26,00

Accesorios para 7104

Cadenas



Barra guía



Tipo	Medida (mm)	Modelo	Unds.	Código	EAN	P.V.P (€)
-	15	7104L	1	A-16564	0088381131612	392,00
-	16,5		1	A-16570	0088381131629	389,00
-	18,0		1	A-16586	0088381131636	411,00
-	21		1	A-16592	0088381131643	460,00
-	24,0		1	A-16601	0088381131650	528,00
Usar con piñón cod. 221502-5 y barra cod.122235-4.	30		1	A-16617	0088381131667	810,00

Cadena	Descripción Tipo / Uso	Unds.	Código	EAN	P.V.P (€)
30mm	Usar cuando se coloque cadena de 30mm.	1	122235-4	0088381122764	341,00

Piñón



Cadena	Descripción Tipo / Uso	Unds.	Código	EAN	P.V.P (€)
30 mm	Usar cuando se coloque cadena de 30mm.	1	221502-5	-	18,90

Aceite de cadena



Unds.	Código	EAN	P.V.P (€)
1	181434-7	0088381194747	1,35

Guía de ángulo



Modelo	Unds.	Código	EAN	P.V.P (€)
PJ7000 DPJ180 BPJ180	1	123149-0	0088381443173	21,00

Placa de ajuste



Modelos	Unds.	Código	EAN	P.V.P (€)
3901 PJ7000 DPJ180	1	415579-2	0088381155038	8,00

Llave de pivotes 20



Modelos	Unds.	Código	EAN	P.V.P (€)
3901 PJ7000 DPJ180 BPJ180	1	782401-1	0088381101240	0,95

Bolsa guarda polvo



Modelos	Unds.	Código	EAN	P.V.P (€)
3901	1	122474-6	0088381127547	7,60
PJ7000 DPJ180 BPJ180	1	123150-5	0088381403092	7,00

Casquillos cónicos



Modelo	Ø (mm)	Descripción	Unds.	Código	EAN	P.V.P (€)
3707FC	6	-	1	763607-0	0088381114806	2,80
	6,35 20,00	-	1	763608-8	0088381102292	3,30
3709 3710 4403	6	-	1	763662-2	0088381431606	4,10
	6,35 (1/4")	-	1	763663-0	0088381207294	4,40
RP1800 RP2300FC	1/2"	-	1	763622-4	0088381102315	16,50
	12	-	1	763628-2	0088381114813	16,50
	13	-	1	763632-1	0088381118538	26,00
3601B	12	-	1	763601-2	0088381123945	41,00
DRT50 RP0900 RT0700C RT0702C	6	-	1	763636-3	0088381142830	11,60
	6,35 (1/4")	-	1	763637-1	0088381102353	9,60
	8	-	1	763618-5	0088381114820	2,80
RP0910 RP110C	6	Con tuerca	1	193180-0	0088381156714	26,00
	8	Con tuerca	1	193178-7	0088381156721	22,00

Llaves



Reducción (mm)	Modelo	Unds.	Código	EAN	P.V.P (€)
8	RP0910 RP110C RP0900	1	781213-9	0088381102520	2,20
13	DRT50 RP0900 RT0702C RP0900	1	781006-4	0088381102407	1,95
17	3709 3710 3706 3707FC RP0910 RP110C 4403	1	781008-0	0088381102414	1,95
22	DRT50 RP0900 RT0700C RT0702C	1	781011-1	0088381102438	2,20
23	3601B	1	781012-9	0088381102445	2,30
24	RP1800 RP2300FC	1	781030-7	0088381151559	2,80



Casquillo reductor



Reducción (mm)	Modelo	Unds.	Código	EAN	P.V.P (€)
12 - 6 "	3601B RP1800 RP2300FC	1	763801-4	008838114646	3,30
12 - 8 "		1	763804-8	008838114653	3,30
12 - 10 "		1	763807-2	0088381124003	3,90
12 - 1/4 "		1	763803-0	0088381102360	3,30

Tuerca



Modelos	Unds.	Código	EAN	P.V.P (€)
3707FC 3709 3710 4403	1	763606-2	0088381123952	4,10
RP0900 RT0700C RT0702C	1	763615-1	0088381123969	3,30
RP0910 RP110C	1	763652-5	0088381170352	4,40
3612 3612C	1	763629-0	0088381123983	6,60
RP1800 RP2300FC	1	763674-5	-	7,20

Accesorios para 3706, DCO180 y DCO181



Guía circular



Modelos	Unds.	Código	EAN	P.V.P (€)
3706 DCO180 DCO181	1	193448-4	0088381163958	26,00

Colector de polvo



Modelos	Unds.	Código	EAN	P.V.P (€)
3706 DCO180 DCO181	1	193449-2	0088381160490	7,20

Casquillos cónicos



Medida (mm)	Modelo	Unds.	Código	EAN	P.V.P (€)
3,18	3706	1	324149-5	0088381161060	11,80
6,35 (1/4")		1	763608-8	0088381102292	3,30
3,18	DCO180 DCO181	1	763677-9	0088381468824	13,20
6,35 (1/4")		1	763676-1	0088381469012	16,00

Tuerca



Modelos	Unds.	Código	EAN	P.V.P (€)
3706	1	763606-2	0088381123952	4,10
DCO180 DCO181	1	763258-9	-	5,80

Guías de plantilla

1



1. Para modelos 3709, 3710, 3707FC, DRT50, RT0700C, RT0702C.

A (mm)	B (mm)	C (mm)	Modelos	Unds.	Código	EAN	P.V.P (€)
8,0	10,0	9,5	3709 3710 3707FC DRT50 RT0700C RT0702C	1	343577-5	0088381115681	0,80

2



2. Para modelos DRT50, RP0900, RP1800X, RP2300FCX, RT0700* Y RT0702C.

A (mm)	B (mm)	C (mm)	Modelos	Unds.	Código	EAN	P.V.P (€)
7,7	9,5	11,5	DRT50 RP0900 RP1800X RP2300FCX RT0700* RT0702C*	1	164379-4	0088381111676	14,90
9,0	11,0	13,0		1	164775-6	0088381111720	13,80
10,0	12,0	9,0		1	164388-3	0088381156356	12,70
11,0	12,7	13,0		1	164776-4	008838112062	14,30
14,5	16,0	13,0		1	344364-5	0088381141222	2,80
18,0	20,0	13,0		1	164393-0	0088381111683	17,10
24,0	27,0	13,0		1	164470-8	0088381111690	13,90
25,0	29,0	150,0		1	163080-8	0088381111645	11,60
27,0	30,0	13,0		1	164471-6	0088381111706	11,80
37,0	40,0	11,5		1	165046-4	0088381161237	17,10

* Con base de superficie

3



3. Para modelos RP0910, RP110C

A (mm)	B (mm)	C (mm)	Modelos	Unds.	Código	EAN	P.V.P (€)
9,0	11,0	11,5	RP0910 RP110C	1	193331-5	0088381159906	14,30
10,5	12,0	14,0		1	193332-3	0088381156615	10,20
14,5	16,0	11,5		1	193334-9	0088381159920	11,60
18,0	20,0	13,0		1	193335-7	0088381159937	17,30
22,0	14,0	13,0		1	193340-4	0088381159982	14,30
24,0	27,0	13,0		1	193336-5	0088381159944	13,20
27,0	30,0	13,0		1	193338-1	0088381159968	13,80
37,0	40,0	13,0		1	193339-9	0088381159975	15,40

Guía de plantilla completa

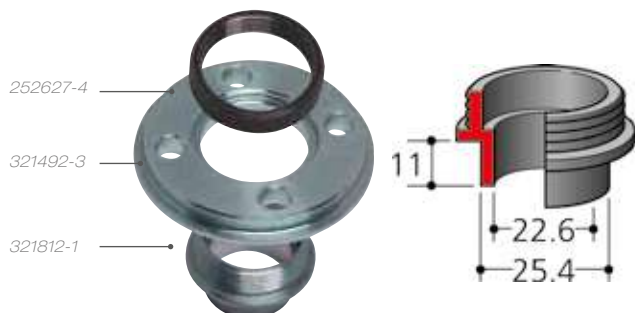

Modelo	Ø (mm)	Modelos	Unds.	Código	EAN	P.V.P (€)
Tuerca	M30	DRT50 RP0900 RP1800X RP2300FCX RT0700* RT0702C*	1	252627-4	0088381111782	11,00
Adaptador	-		1	321492-3	0088381111799	16,50
Casquillo	25,4mm		1	321812-1	0088381111805	10,80

* Con base de superficie

Guías de carril y accesorios



Pieza para unir dos carriles



Guía carril



Funda para carril guía

Descripción	Longitud (m)	Unds.	Código	EAN	P.V.P (€)
Pieza para unir dos carriles	-	1	198885-7	0088381497046	27,00
Guía carril	1	1	199140-0	0088381528672	48,00
	1,4	1	194368-5	0088381313353	76,00
	1,9	1	194925-9	0088381354790	117,00
	3	1	194367-7	0088381335201	198,00
Funda para carril guía	1	1	E-05670	0088381567183	49,00
	1,4	1	E-05664	0088381567176	57,00
	1,9	1	E-10920	0088381581523	89,00
	3	1	E-10936	0088381581530	110,00

Mordazas para carril guía



Descripción	Unds.	Código	EAN	P.V.P (€)
Set de sujeción para carril guía.	2	194385-5	0088381314084	30,00

Adaptador para guía de carril



Modelos	Unds.	Código	EAN	P.V.P (€)
RP0910 RP110C RP1800 RP2300FC RP0900 RT0700* RT0702C*	1	194579-2	0088381352611	39,00

* Con base de superficie



Accesorios para fresadora RT0700C multifunción y DRT50

Base recta

Placa para base



* Includa placa base

Descripción	Modelo	Unds.	Código	EAN	P.V.P (€)
Base	DRT50 RT0700C RT0702C	1	196613-4	0088381446136	28,00
Placa para base	RT001G	1	454842-8	-	2,65



Base para superficie

Placa para base



* Includa placa base

Descripción	Modelo	Unds.	Código	EAN	P.V.P (€)
Base	DRT50 RT0700C RT0702C	1	195563-0	0088381376099	75,00
Placa para base	RT001G	1	450819-1	-	3,40
Base de dos manos inmersión	RT001G	1	199201-6	0088381528641	83,00
Base de eje desplazada	RT001G	1	196093-4	0088381406482	89,00



Base inclinable 30° a 45°

Placa para base



* Includa placa base

Descripción	Modelo	Unds.	Código	EAN	P.V.P (€)
Base	DRT50 RT0700C RT0702C	1	198987-9	0088381525848	33,00
Placa para base	RT001G	1	413150-6	-	2,85
Base inclinable	RT001G	1	199202-4	-	35,00



Base eje desplazado

Placa para base



* Includa placa base

Descripción	Modelo	Unds.	Código	EAN	P.V.P (€)
Base	DRT50 RT0700C RT0702C	1	195562-2	0088381376082	88,00
Placa para base	RT001G	1	413148-3	3240890370846	5,05
Base de eje desplazada	RT001G	1	196093-4	0088381406482	89,00



Guías de recorte

1



2



3



Tipo	Modelo	Unds.	Código	EAN	P.V.P (€)
1	3709 3710 DRT50 RT0700C RT0702C	1	122703-7	0088381207300	3,70
2	RP1800X RP2300FCX	1	123022-4*	0088381115643	14,00
3	RP0900 RT0700C** RT0702C DRT50	1	STEX122385	0088381111164	39,00
	3601B	1	122343-1	0088381111621	27,00

* Necesario utilizar tope ajustable

** Con base de superficie

Bases



Base recta

Base inclinada

Tipo	Modelo	Unds.	Código	EAN	P.V.P (€)
Base recta	3707/F/FC	1	123544-4	-	30,00
Base inclinada		1	193904-4	0088381164726	49,00
Base recta con goma	3709 3710	1	194268-9	0088381248846	14,00
Base recta		1	194267-1	0088381248839	16,60
Base inclinada		1	194270-2	0088381248860	44,00

Tope ajustable



122700-3



195564-8

Modelos	Unds.	Código	EAN	P.V.P (€)
RP1800 RP2300FC	1	122700-3	0088381347327	18,70
DRT50 RT0700C RT0702C	1	195564-8	0088381411530	6,50

Para colocar guía de recorte.

Adaptadores de aspiración



Modelos	Unds.	Código	EAN	P.V.P (€)
3612 3612C	1	415412-8	0088381155014	5,40
RP1800X RP2300FCX	1	194934-8	0088381356756	11,60
DRT50* RP0900 RT0700C* RT0702C*	1	194733-8	0088381358972	2,40
DRT50 RT0700C RT0702C	1	195559-1	0088381411295	3,60

* Con base de superficie

Guías paralelas



Guía paralela con regulación milimétrica



195136-9

Modelos	Unds.	Código	EAN	P.V.P (€)
3707FC 3709 3710 DRT50 RT0700C RT0702C	1	122391-0	0088381115674	6,70
RP0900 RP0910 RP1100C	1	164834-6	0088381111737	4,50
3612C 3612	1	342428-9	0088381115667	7,30
DRT50* RP0900 RT0700* RT0702C* RP1100C RP1800 RP2300FCX	1	195136-9	0088381360623	57,00

Decapar



Accesorios para decapadores HG5030, HG6031V y HG6531C

Descripción		HG5030K	HG6031VK	HG6531VK	Unds.	Código	EAN	P.V.P (€)
		✓	✓	✓	1	PR00000029	0088381527934	8,20
		✓	✓	✓	1	PR00000028	0088381527927	8,20
		✓	✓	✓	1	PR00000030	0088381527941	10,50
		-	✓	✓	1	PR00000031	0088381527958	8,80
		-	-	✓	1	PR00000039	0088381528030	9,60
		-	-	✓	1	PR00000032	0088381527965	17,40
		-	-	✓	1	PR00000033	0088381527972	19,20
		-	-	✓	1	PR00000034	0088381527989	8,20
		✓	✓	✓	1	PR00000035	0088381527996	11,10
		✓	✓	✓	1	PR00000041	0088381528054	22,00

• **HG5030**



• **HG6031V**



• **HG6531C**



Tornillos y clavos



Atornilladores autoalimentados, clavadoras y grapadoras Makita



Ristra de tornillos para autoalimentados



Tornillo para tabiquería seca sobre guía metálica



Ø (mm)	Longitud (mm)	Tipo de rosca	Tratamiento	BFR440	BFR550	6842	6844	uds.	Código	EAN	P.V.P. (€)
3,5	25	Fina	Fosfatado	✓	✓	X	X	1.000	F-31227	0088381291781	16,30
3,5	35			✓	✓	X	X		F-31230	0088381291712	17,90
3,9	25			✓	✓	✓	X		F-30913	0088381291477	16,80
3,9	41			✓	✓	✓	X		F-31166	0088381291729	22,00

Tornillo para tabiquería seca sobre guía de madera



Ø (mm)	Longitud (mm)	Tipo de rosca	Tratamiento	BFR440	BFR550	6842	6844	uds.	Código	EAN	P.V.P. (€)
3,9	41	Gruesa	Fosfatado	✓	✓	✓	X	1.000	F-31182	0088381291743	28,00
3,9	55			X	X	✓	✓		F-31140	0088381291705	22,00

Tornillo anticorrosión



Ø (mm)	Longitud (mm)	Tipo de rosca	Tratamiento	BFR440	BFR550	6842	6844	uds.	Código	EAN	P.V.P. (€)
3,9	32	D/G	Anticorrosión	✓	✓	X	X	1.000	P-38283	0088381973991	31,00



Tornillos para atornillador autoalimentado - AR410HR

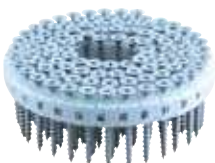

Ø caña (mm)	Ø cabeza (mm)	Longitud (mm)	Tipo	Rosca	Modelo	uds. / caja	Código	EAN	P.V.P. (€)
3,5	8,2	28	PH2	Fina	AR410HR	2.000	F-32843	0088381293402	37,00
3,5		41		Fina			F-32856	0088381293419	42,00
3,8		25		Grueso			F-32869	0088381293426	34,00
3,8		28		Grueso			F-32872	0088381293433	35,00
3,8		32		Grueso			F-32885	0088381293440	37,00
3,8		41		Grueso			F-32898	0088381293457	44,00



Clavos 0,6mm (23Ga) Inox - DPT351 y DPT353



Ø (mm)	Longitud (mm)	Tipo	Galga	Material	Modelos	uds. / caja	Código	EAN	P.V.P. (€)
0,6	18	Pin	23Ga	Inox	DPT351 DPT353	10.000	F-32142	0088381292702	27,00
	25						F-32155	0088381292719	31,00
	30						F-32168	0088381292726	35,00
	35						F-32171	0088381292733	40,00

Clavos 0,6mm (23Ga) Acero - DPT351 y DPT353



Ø (mm)	Longitud (mm)	Tipo	Galga	Material	Modelos	uds. / caja	Código	EAN	P.V.P. (€)
0,6	18	Pin	23Ga	Acero	DPT351 DPT353	10.000	F-31825	0088381292382	14,30
	25						F-31838	0088381292399	15,40
	30						F-31841	0088381292405	17,30
	35						F-31854	0088381292412	19,30

Clavos 1,2mm (18Ga) - AF505N, DBN500 y DFN350



Ø (mm)	Longitud (mm)	Tipo	Galga	Modelos	uds. / caja	Código	EAN	P.V.P. (€)
1,2	20	Brad	18Ga	AF505N DBN500 DFN350*	5.000	P-45923	0088381976367	12,40
	25					P-45939	0088381976374	14,10
	30					P-45945	0088381976381	16,50
	40					P-45951	0088381976398	17,70
	50					P-45967	0088381976404	21,00

*Solo hasta clavo de 30mm

Clavos multimaterial - AN250HC

- El clavo de hormigón tiene una guía (casquillo de plástico) que impide la inclinación del clavo y permite un disparo recto, clavos de 19 a 25 mm y sin inclinación.
- Recomendaciones: No clavar directamente sobre el hormigón, colocar el clavo a 10 cm del extremo del hormigón, colocar los clavos a 10 cm de distancia como mínimo.

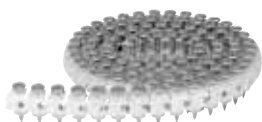

Ø caña (mm)	Ø cabeza (mm)	Longitud (mm)	Tipo	Modelos	uds. / caja	Código	EAN	P.V.P. (€)
2,5		22				F-33575	0088381294133	57,00
2,5		25				F-33588	0088381294140	59,00
3		19				F-33591	0088381294157	90,00

Clavos multimaterial. Cada caja contiene un bote de gas. - GN420C



Ø (mm)	Longitud (mm)	Calidad	Tipo	uds. GAS	Modelos	uds. / caja	Código	EAN	P.V.P. (€)
3,1	15	Premium	Para todo tipo de materiales	1	GN420C	1.000	196285-5	0088381422932	88,00
	17						196286-3	0088381422949	88,00
	22						196287-1	0088381422956	88,00
	27						196288-9	0088381422963	88,00
	32						196289-7	0088381422970	88,00



Ø (mm)	Longitud (mm)	Calidad	Tipo	uds. GAS	Modelos	uds. / caja	Código	EAN	P.V.P. (€)
2,6	20	Estándar	Para todo tipo de materiales excepto hormigón	1	GN420C	1.000	196290-2	0088381422987	81,00
	25						196291-0	0088381422994	81,00
	30						196292-8	0088381423007	81,00
	35						196293-6	0088381423014	81,00
	40						196294-4	0088381423021	81,00

Cargador de clavos - GN420C



Modelos	uds. / caja	uds. por carga	Código	EAN	P.V.P. (€)
GN420C	1	20	196246-5	0088381417891	215,00

Grapas

Grapas de 90 - AT638



Ancho grapa (mm)	Longitud (mm)	Tipo	Modelos	uds. / caja	Código	EAN	P.V.P. (€)
1/4"	15	18Ga	AT638	5.000	P-45864	0088381976305	15,90
	18				P-45870	0088381976312	17,10
	25				P-45886	0088381976329	21,00
	30				P-45892	0088381976336	25,00
	35				P-45901	0088381976343	27,00
	38				P-45917	0088381976350	30,00

Grapas para máquinas a batería



Ancho grapa (mm)	Longitud (mm)	Modelos	uds. caja	Código	EAN	P.V.P. (€)
------------------	---------------	---------	-----------	--------	-----	------------

DST221

10	10	DST221	5.000	F-32647	0088381293204	14,90
	13			F-32650	0088381293211	13,20
	16			F-32663	0088381293228	17,70
	19			F-32676	0088381293235	20,00
	22			F-32689	0088381293242	21,00

ST113D y DST112

10	7	ST113D DST112	25.000	F-81518	0088381342308	25,00
	10		15.000	F-81521	0088381342322	19,30

Protector de punta DPT350



Descripción	uds.	Código	EAN	P.V.P. (€)
Evita marcar la madera durante el clavado.	1	419525-7	0088381341097	1,55

Bote de aceite



Contenido	Modelos	uds.	Código	EAN	P.V.P. (€)
30 ml	Todos	1	181434-7	0088381194747	1,35



VARIOS

Bote de gas



Modelos	uds.	Código	EAN	P.V.P. (€)
GN900 GN420C	1	242094-1	0088381415712	17,70

Bote de gas



Modelo	uds.	Código	EAN	P.V.P. (€)
GF600	1	242088-6	0088381401968	15,40

Gafas de seguridad



Modelos	uds.	Código	EAN	P.V.P. (€)
Todos	1	195246-2	0088381365413	4,70

Accesorios para alta presión

Mangueras - AC310H



B-80014

Contenido	Modelo	uds.	Código	EAN	P.V.P. (€)
Manguera 30m	AC310H	1	B-80020	0088381350761	316,00
Manguera 15m		1	B-80014	0088381350754	215,00
Manguera 7,5m		1	B-80036	0088381350778	175,00

Aceite lubricante



Modelos	uds.	Código	EAN	P.V.P. (€)
GN900 GN420C	1	242077-1	0088381351973	11,60

Limpiador



Modelos	uds.	Código	EAN	P.V.P. (€)
GN900 GN420C	1	242075-5	0088381351966	21,00

Kit limpiador



Modelos	uds.	Código	EAN	P.V.P. (€)
GN900 GN420C GF600	1	194852-0	0088381351959	48,00

Carro de transporte - AC310H



Contenido	Modelo	uds.	Código	EAN	P.V.P. (€)
Carro de transporte	AC310H	1	HY00000212	0088381351188	207,00

Aspiración



HEPA
filtro



Amplia gama de aspiradores a batería. Potentes - Ligeros - Manejables.



LXT
Lithio-ion EXTREMA TECNOLOGIA

XGT

CXT



18V
LITHIO-ION

BL
MOTOR

CXT

HEPA
filtro

18V X2
36V

AWS

Para más información consulta el catálogo de herramientas.



Mecanismo de limpieza de la bolsa de papel para polvo eficiencia laboral (solo DVC660 / DVC665)

Incluso al aspirar polvo de hormigón, este tiende a obstruir los filtros. La activación de este mecanismo permite recoger aproximadamente hasta 4,0L, el 70% de la capacidad de la bolsa de papel para polvo. (aproximadamente 3,0 L [50%] cuando no se activa

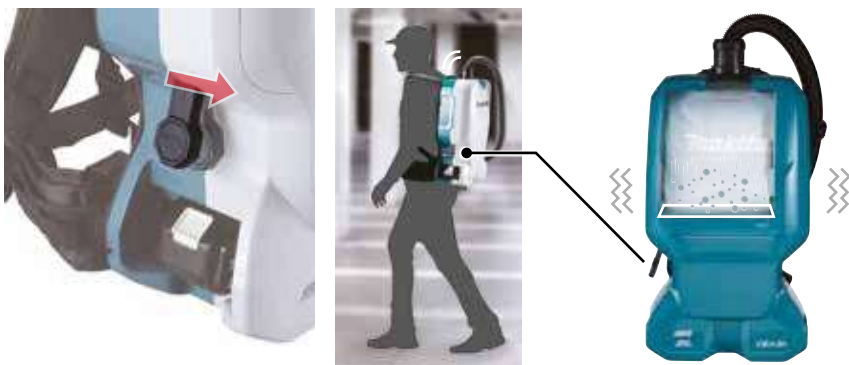

Este mecanismo se puede accionar:

- Automáticamente por la vibración provocada al caminar.
- Manualmente accionando una palanca que está situada en el lateral.

Mando controlador

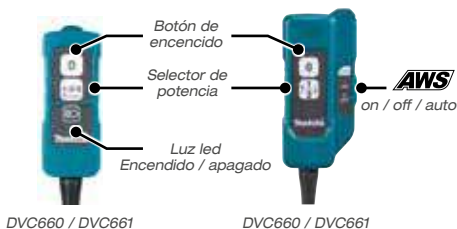

Tecnología de conexión inalámbrica



• La función de activación inalámbrica automática permite un funcionamiento limpio y cómodo. Al conectar una herramienta compatible al aspirador, puede accionar el aspirador junto con el arranque de la herramienta.



• AWS se conecta a la herramienta eléctrica mediante Bluetooth.

- La marca denominativa y los logotipos de Bluetooth® son marcas comerciales registradas propiedad de Bluetooth SIG, Inc. y cualquier uso de dichas marcas por parte de Makita se realiza bajo licencia. Otras marcas comerciales y nombres comerciales pertenecen a sus respectivos propietarios.

El aire que sale es tan limpio como el del filtro de aire.

El filtro HEPA se utiliza como filtro principal para capturar partículas muy finas con eficacia.



El sistema eficiente de filtración HEPA de tres etapas captura el 99,97 % de partículas de 3 micras o más grandes.

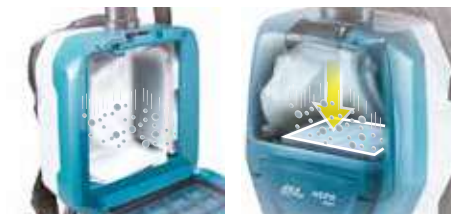

DVC660 / DVC665

DVC261 / DVC265



Accesorios para aspiradores

Boquilla 28mm

Boquilla 38mm

Boquilla 32mm

Para recolección de polvo *Solo para modelos DVC261, DVC265, DVC660, DVC665

Modelo VC006GM VC007GL	Modelo VC004GL DVC157L	Modelo DVC265 DVC665 DVC350	Modelo DVC750L	Modelo VC4210L/M VC3012L	Modelo VC2012L VC2512L VC3011L
-------------------------------------	-------------------------------------	---	--------------------------	---------------------------------------	--

Tubo flexible 28mm
1,0m *143787-2 sin adaptador
1,5m A-34235 con adaptador de 22, 38mm
2,5m 195437-5 con adaptador de 22, 24, 38mm
3,5m 195433-3 con adaptador de 22, 24, 38mm
5,0m 195436-7 con adaptador de 22, 24, 38mm

Tubo flexible 38mm
Con adaptador de 38mm
1,5 M 198757-6
2,5 M 195434-1
5,0 M 195435-9

Tubo flexible 32mm
4m P-84084

Tubo flexible 32mm
3,5m P-81739

Adaptadores
Adaptador 38mm
195545-2
Adaptador 22mm
195547-8

Adaptadores
Adaptador 24mm
195546-0

Adaptador
Adaptador de manguera 22-38mm
195548-6

Adaptador
Adaptador 24mm
195546-0

Adaptador
Adaptador de manguera Set 24mm P-70378
Set 38mm W107418688

Adaptador
22mm W107418661
Adaptador 38mm W107418680



AWS
Sistema de arranque inalámbrico

Dispositivo AWS

WUT02
Adaptador que convierte los aspiradores activados por gatillo en aspiradores inalámbricos compatibles con AWS

199773-1

Adaptadores y tubos flexibles

Tubo flexible 28mm
Proporcionado con adaptadores para 22 y 38mm

Boquilla trasera

Adaptador: 38mm
Ø interior: 38mm
Ø exterior: 44,2mm

Adaptador: 22mm
Ø interior: 22,4mm
Ø exterior: 25mm

Tubo flexible 38mm
Proporcionado con adaptadores para 38mm

Boquilla trasera

Adaptador: 38mm
Ø interior: 38mm
Ø exterior: 44,2mm

Adaptadores 38, 22 y 24mm

Boquilla de 28mm con adaptador de 22mm

Boquilla de 28mm con adaptador de 38mm

Boquilla de 38mm con adaptador de 38mm

Boquilla de 24mm

Conexión entre tubos

Boquilla de 28mm con adaptador de 38mm

Boquilla de 28mm

Boquilla 38mm con adaptador de 38mm

Boquilla de 38mm

Boquillas traseras

Adaptador de manguera 22-38

Boquilla de 38mm

Tamaño
Ø interior: 22,4mm
Ø exterior: 25mm

Adaptador de manguera 22-38

Accesorios para aspiradores

A



Con boquilla de 28mm

Modelo DVC157L
VC004GL DVC660 / DVC665
VC008G DVC261 / DVC265

Con adaptador
38mm 24mm 22mm



B



Con boquilla de 38mm

Modelo
VC003GL
VC005GL / DVC155L
DVC860L
DVC750L

Con adaptador 22-38



C



Con boquilla de 32mm

Modelo
VC2012L / VC2512L
VC3011L

Con adaptador 24mm **Adaptador 38mm (opcional)**



P-81745 P-70421

D



Con boquilla de 32mm

Modelo
VC3012L

Con adaptador 24mm **Con adaptador 38mm**



P-70378 W107418688



A B
Adaptadores de 24 o 38mm



C D
Adaptador de 24mm



A B
Adaptador de 22mm



C D
Adaptador de 24mm



*Base de agarre para la copa de aspiración necesaria

	Modelo	Modo	Acc. de aspiración		Adaptador
			Tipo	Código	
Martillo demoledor	HM1501, HM1511, HM1512	---	Con boquilla	191M20-4	Adaptadores de 24 o 38mm
	HM1307C, HM1317C/CB, HM1812	---	Sin boquilla	197168-2	Boquilla de 28mm sin adaptador
	HM001G, HM002G, HM0830, HM0870C, HM0871C, HM1101C, HM1111C, HM1203C, HM1205C, HM1213C, HM1214C	---	Sin boquilla	199143-4	Boquilla de 28mm sin adaptador
Martillo combinado	HR5212C, HR5202C	Percusión / demolición	---	196858-4	Adaptadores de 22mm
	HR4002, HR4501C, HR4511C	Percusión / demolición	---	196074-8	Boquilla de 28mm sin adaptador
	HR5212C, HR5202C, HR4002, HR4501C, HR4511C, HR4041C, HR4013C, HR4003C, DHR400, HR005G, HR006G	Demolición	---	199143-4	Boquilla de 28mm sin adaptador

	Modelo	Modo	Acc. de aspiración		Adaptador
			Tipo	Código	
Martillo combinado	HR140D, HR166D, DHR165, DHR171, DHR182, DHR202, DHR263, DHR264, HR2230, HR2470, HR2470F, HR2470FT, HR2800, HR2810, HR2810T, HR2811FT	Percusión	Kit de recolección de polvo	193472-7	Adaptador de 22mm
	*DHR165, *DHR171, *DHR182, *DHR202, DHR263, *HR1841F, *HR2230, HR2470, HR2470F, HR2800, HR2810	Todos	Copa de recolección de polvo	198362-9	Adaptador de 22mm
	DHR242, DHR280, DHR282, HR001G, HR003G, HR2300, HR2600, HR2630, HR2631F, HR2641, HR2651, HR2652, HR2653, HR3011F, HR007G	Todos	Copa de recolección de polvo	195173-3	Adaptador de 22mm
	DHR243, DHR281, DHR283, HR002G, HR2630T, HR2631FT, HR2653T, HR3012F	Todos	Copa de recolección de polvo	195179-1	Adaptador de 22mm



Accesorios para aspiradores

Sierras circulares

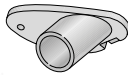

A B

Adaptadores de 22 o 38mm



C D

Adaptador de 24mm



+
Conexión 25-50mm
192349-3



o
Adaptador de 24mm*



*Sin necesidad
otro adaptador



Modelo	Set de boquillas y conexiones		Adaptador
	Descripción	Código	
HS012G, DHS680	Set de boquillas	196961-1	Adaptador de 24mm
DHS710	Set de boquillas	196520-1	Adaptador de 24mm
DHS782, DHS783	Set de boquillas	196520-1	Adaptador de 24mm
HS009G, HS011G	---	---	Adaptador de 24mm
DHS900, DHS901, DSP600, DSP601	---	---	Adaptador de 24mm
RS001G	---	---	Adaptador de 24mm
RS002G	---	---	Adaptador de 38mm
5103R	Conexión y set de conexiones sin necesidad de tornillo	456914-5 / 192419-8	Adaptador de 38mm
5903R	Set de conexiones	192419-8	Adaptador de 38mm
HS004G	Set de boquillas	196520-1	Adaptador de 24mm
HS6601	Set de boquillas	196520-1	Adaptador de 24mm
HS7010	Set de boquillas	196520-1	Adaptador de 24mm
HS7601, HS7611	Set de boquillas	196520-1	Adaptador de 24mm
SP6000, SP001G	---	---	Adaptador de 24mm

Coletores de polvo para amoladoras



A B

Adaptadores de 22 o 38mm



C D

Adaptador de 24mm



Modelo	Set colectores de polvo		Adaptador
	Tipo de protector	Código	
Modelos de triple muesca 125mm	C	196845-3	Adaptador de 38mm
Modelos de cambio sin accesorios (palanca) 125mm	C	191G06-2	Adaptador de 38mm
Modelos de triple muesca sin freno 230mm	D	198440-5	Adaptador de 38mm
Modelos de una y dos muescas 230mm	B	198440-5	Adaptador de 38mm
Modelos de una muesca 230mm	B	198440-5	Adaptador de 38mm



Coletores de polvo de discos de diamante



Modelo	Set de colector de polvo para discos de diamante		Adaptador
	Tamaño	Código	
Modelos de triple muesca 180mm / 230mm	180mm	195385-8	Adaptador de 38mm
115-125mm	125mm	195239-9	Adaptador de 38mm
X-Lock 115-125mm	125mm	191F81-2	Adaptador de 38mm































Accesorios para aspiradores

Modelo + accesorio		Aspirador + accesorio	
Lijadora de banda DBS180, 9032	Boquilla de aspiración 122652-8		
Lijadora de banda 9031			
Lijadora orbital DB0380, DB0381, DB0382, DB0480, DB0481, DB0482, DB0484, 9046, B03711, B04900/V, B04901 B04556, B04565, B04566		A Adaptador de 22mm	
Lijadora rotorbita B05030, B05031, B05040, B05041, B06030, B06040, DB0180		B Con adaptador 22-38mm 195548-6	
Multiherramienta DTM52 DTM51 TM3000C TM3010C	Set de aspiración 191R02-6 199627-2 199618-3 199624-8	C Adaptador de 24mm + Conexión 25-50mm 192349-3 o Adaptador de 24mm*	C Adaptador de 24mm + Conexión 25-50mm 192349-3 o Adaptador de 24mm*
Lijadora de banda 9404, 9903, 9910, 9911, 9920		D Adaptador de 38mm + Conexión 22+38mm 195548-6 o Adaptador de 24mm*	D Adaptador de 38mm + Conexión 22+38mm 195548-6 o Adaptador de 24mm*
Lijadora rotorbita B06050J	Adaptador 24mm 195546-0		
Lijadora de pared DSL801	Adaptador 24mm 195546-0		
		*sin necesidad de otro adaptador	

Modelo + accesorio		Aspirador + accesorio	
Sierra de calar JV183D, 4326, 4327, 4328, 4329 JV0600		A Adaptador de 22mm	
Sierra de calar DJV180, 4350T/CT/FCT, 4351CT	Adaptador de aspiración 417853-4	B Con adaptador 22-38mm 195548-6	
Sierra de calar DJV181, DJV182 JV102D, JV103D	Set de aspiración 126331-0 457801-1	C Adaptador de 24mm + Conexión 25-50mm 192349-3 o Adaptador de 24mm*	C Adaptador de 24mm + Conexión 25-50mm 192349-3 o Adaptador de 24mm*
	Adaptador 24mm 195546-0	D Adaptador de 38mm + Conexión 22+38mm 195548-6 o Adaptador de 24mm*	D Adaptador de 38mm + Conexión 22+38mm 195548-6 o Adaptador de 24mm*
		*sin necesidad de otro adaptador	

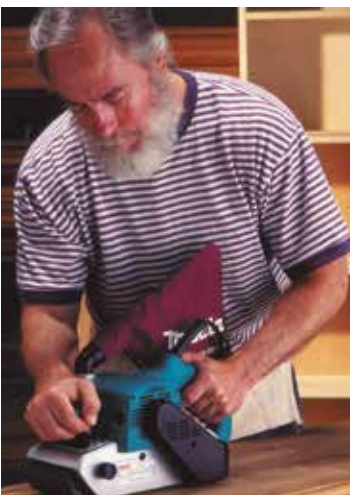

Accesorios para aspiradores

Modelo + accesorio	Aspirador + accesorio	Modelo + accesorio	Aspirador + accesorio
Cortador de diamante 4114S 	Adaptador acordado 192613-2 	Ingletadora telescópica DLS714 	
Cortador de diamante 4100KB 		Ingletadora telescópica LS0714/F/FL LS0815FL, LS1018/L 	
Cortador de diamante DCC500 		Ingletadora LS1030N, LS1440 	
Rozadora SG1251J 		Ingletadora LS1040/F 	A Adaptador de 38mm 
Desbastadora de diamante PC5001C, PC5010C 		Ingletadora DLS600Z 	B  C Adaptador de 38mm 
Lijadora de banda 9924DB 	Adaptador 32mm 192518-6 	Sierra reversible LF1000 	D Adaptador de manguera 38mm 
Lijadora de banda 9403 	Adaptador 24mm 195546-0 	Ingletadora con sierra de mesa LH1040/F, LH1201FL 	A Adaptador de 38mm* 
Lijadora de cepillo N9741 	Adaptador 410899-9 	Ingletadora telescópica LS1019/L, LS1219/L 	B  C Adaptador de 38mm 
		Ingletadora telescópica LS002G, LS003G, LS004G, DLS111, DLS211 	D Adaptador de manguera 38mm 

* Excepto modelos:
VC008G / DVC660 /
DVC665 / DVC261 /
DVC265



Accesorios para aspiradores

Modelo + accesorio

Aspirador + accesorio

Sierra de mesa
MLT100N



Adaptador de aspiración
JM27000090



A Adaptador de 38mm*



* Excepto modelos:
VC008G / DVC660 /
DVC665 / DVC261 /
DVC265

Sierra de mesa
2712



B



C Adaptador de 38mm



Cepillo de regreso
2012NB



Adaptador de aspiración
193036-7



D Adaptador de manguera 38mm



Sólo válido para toma industrial.
Diámetro exterior:
75 mm

Modelo + accesorio

Aspirador + accesorio

Cepillo

KP001G, DKP181,
KP0810/C



A Adaptador de 38mm*



* DV350: No puede ser usado con cepillos

Cepillo

DKP180, KP0800

Boquilla

451329-1



C Adaptador de 38mm



Cepillo

1100



Recojevirutas

415452-6



D Adaptador de manguera 38mm



Cepillo

KP0800, KP312/S



Adaptador de boquillas



Conexión

*Codo



Modelo	Código
1923B	152464-5
KP0800, DKP180	451329-1
KP312/S	193733-5

Modelo	Código
DKP180, DKP181, KP0810/ C, KP0800	*191C20-4
1804N, 1805N, 1806B, KP312/S	181575-9



Accesorios para aspiradores

Modelo + accesorio

Aspirador + accesorio

Modelo + accesorio

Aspirador + accesorio

Engalletadora
PJ7000, DPJ180



Fresadora de corte 3706 **Colector de polvo** 193449-2



Fresadora de corte
DC0181, DC0180



Cortador de tabiquería seca
DSD180, SD100D



Fresadora
RP1111C, RP1110C,
RP0910



A Adaptador de 22mm



*DVC350
No puede usarse
con fresadoras

B Con adaptador 22-38mm



195548-6

C Adaptador de 24mm



+
Conexión 25-50mm
192349-3

D Adaptador de 38mm



+
Conexión 22+38mm
195548-6

Fresadoras
RP1802/F, RP1801F,
RP1800/F, RP2303FC,
RP2300FC



3612BR

Boquilla de aspiración
194934-8



192035-6

Fresadoras
RP0900, RT0700C,
RT0702C



Boquilla de aspiración
194733-8



Fresadoras
RT001G, DRT50

Fresadoras multifunción
RT0700C,
RT001G,
DRT50



Adaptador de aspiración
195559-1



A Adaptador de 38mm



B



C Adaptador de 38mm



D Adaptador de manguera 38mm



Accesorios para aspiradores

con boquilla Accesorios de 28mm

Para limpieza *Solo para modelos DVC261, DVC265, DVC660, DVC665

Modelo VC006GM VC005GL VC007GL DVC155L VC003GL DVC860L		Modelo DVC261 DVC660	
--	--	-----------------------------------	--

Tubo flexible 38mm Con boquilla 32A 1,5m 199388-4		Tubo flexible 32mm Con boquilla 32A 1,5m 199463-9 1,7m 199493-7		Tubo flexible 28mm 1,0m *143787-2 1,5m 152992-0 2,5m 195437-5 3,5m 195433-3 5,0m 195436-7	
--	--	---	--	---	--

Tubo curvo con cierre 28mm Con boquilla 32A 140G26-3		Tubo curvo con cierre 28mm + jack 127093-3		Tubo curvo con cierre 28mm + jack 458184-2		Tubo curvo sin cierre 28mm + jack 126756-8		Adaptador de 22mm 126756-8	
---	--	--	--	--	--	--	--	--------------------------------------	--

Accesorio ciclónico con cierre 191D71-3 ○		Accesorio ciclónico sin cierre 199491-1	
Tubo telescópico con cierre 28mm aluminio 590-942mm 140G19-0		Tubo telescópico sin cierre 28mm plástico 500-850mm 198560-5	
Tubo telescópico con cierre 28mm plástico 590-950mm 127605-2		Tubo recto sin cierre 28mm plástico 465mm 451424-7 ● 451241-5 ○ 451244-9 ● 456587-4 ●	Tubo recto sin cierre 28mm plástico 320mm 191D79-7 ○
Tubo recto con cierre 28mm plástico 479mm 459353-8 ○ 459356-2 ●		Tubo recto con cierre 28mm plástico 340mm 191D76-3 ○	
Boquilla extralarga 192236-6* * usar con J22 195547-8			

Pie de aspiración Plano 199454-7 ●		Pie de aspiración Universal 123488-8 ● 123539-7 ●		Pie de aspiración Alfombra 198149-9 ● 198527-3 ● 198529-9 ●		Pie de aspiración Alfombra 122291-4 ●	
Cepillo Automóvil asiento largo 199041-2 ●		Cepillo Automóvil alfombra 459056-4 ●		Cepillo Automóvil asiento corto 140H95-0 ●		Cepillo recto 191M30-1 ●	
Ranuras corto 416041-0 ● 413859-0 ● 456586-6 ●		Ranuras largo 198990-0 ● 198992-6 ●		Ranuras largo 199439-3 ○		Cepillo redondo 198552-4 ● 198553-2 ● 198555-8 ●	
Cepillo recto para salpicadero giratorio 140H94-2 ●		Boquilla de goma para ranuras 422437-5		Boquilla flexible 197901-2		Estas boquillas no pueden ser conectadas directamente a tubos rectos o telescópicos.	



Accesorios para aspiradores

Accesorio 38mm

Conexion 32mm

Accesorio 28mm

Modelo
VC003GL
VC005GL
DVC155L
DVC860L



Modelo
VC008G
DVC261
DVC660
DVC350



Set completo

Tubo flexible 38mm x 2,5m
Tubo recto y curvo
Pie de aspiración
Boquilla de ranuras
195439-1



Tubo flexible 38mm

1,5 198757-6
2,5 195434-1
5,0 195435-9



Tubo curvo

192562-3

Tubo recto

192563-1



Pie de aspiración

Plano / Seco
199454-7



Pie de aspiración

Universal
195551-7



Pie de aspiración

Ancho húmedo
A-47846



Pie de aspiración

Suelo y alfombra / Seco
198533-8



Pie de aspiración

Compact tipo A Seco
122335-2



Cepillo redondo

191657-9



Pie de aspiración

Compact tipo B húmedo
122335-0



Boquilla ranuras

410306-2



Modelo
VC4210L
VC4210M



Modelo
VC2012L
VC2512L
VC3011L



Modelo
DCL184, CL121D



Tubo flexible 32mm

4m P-84084



Tubo flexible 32mm

3,5m P-81739



Tubo curvo inox.

P-70346



Tubos rectos

35 x 500mm

(2 unds)

P-70437



Tubos rectos

35 x 350mm

(3 unds)

W107418350



Pie seco / húmedo

36 x 300mm

P-81789



Boca para ranuras

5 x 300mm

W6084



Tubo curvo

P-72908



Tubos rectos

35 x 520mm

(2 unds)

P-72942



Pie seco / húmedo

36 x 260mm

W107402706



28 mm



Boquilla flexible

197901-2



Boquilla de soplado para coche completa

140J64-3



Filtro y bolsa de polvo



Para polvo (partículas)

Filtro para partículas

Set de amortiguación

Pre-filtro

Bolsa de recogida de polvo (plástico o tela)

Para húmedo y seco

Filtro de tela o filtro para agua

Compatible con bolsas de plástico y tela de uso común, consiguiendo:

- Fácil extracción del polvo y vaciado
- Coste reducido y durabilidad aumentada comparado a las bolsas de papel



	VC006GM, VC007GL (húmedo y seco)	VC003GL (húmedo y seco)	VC004GL, VC005GL (seco)	DVC155L, DVC860L (húmedo y seco)	
Usados como un set	Set de filtro para partículas de polvo Sólo para seco. *Filtro HEPA para uso en seco.	1911B6-0 *1911B7-8 	*191V70-3 	*191V70-3 	*1917166-6
	Set de amortiguación	1911B4-4 	191V68-0 	191V68-0 	195552-5
	Set de pre-filtro	1911B5-2 	191V69-8 	191V69-8 	195553-3
Filtro de tela Para húmedo y seco.		144625-1 	144625-1 191V71-1 *sólo para VC005G 	140248-3 	
Filtro para agua Para húmedo. Se recomienda usar este filtro cuando se va a recoger grandes cantidades de agua repetidamente.	1910N0-0 	191V67-2 			
Set de bolsas de filtro nylon 10L/15L/25L/35L (5 ud.) Para seco.	35L: 1910Y4-9 	10L: 1912R3-4 VC005GL, DVC860 15L: 195557-5 VC003GL, VC004GL, DVC155L, DVC157L 			
Set de bolsas de filtro plástico (10 ud.)	1910R3-2 	195432-5 	195432-5 	195432-5 	

Para usar un filtro de polvo, retire el flotador y su caja quitando las pestañas laterales.

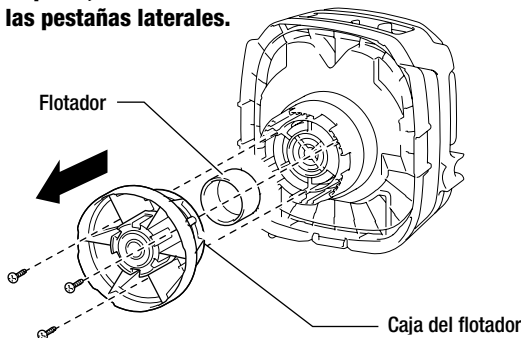

Accesorios para aspiradores de mano

Modelos con cierre:

- CL001G ●
- CL002G ●
- CL003G ●
- DCL284F ●
- DCL286F ●

- DCL281F ● ● ●
- CL117FD ● ●



Modelos sin cierre:

- DCL180 ● ●
- CL106D ● ●
- CL108FD ● ●
- CL100D ● ●



Accesorio ciclónico con cierre

191D71-3 ○



Accesorio ciclónico con cierre

1910D5-0* ●

* Sólo para modelos CL001G, CL003G, DCL284F, DCL286F, DCL180



Accesorio ciclónico sin cierre

199491-1*



* Sensor incluido

Manguera flexible

191E30-3



Tubo recto con cierre

Tubo recto 28L telescópico de plástico con cierre

479-719mm
Compatible con: CL001G, CL002G, CL003G, DCL284F, DCL286F, DCL281F, 1910Y3-1 ○



Tubo recto 28L de plástico con cierre

479mm
459353-8 ○
459356-2 ●



Tubo recto 28L de plástico con cierre

340mm
Para accesorios ciclónicos 191D76-3 ○



Tubo telescópico sin cierre 28mm plástico 500-850mm

198560-5



Tubo recto sin cierre 28mm plástico 465mm

451424-7 ●
451241-5 ○
451244-9 ●
456587-4 ●

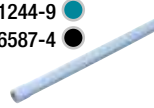

Tubo recto sin cierre 28mm plástico 320mm

191D79-7 ○



Tubo flexible

198544-3 ○
198545-1 ●
198547-7 ●



Accesorios de 28mm

Pie de aspiración Plano

199454-7 ●



Pie de aspiración Universal

123488-8 ●
123539-7 ●



Pie de aspiración Alfombra

198149-9 ●
198527-3 ●
198529-9 ●



Ranuras corto

416041-0 ●
413859-0 ●
456586-6 ●



Ranuras largo

198990-0 ●
198992-6 ●



Ranuras extra-largo

199439-3 ○



Pie de aspiración Alfombra

122291-4 ●



Cepillo Automóvil asiento largo

199041-2 ●



Cepillo Automóvil alfombra

459056-4 ●



Cepillo Automóvil asiento corto

140H95-0 ●



Cepillo recto

191M30-1 ●



Boquilla de goma para ranuras

422437-5



Esta boquilla no pueden ser conectada directamente a tubos rectos o telescópicos.

Cepillo redondo

198552-4 ●
198553-2 ●
198555-8 ●



Cepillo recto

198537-0 ●
198538-8 ●
198540-1 ●



Cepillo para salpicadero giratorio

140H94-2 ●



Soporte de pared

Compatible con:
CL001G, CL002G, DCL284F, DCL281F
DCL180, DCL180F
199971-7

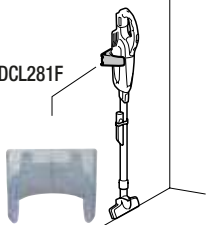

Accesorios para aspiradores de mano

Aspirador de tipo cápsula Modelos: CL001G, DCL284F, DCL281F, DCL180F, CL108FD, CL106FD, CL070D

Filtro HEPA
199989-8
HEPA filter
Excepto modelo: CL183D

Filtro HEPA + Pre-filtro

Filtro HEPA + Filtro de polvo

Pre-filtro
198751-8

Estructura del filtro
458467-0

Filtro (10 ud)
198915-4

Filtro de polvo (de alta eficiencia)
199966-0

Filtro de polvo

Válvula
424208-6

Esponja 57
422268-2
Excepto modelo: CL070D, CL183D



Aspirador de bolsa de papel Modelos: CL001G, DCL284F, DCL281F, DCL180F, CL108FD, CL106FD, CL070D

Aspiradores de mano

Esponja 76-110
424804-0

Estructura
413J77-0
Sólo para CL002G

Bolsa de papel (10 ud)
(de alta eficiencia)
194566-1

Válvula anti-polvo
143677-9
Para DCL184, CL121D

Bolsa para polvo
198747-9

DCL184, CL121D

140K23-3
CL002G

Bolsa para polvo fácil de vaciar
198749-5
Sólo para CL002G

Esponja 90
422440-6

Bolsa para polvo alta eficiencia
1910M4-5
Sólo para CL002G

Nuevo accesorio ciclónico Modelos: CL001G, CL003G, DCL284F, DCL286F, DCL180

Accesorio ciclónico con cierre
1910D5-0*

Esponja 62
(equipo básico)
422909-0

Filtro HEPA
1910C9-5
HEPA filter

Filtro de alta eficiencia
(equipo básico)
1910C7-9

Esponja de filtro
(equipo básico)
422908-2



Accesorios para aspirador de pie y portátil

Color

Aspirador vertical Modelo: DVC560

Accesorios de 28mm

Cepillo

Automóvil asiento largo
199041-2 ●



Ranuras largo

198990-0 ●
198992-6 ●

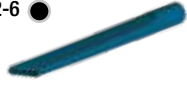

Cepillo

Automóvil alfombra
459056-4 ●



Ranuras extra-largo

199439-3 ○



Cepillo

Automóvil asiento corto
140H95-0 ●



Cepillo redondo

198552-4 ●
198553-2 ●
198555-8 ●



Cepillo recto

191M30-1 ●



Cepillo recto

198537-0 ●
198538-8 ●
198540-1 ●



Cepillo para salpicadero giratorio

140H94-2 ●



Set de bolsas (10 ud)
191T96-3



Filtro HEPA **HEPA**
191E39-5 **filter**



Set completo de cepillos

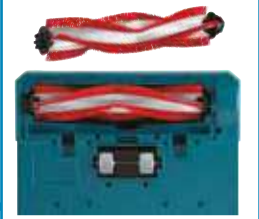

Aspirador/Soplador portátil Modelo: DVC750

Tubo flexible para limpieza

28-2.0m con adaptador de 38mm
140G04-3



Para seco

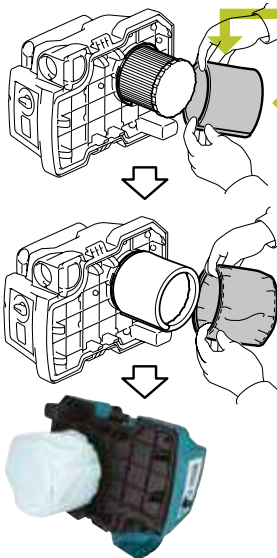

Filtro HEPA

Para seco 162518-0



Filtro de esponja

422449-8



Pre-Filtro

162635-6



Accesorios de 38mm

Boquilla ancha

458891-7



Cepillo redondo

191657-9



Adaptador 38mm

418500-0



Boquilla corta

458919-1



Boquilla ranuras

410306-2



Adaptador 22-38mm

195548-6

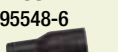

Boquilla extralarga

192236-6*



Accesorios de 28mm



Sujección para el hombro

199486-4



Accesorios para aspiradores de mochila y robots aspiradores

Aspiradores de mochila Modelos: VC008G, DVC660, DVC665, DVC261, DVC265

DVC660, DVC665



Bolsa reutilizable
191C30-1

Set de bolsas de nylon con filtro
(10 ud)
191C26-2

Filtro HEPA
191D12-9
HEPA
filter

VC008G, DVC261, DVC265



Bolsa reutilizable
197899-3

Set de bolsas de nylon con filtro
(10 ud)
197899-3

Filtro HEPA
191Y27-2 (VC008G)
127725-2
(DVC261, DVC265)
HEPA
filter

Robots aspiradores Modelos: DRC200 y DRC300

DRC200

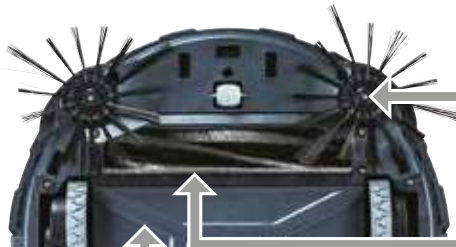

Cinta de marcaje 15m
SH00000231

Filtro de polvo
SH00000314

Cepillos laterales (2 ud)
SH00000065

Cepillo recogedor
SH00000313

Filtro de polvo
SH00000213

DRC300



Set de cinta magnética
5m
191P18-9
Con cinta de doble cara

Filtro de polvo
191P24-4

Cepillos laterales (2 ud)
191P26-0 blando
191P28-6 duro

Cepillos recogedores
191P20-2 blando
191P22-8 duro

blando

duro

Filtro HEPA
191P31-7
HEPA
filter

Almohadilla de protección
191X35-7
Almohadilla que se coloca alrededor del aspirador para absorber impactos con objetos





Código	EAN	P.V.P (€)
A-34235	0088381163293	37,00
122291-4	0088381118668	16,00
122335-0	0088381126878	15,40
122335-2	-	*
122652-8	0088381164030	2,50
123488-8	0088381589765	11,00
123539-7	0088381592987	11,00
126331-0	0088381445740	3,50
126756-8	0088381548403	9,00
127093-3	0088381541619	11,60
127605-2	-	31,50
R 127725-2	0088381575621	10,00
140G04-3	-	8,25
140G19-0	0088381541626	22,00
140G26-3	0088381584180	9,80
140H94-2	0088381544917	4,00
140H95-0	0088381544887	5,50
140J64-3	0088381544924	8,10
R 140K23-3	-	2,00
R 143677-9	0088381526494	1,70
143787-2	0088381485838	32,00
152464-5	3240890072856	4,50
152992-0	0088381539135	32,50
R 162518-0	0088381547864	20,10
162635-6	-	10,50
181575-9	0088381123129	9,00
1910C7-9	-	16,00
1910C9-5	-	18,00
1910D5-0	-	*
R 1910M4-5	-	6,10
1910N0-0	-	22,25
1910R3-2	-	15,50
1910Y3-1	-	13,50
1910Y4-9	-	33,25

Código	EAN	P.V.P (€)
1911B5-2	-	13,50
1911B6-0	-	25,00
1911B7-8	-	28,00
1912R3-4	-	17,00
191657-9	0088381142892	15,40
191C20-4	0088381557443	6,00
191C26-2	0088381557702	23,00
191C30-1	0088381557696	20,00
R 191D12-9	0088381557719	12,30
191D71-3	0088381556637	42,00
191D76-3	0088381556668	6,40
191D79-7	0088381556699	4,70
191E30-3	-	*
191E39-5	0088381565431	11,70
191F81-2	0088381565479	52,00
191G06-2	0088381566001	87,00
191M20-4	0088381575713	67,00
191M30-1	0088381572002	11,60
191P18-9	-	40,00
R 191P20-2	-	47,25
R 191P22-8	-	43,05
R 191P24-4	-	31,50
R 191P26-0	-	18,70
R 191P28-6	-	16,80
R 191P31-7	-	12,00
191R02-6	0088381580564	12,00
191T96-3	-	21,00
191V67-2	0088381586023	24,00
191V68-0	0088381586030	9,90
191V69-8	0088381586047	43,00
191V70-3	0088381586054	30,00
191X35-7	0088381587846	14,40
R 191Y27-2	-	16,05
192035-6	0088381101561	20,00

Código	EAN	P.V.P (€)
192236-6	0088381117746	6,00
192349-3	0088381126229	8,20
192419-8	0088381158640	3,50
192518-6	0088381132237	14,50
192562-3	0088381141116	9,70
192563-1	0088381141123	9,30
192613-2	0088381140843	15,40
193036-7	0088381154390	29,00
193449-2	0088381160490	7,20
193472-7	0088381174022	49,00
193733-5	0088381182492	31,50
198440-5	0088381194648	146,00
194566-1	0088381351270	4,00
194733-8	0088381358972	2,40
194934-8	0088381356756	11,60
195173-3	0088381361125	7,50
195179-1	0088381361194	9,00
195239-9	0088381361804	52,00
195385-8	0088381369381	71,00
195432-5	0088381369473	7,50
195433-3	0088381370264	63,00
195434-1	0088381370271	63,00
195435-9	0088381370288	117,00
195436-7	0088381370295	77,00
195437-5	0088381370301	50,00
195439-1	0088381370493	107,00
195545-2	0088381370325	7,20
195546-0	0088381370332	4,50
195547-8	0088381370349	3,40
195548-6	0088381370356	8,80
195551-7	0088381370394	29,00
195552-5	-	*
195553-3	-	*
195557-5	0088381370479	27,00



Código	EAN	P.V.P (€)
195559-1	0088381411295	3,60
196074-8	0088381407632	112,00
196520-1	0088381538701	5,50
196845-3	0088381442527	81,00
196858-4	0088381441599	82,00
196961-1	0088381488891	2,00
R 197166-6	0088381449953	66,15
197168-2	0088381449984	57,00
197899-3	0088381468060	28,00
197901-2	0088381468084	7,00
198149-9	0088381475020	15,40
198362-9	0088381483636	11,80
198440-5	0088381487368	146,00
198527-3	0088381484299	15,40
198529-9	0088381484312	15,40
198533-8	0088381484336	26,00
198537-0	0088381484374	7,70
198538-8	0088381484381	5,80
198540-1	0088381484404	5,80
198544-3	0088381484442	8,80
198545-1	0088381484459	8,80
198547-7	0088381484473	8,80
198552-4	0088381484527	5,80
198553-2	0088381484534	5,80
198555-8	0088381484558	5,80
198560-5	0088381484589	25,00
198747-9	-	3,70
198749-5	-	7,50
198751-8	0088381490450	4,40
198757-6	0088381495899	61,00
198915-4	0088381497497	7,90
198990-0	0088381519335	2,35
198992-6	0088381519359	2,35
199041-2	0088381524995	7,70

Código	EAN	P.V.P (€)
199142-6	0088381524339	107,00
199143-4	0088381524346	20,00
199388-4	0088381533874	63,00
199439-3	0088381537162	4,10
199454-7	0088381539685	31,00
199486-4	-	*
199491-1	0088381536905	39,00
199493-7	0088381539142	20,00
199618-3	0088381545303	7,00
199624-8	0088381545297	8,80
199627-2	0088381545327	11,50
199773-1	0088381542807	248,00
R 199966-0	0088381546515	7,60
199971-7	0088381546171	5,60
199989-8	0088381546522	8,20
410306-2	0088381123709	3,60
410899-9	0088381155052	1,50
413J77-0	-	*
456914-5	0088381141352	5,50
415452-6	0088381142717	3,70
416041-0	0088381141284	1,50
417853-4	0088381170833	1,10
418500-0	0088381495509	3,05
R 422268-2	-	0,35
422437-5	0088381544900	8,50
R 422440-6	-	0,55
422449-8	-	2,95
422908-2	-	1,05
422909-0	-	0,30
R 424208-6	0088381588508	0,40
424804-0	-	*
451241-5	0088381362733	2,30
413859-0	0088381453769	1,50
451244-9	3240890273475	4,30

Código	EAN	P.V.P (€)
R 451329-1	0088381361422	1,60
451424-7	0088381366847	2,35
456586-6	-	1,00
456587-4	-	2,10
R 457801-1	-	4,75
458184-2	0088381536028	7,00
R 458467-0	-	0,60
458891-7	0088381559058	3,50
458919-1	8720023001014	1,75
459056-4	0088381544894	2,65
459353-8	-	2,45
459356-2	0088381556897	2,45
A-47846	0088381313360	34,00
JM27000090	3240890357519	0,80
P-70346	0088381700900	32,00
P-70378	0088381700931	25,00
P-70421	0088381700986	20,00
P-70437	0088381700993	37,00
P-72908	0088381703567	26,00
P-72942	0088381703604	30,00
P-81739	0088381457552	39,00
P-81745	0088381457569	22,00
P-81789	0088381457385	28,00
P-84084	0088381483896	70,00
R SH00000313	-	90,30
R SH00000314	-	44,10
R SH00000065	0088381479158	50,40
R SH00000213	0088381479189	89,25
R SH00000231	0088381475877	64,05
W107402706	-	15,40
W107418350	0088381490122	35,00
W107418688	0088381519946	30,00
W6084	0088381431095	5,50



Accesorios de recogida de polvo

Manguera de 28mm

Pág. 305 / 298



Largo (m)	Tipo	Adaptador	Incluye	Unds.	Código	EAN	P.V.P. (€)
1	Manguera antiestática	Sin adaptador	-	1	143787-2	0088381485838	32,00
1,5		Adaptador 38mm	-		152992-0	-	32,50
1,5		Adaptador 38mm	Adaptador 22mm		A-34235	0088381163293	37,00
2,5		Adaptador 22mm	Adaptador 38, 24mm		195437-5	0088381370301	50,00
3,5		Adaptador 38mm	Adaptador 22, 24mm		195433-3	0088381370264	63,00
5		Adaptador 38mm	Adaptador 22, 24mm		195436-7	0088381370295	77,00

Manguera de 38mm

Pág. 305



Pág. 306 / 298



Largo (m)	Tipo	Adaptador	Incluye	Unds.	Código	EAN	P.V.P. (€)	Largo (m)	Tipo	Adaptador	Unds.	Código	EAN	P.V.P. (€)
1,5	Manguera antiestática	Adaptador 32A	Tubo curvo	1	199388-4	0088381533874	63,00	1,0	Manguera antiestática	Adaptador 32mm	1	199453-9	0088381539043	17,60
1,7	Manguera antiestática	Adaptador 32A	Tubo curvo	1	199493-7	0088381539142	20,00	1,5	Manguera antiestática	Adaptador 38mm	1	198757-6	0088381495899	61,00
							2,5	195434-1				0088381370271	63,00	
							5	195435-9				0088381370288	117,00	

Manguera tipo B de 32mm



Pág. 298

Largo (m)	Tamaño	Modelo	Unds.	Código	EAN	P.V.P. (€)
4	32B	VC3012L/M, VC4210L/M	1	P-84084	0088381483896	70,00
3,5		VC2012L, VC2512L, VC3011L		P-81739	0088381457552	39,00

Adaptadores 28mm



Tipo	Manguera	Adaptador	Unds.	Código	EAN	P.V.P. (€)
Adaptador de 22mm	Manguera de 28mm sin adaptador	22mm	1	195547-8	0088381370349	3,40
Adaptador de 38mm	Manguera de 28mm sin adaptador	38mm		195545-2	0088381370325	7,20
Adaptador de 24mm	Manguera con adaptador de 22 o 38mm	24mm		195546-0	0088381370332	4,50
Adaptador de 25mm	Manguera con adaptador de 24mm	22mm		192349-3	0088381126229	8,20
Adaptador de 18-21mm	Manguera con adaptador de 22mm	Para tubos de 18-21mm		192202-3	-	-

Accesorios de recogida de polvo

Conexiones



Tipo de conexión	Adaptador	Unds.	Código	EAN	P.V.P (€)
C38	32x38mm	1	191M79-1	0088381575799	10,00
B35	32x35mm		191M78-3	0088381575782	10,00
A32	32x32mm		191M77-5	-	*

Tubos curvos 28mm



Manguera y adaptadores compatibles	Tubo compatible	Unds.	Código	EAN	P.V.P (€)
Manguera de 28mm sin adaptador	28L	1	127093-3	0088381541619	11,60
Adaptador 32A			140G26-3	0088381584180	9,80
Manguera de 28mm sin adaptador	28		126756-8	0088381548403	9,00
Adaptador 32A			458184-2	0088381536028	-

Tubo curvo inox. 32mm



Modelo	Unds.	Código	EAN	P.V.P (€)
VC4210L/M	1	P-70346	0088381700900	32,00

Set completo

Tubo flexible 38mm x 2,5m
Tubo recto y curvo
Pie de aspiración
Boquilla de ranuras



Código	EAN	P.V.P (€)
195439-1	0088381370493	107,00

Tubo de aluminio

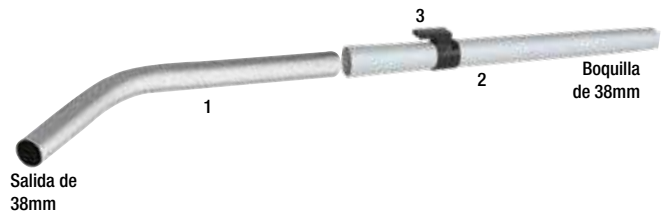

Salida de 38mm

Largo (m)	Tipo	Material	Unds.	Código	EAN	P.V.P (€)
1	Tubo curvo	Aluminio	1	192562-3	0088381141116	9,70
2	Tubo recto	Aluminio		192563-1	0088381141123	9,30
3	Tornillo M4x20 + tuerca	-		911138-5	-	0,35

Tubo de extensión inox. 32mm



Modelo	Descripción	Unds.	Código	EAN	P.V.P (€)
VC4210L/M	ø35x350mm 3pcs	1	W107418350	0088381490122	35,00
VC2012L, VC2512L, VC3011L	ø35x350mm 2pcs negro		P-72942	0088381703604	30,00

Accesorios para DCL501



Modelo	Descripción	Unds.	Código	EAN	P.V.P (€)
Manguera	-	1	SH00000034	-	84,00
Tubo recto	Longitud ajustable		SH00000060	-	79,80
Cepillo para suelo	Alfombra y suelo		SH00000058	-	26,00
Boquilla para ranuras	-		SH00000042	0088381467056	12,70

Pies de aspiración 32



Modelo	Tipo	Húmedo/seco	Unds.	Código	EAN	P.V.P (€)
VC4210L/M	D36 x 300	Húmedo/seco	1	P-81789	0088381457385	28,00
VC2012L, VC2512L, VC3011L	D36 x 260	Húmedo/seco		W107402706	-	15,40
VC2012L, VC2512L, VC3011L	Tipo universal	Húmedo/seco		W14295	4005337142955	4,40



Accesorios de recogida de polvo

Conexión con adaptador de 38mm

Tipo	Adaptador	Salida	Unds.	Código	EAN	P.V.P. (€)
 Adaptador de 24mm	Adaptador 22 y 38mm	Adaptador 24mm	1	195546-0	0088381370332	4,50
 Conexión de 22-38mm	Adaptador 38mm	Adaptador 22mm		195548-6	0088381370356	8,80
 Conexión de 38mm	Adaptador 38mm	Adaptador 28mm		418500-0	0088381495509	3,05
 Conexión estrecha 38mm	Adaptador 38mm	Adaptador 38mm		415021-3	-	*
 Conexión de 70	Adaptador 38mm	Tubo 70mm		181575-9	0088381123129	8,60

Cepillo de secado de parabrisas



Modelo	Unds.	Código	EAN	P.V.P. (€)
DUB185, DUB186, UB100D, UB101D, UB1103	1	191M32-7	0088381572019	12,00

Boquillas de ranuras 30



Modelo	Descripción	Unds.	Código	EAN	P.V.P. (€)
VC4210L/M	ø35x300 mm	1	W6084	0088381431095	5,50
VC2012L, VC2512L, VC3011L	ø35x200 mm		W29541	3240890360908	4,70

Boquilla de aspiración y soplado



Modelo	Tamaño (mm)	Unds.	Código	EAN	P.V.P. (€)
DUB182, DVC350	220	1	132025-7	0088381122856	4,10
	430		134182-7	0088381156998	11,10
UB100D, UB101D, DUB185, DUB186, UB1103	220		123245-4	0088381451215	5,80
	430		123246-2	0088381437332	13,50

Adaptador de herramientas

Modelo	Descripción	Unds.	Código	EAN	P.V.P. (€)
VC2012L, VC2512L, VC3011L	Adaptador de 22mm de cambio rápido	1	W107418661	-	20,00
VC4210L/M	Adaptador para manguera 24mm		P-70378	0088381700931	25,00
	Adaptador para manguera 38mm		W107418688	0088381519946	30,00
VC2012L, VC2512L, VC3011	Adaptador para tubo con regulador de aire	1	P-81745	0088381457569	22,00
VC4210L/M, VC2012L, VC2512L, VC3011L	Conexión 25-50mm	1	192349-3	0088381126229	8,20
	Adaptador 35-38mm		P-70421	0088381700986	20,00
VC4210L/M	Adaptador para tubo 24mm	1	P-70415	0088381700979	10,50
	Adaptador para tubo 38mm		P-70421	0088381700986	20,00

Cepillo con púas



Modelo	Unds.	Código	EAN	P.V.P. (€)
DUB185, DUB186, UB100D, UB101D, UB1103	1	191M30-1	0088381572002	11,60

Tobera larga curva



Modelo	Unds.	Código	EAN	P.V.P. (€)
UB100D, UB101D, DUB185, DUB186, UB1103	1	191G09-6	0088381561846	7,00

Filtros y bolsas

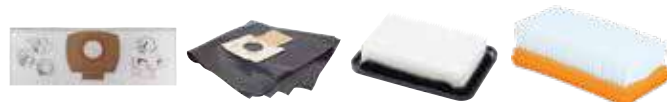

Modelo	Descripción	Unds.	Código	EAN	P.V.P. (€)
VC2012L, VC2512L, VC3011L	Bolsa de fieltro	5	P-72899	0088381703550	28,00
	Bolsa de plástico		P-70297	0088381700856	30,00
VC4210L/M	Cartucho filtro nylon	1	W107418351	0088381490139	66,00
	Cartucho filtro lateral		W107418352	0088381490146	39,00
	Bolsa de papel	5	W107418353	0088381490153	39,00
	Bolsa de plástico		W107418355	0088381490177	35,00

Accesorios para aspiradores

Tobera extra-larga



* usar con J22 195547-8

Modelo	Color	Unds.	Código	EAN	P.V.P. (€)
DVC350, UB100D, UB101D, DUB185, DUB186	Gris	1	192236-6	008838117746	6,00

Depósito de polvo



Modelo	Unds.	Código	EAN	P.V.P. (€)
DUB185, DUB186, UB100D, UB101D, UB1103	1	123241-2	0088381437103	8,70
UB1100, UB1101		122321-1	-	3,50

Tubo flexible



Modelo	Unds.	Código	EAN	P.V.P. (€)
DUB185, DUB186, UB100D, UB101D, UB1103	1	191M34-3	0088381572026	14,90

Cajón recogepolvo



Modelo	Unds.	Código	EAN	P.V.P. (€)
LS0714, LS0714F, LS0714FL, LS1216, LS1216FL, LS1216L	1	194175-6	0088381349994	40,00



Set de aspiración para 4014N



Boquilla, tubo de aspiración recto, tubo de aspiración flexible y conector.

Modelo	Unds.	Código	EAN	P.V.P. (€)
DUB185, DUB186, UB100D, UB101D, UB1103	1	196643-5	0088381437325	14,70
UB1100, UB1101		191750-9	0088381125130	14,30

Depósito de polvo



Modelo	Unds.	Código	EAN	P.V.P. (€)
Sopladores	DUB185, DUB186, UB100D, UB101D, UB1103	122321-1	-	3,50
Cortadores de diamante	4100K, DCC500, DCC501	126738-0	0088381589802	6,40
Lijadoras de banda	9924DB	122296-4	0088381116282	14,10
	9404, 9903	122591-2	0088381154239	12,70
	9403	122562-9	0088381148184	14,10
	9910, 9911	122548-3	0088381146784	5,80
Sierra de incisión	SP6000	122562-9	0088381148184	14,10
Ingletadoras, ingletadoras telescópicas y sierras de mesa	DLS111, DLS211, DLS714, LS003G, LS004G, LS0714/F/FL/L, LS1019, LS1019L, LS1030N, LS1040/F, LS1216/F/FL/L, LS1219/L, LF1000, LHF1040F	122852-0	0088381356602	3,80
	LH1201FL	JM23100501	0088381373654	3,70
	LS0815F/FL, LH1201FL	JM23510010	0088381447348	7,20
	DLS600	122884-7	-	6,40
Cepillos	1100/N	STEX122312	0088381114974	68,00
	1911B	122402-1	-	33,00
	DKP180, DKP181, KP0810/C, KP001G, KP0800	191C21-2	0088381557450	31,00
Desbastadora de diamante	PC5001C	122853-8	0088381358637	5,20
Engalletadora	DPJ180, PJ7000	123150-5	0088381403092	7,00
Lijadora orbital	BO4900, BO4900V, BO6030	151517-7	0088381150859	8,80
Lijadora Rotorbital	DBO180, DBO480, DBO481, DBO482, BO4556, BO4557, BO4565, BO4566, BO5030, BO5040, BO50412	135222-4	0088381435918	4,90



ROBOT ASPIRADOR

DRC300

**Mapeo con sensor LiDAR (2D)
y sensor de cámara**



Control remoto + Modo de limpieza libre



En el modo de limpieza libre, se puede iniciar inmediatamente sin necesidad de mapear la zona.



Fácil mantenimiento y limpieza



Niveles láser



Trípodes



Tipo	Descripción	Rosca	Unds.	Código	EAN	P.V.P. (€)
1	Tripode aluminio 1,65M máx.	5/8"	1	P-81088	88381449564	90,00
2	Tripode aluminio 2,70M máx.	5/8"	1	P-81315	88381451291	269,00
3	Tripode 1800 para SK209	1/4"	1	TKOLM4001F	88381442374	151,00
4	Tripode 2900 para SK209	1/4"	1	TKOLM5030F	88381442381	218,00
5	Tripode aluminio 1,15m máx SK700D	1/4"	1	LE00874658	088381539876	110,00



Receptores



Descripción	Unds.	Modelo	Código	EAN	P.V.P. (€)
Receptor (Incluye soporte)	1	SK209	TKOLDG301G	0088381488853	343,00
Receptor (Incluye soporte) LR150	1	SKR200	LE00796587	3240890394156	353,00
Soporte del receptor	1	SKR200	LE00784968	3240890394200	71,00
Mando a distancia SKR200	1	SKR200	LE00796588	3240890394163	65,00
Receptor Funciona como mando	1	SK104Z SK103PZ	LE00837085	0088381488877	179,00
Receptor Incluye soporte	1	SK700D SK700GD	LE00855702	0088381535366	236,00
Soporte receptor	1	SK700D	LE00837096	-	54,00
Receptor LDG	1	SK10G	TKOLDG501G	-	243,00



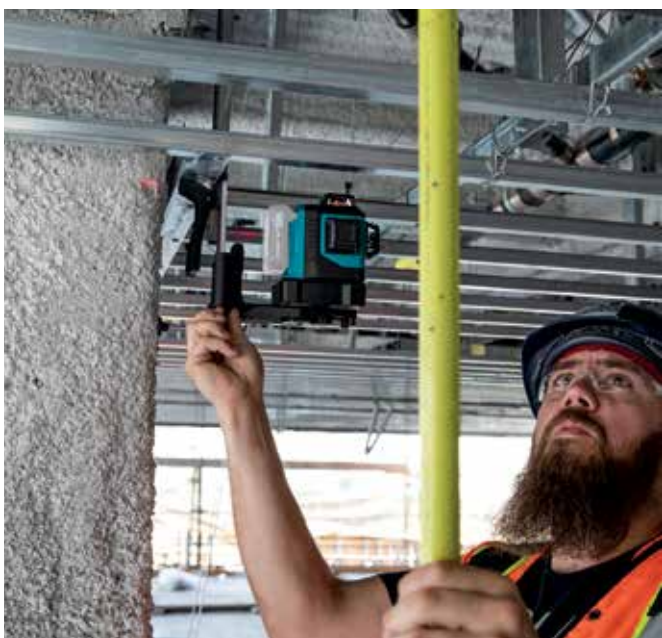

Soportes



	Descripción	Modelo	Unds.	Código	EAN	P.V.P. (€)
1	Soporte pared	SK105D SK105DG SK106D SK106DG SK700D SK700GD	1	LE00785637	3240890328847	131,00
2	Soporte pared	SK105D SK105DG SK106D SK106DG SK700D SK700GD	1	LE00929104	0088381589536	83,00
3	Soporte simple pared	SK105D SK105DG SK106D SK106DG, SK102 SK103P SK104	1	LE00870131	0088381528726	33,00
4	Soporte magnético pared	SK105D SK105DG SK106D SK106DG SK102 SK103P SK104	1	LE00870134	0088381528733	46,00
5	Soporte para pared	SK105D SK105DG SK106D SK106DG SK102 SK103P SK104	1	LE00870137	0088381528757	77,00
6	Soporte imantado	SK104Z SK103PZ	1	LE00785633	3240890347763	15,40
7	Soporte pared	SKR200Z	1	LE00791661	3240890394170	104,00



Escala de aluminio



Longitud	Unds.	Código	EAN	P.V.P. (€)
1,2 - 4,0 m	1	P-81309	0088381451178	77,00

Tarjetas magnéticas

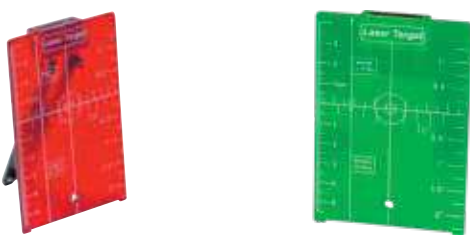

Descripción	Unds.	Código	EAN	P.V.P. (€)
Tarjeta magnética roja	1	LE00785638	3240890328830	17,90
Tarjeta magnética verde	1	LE00823195	0088381851923	25,00

Bolsas de transporte



LE00864505

Descripción	Modelo	Unds.	Código	EAN	P.V.P. (€)
Bolsa funda	SK104Z SK103PZ	1	LE00822220	-	31,00
Bolsa funda	SK105D SK105GD SK106D SK106GD	1	LE00864505	0088381549547	39,00
Bolsa funda	SK700D SK700GD	1	LE00929103		46,00

Gafas para mejorar la visión del láser



Descripción	Unds.	Código	EAN	P.V.P. (€)
Gafas para láser Rojo (1)	1	LE00834534	-	20,00
Gafas para láser Verde (2)	1	LE00772796	-	26,00
Gafas para láser Verde (1)	1	TK02100200	-	20,00

Cables USB



Permite usar una batería LXT de 18V cuando se usa con el adaptador para USB ADP05 (se vende por separado).

Descripción	Modelo	Unds.	Código	EAN	P.V.P. (€)
Cable USB	SK209	1	199010-3	0088381519663	13,80
Cable usb	SK105 SK106	1	199178-5	0088381528238	11,00



Adaptador tipo batería para SK700



Descripción	Unds.	Código	EAN	P.V.P. (€)
Adaptador ADP09 para SK700	1	CP00000001	0088381548571	33,00



Roedoras, cizallas y punzonadora



Capacidad en corte circular JN1601 y JN3201

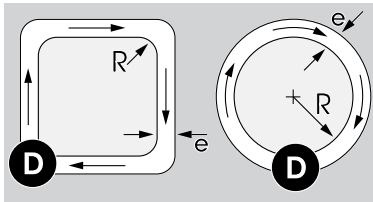

D	21 mm.	JN1601
e	5 mm.	
R	50 mm.	
D	42 mm.	JN3201
e	8 mm.	
R	128 mm.	

JS8000



Descripción	Unds.	Código	EAN	P.V.P (€)
Cabezal completo	1	125354-5	3240890285218	139,85
Cuchilla central	1	725129-8	88381341455	73,00
Cuchilla lateral	1	725130-3	88381341448	62,00

Troqueles



Modelo	Unds.	Código	EAN	P.V.P (€)
JN1601 DJN161	1	A-83951	0088381146630	28,00
JN3200 JN3201	1	792728-1	0088381103602	29,00

Cuchilla central



Modelo	Unds.	Código	EAN	P.V.P (€)
JS1601	1	792534-4	0088381105477	63,00
JS1000	1	792537-8	0088381105484	81,00

Juego de cuchillas



Modelo	Unds.	Código	EAN	P.V.P (€)
JS1602	1	191383-0	008838111874	31,00
JS1601	1	792533-6	0088381105453	48,00
JS1000	1	792536-0	0088381105460	48,00
JS3200 JS3201	1	792287-5	0088381103589	34,00

Matrices



Modelo	Unds.	Código	EAN	P.V.P (€)
JN1601 DJN161	1	A-15051	0088381130219	24,00
JN3200 JN3201	1	792292-2	0088381103619	28,00

Juego de galgas



Modelo	Unds.	Código	EAN	P.V.P (€)
JS1601	1	762013-6	0088381102162	4,10
JS3200 JS3201	1	762007-1	0088381102155	4,70

Llaves allen

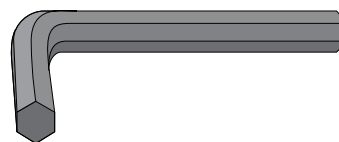

Modelo	Unds.	Código	EAN	P.V.P (€)
JS1601 JS1602 JS1000 JN3201	1	783201-2	0088381101288	1,10
JN1601	1	783208-8	0088381152624	1,10
JS3200 JS3201	1	783202-0	0088381102667	1,10

Llaves para roedoras



Modelo	Unds.	Código	EAN	P.V.P (€)
JN1601	1	781028-4	0088381152600	3,20
JN3200 JN3201	1	781019-5	0088381102452	3,30

Arandela suplementaria

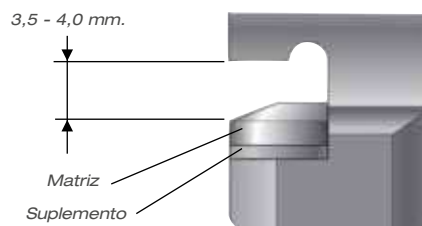

Modelo	Unds.	Código	EAN	P.V.P (€)
JN3200 JN3201	1	341796-7	0088381155298	1,10

Accesorios para DJS200

Cuchillas para DJS200



725092-5



725255-3



725093-3

Descripción	Unds.	Código	EAN	P.V.P (€)
Cuchilla superior	1	725092-5	-	43,00
Cuchilla central	1	725255-3	-	69,50
Cuchilla inferior	1	725093-3	-	46,00



Accesorios para DPP200

Base



Descripción	Unds.	Código	EAN	P.V.P (€)
Base	1	SC03801080	0088381492201	94,00

Topes deslizante



Descripción (mm)	Unds.	Código	EAN	P.V.P (€)
Tope deslizante	1	SC03300790	0088381492195	86,00



Accesorios para DPP200

Punzones redondos



Descripción (mm)	Unds.	Código	EAN	P.V.P (€)
Punzón 6	1	SC05340040	0088381493161	116,00
Punzón 6,5	1	SC05340050	0088381493178	116,00
Punzón 8	1	SC05340060	0088381493185	116,00
Punzón 8,5	1	SC05340070	0088381493192	116,00
Punzón 10	1	SC05340080	0088381493208	116,00
Punzón 11	1	SC05340090	0088381493215	116,00
Punzón 12	1	SC05340100	0088381493222	116,00
Punzón 13	1	SC05340110	0088381493239	116,00
Punzón 14	1	SC05340120	0088381493246	116,00
Punzón 15	1	SC05340130	0088381493253	116,00
Punzón 16	1	SC05340140	0088381493260	116,00
Punzón 18	1	SC05340150	0088381493277	116,00
Punzón 20	1	SC05340160	0088381493284	116,00

Punzones estadio



Descripción (mm)	Unds.	Código	EAN	P.V.P (€)
Punzón 6,5x10	1	SC05340200	0088381493291	159,00
Punzón 6,5x13	1	SC05340210	0088381493307	159,00
Punzón 8,5x13	1	SC05340220	0088381493314	159,00
Punzón 8,5x17	1	SC05340230	0088381493321	159,00
Punzón 9x13,5	1	SC05340240	0088381493338	159,00
Punzón 9x18	1	SC05340250	0088381493345	159,00
Punzón 10x15	1	SC05340260	0088381493352	159,00
Punzón 10x20	1	SC05340270	0088381493369	159,00
Punzón 11x16,5	1	SC05340280	0088381493376	159,00
Punzón 12x18	1	SC05340290	0088381493383	159,00
Punzón 13x19,5	1	SC05340300	0088381493390	159,00
Punzón 14x21	1	SC05340310	0088381493406	159,00

Tope redondos



Descripción (mm)	Unds.	Código	EAN	P.V.P (€)
Tope redondo SB-6	1	SC00000203	0088381191159	116,00
Tope redondo SB-6,5	1	SC00000205	0088381191173	116,00
Tope redondo SB-8,5	1	SC00000207	0088381191197	116,00
Tope redondo SB-8,5	1	SC00000209	0088381191210	116,00
Tope redondo SB-10	1	SC00000211	0088381191234	116,00
Tope redondo SB-11	1	SC00000213	0088381491969	116,00
Tope redondo SB-12	1	SC00000215	0088381491983	116,00
Tope redondo SB-13	1	SC00000217	0088381492003	116,00
Tope redondo SB-14	1	SC00000219	0088381492027	116,00
Tope redondo SB-15	1	SC00000221	0088381492041	116,00
Tope redondo SB-16	1	SC05332710	0088381493093	116,00
Tope redondo SB-18	1	SC00000223	0088381190282	116,00
Tope redondo SB-20	1	SC05352510	0088381190770	116,00

Tope estadio



Descripción (mm)	Unds.	Código	EAN	P.V.P (€)
Tope estadio 6,5x10	1	SC00000244	0088381190497	116,00
Tope estadio 6,5x13	1	SC00000246	0088381190510	116,00
Tope estadio 8,5x13	1	SC00000248	0088381190534	116,00
Tope estadio 8,5x17	1	SC00000250	0088381190558	116,00
Tope estadio 9x13,5	1	SC00000252	0088381190572	116,00
Tope estadio 9x18	1	SC00000254	0088381190596	116,00
Tope estadio 10x15	1	SC00000256	0088381190619	116,00
Tope estadio 10x20	1	SC00000258	0088381190633	116,00
Tope estadio 11x16,5	1	SC00000260	0088381190657	116,00
Tope estadio 12x18	1	SC00000262	0088381190671	116,00
Tope estadio 13x19,5	1	SC00000264	0088381190688	116,00
Tope estadio 14x21	1	SC00000266	0088381190701	116,00

Jardín



SIERRAS DE CADENA

Sierras de cadena para tala

XGT



UC011

- 350 mm
- 0 - 25,5 m/s
- 52 eslab.



UC012

- 400 mm
- 0 - 25,5 m/s
- 56 eslab.



18v + 18v → **36v**



DUC355

- 350 mm
- 0 - 20 m/s
- 52 eslab.

18v LITHIUM-ION

NOVEDADES



DUC407

- 400 mm
- 0 - 7,7 m/s
- 56 eslab.



DUC357

- 350 mm
- 0 - 7,7 m/s
- 52 eslab.

Sierras de cadena de altura

XGT

NOVEDADES

UA004G

- 300 mm
- 0 - 20 m/s
- 46 eslab.



UA003G

- 300 mm
- 0 - 20 m/s
- 46 eslab.

18v + 18v → **36v**

DUC355

- 350 mm
- 0 - 20 m/s
- 52 eslab.



DUC355

- 350 mm
- 0 - 20 m/s
- 52 eslab.





XGT
40V Li-ion
max



18V + 18V → **36V**



18V
LITHI-ION

Sierras de cadena para poda

XGT



UC002
- 250 mm
- 0 - 24,8 m/s
- 46 eslab.



UC003
- 300 mm
- 0 - 24,8 m/s
- 46 eslab.



UC004
- 350 mm
- 0 - 24,8 m/s
- 52 eslab.



UC006
- 350 mm
- 0 - 25,5 m/s
- 52 eslab.

18V + 18V → **36V**



DUC406
- 400 mm
- 0 - 20 m/s
- 56 eslab.



DUC306
- 300 mm
- 0 - 20 m/s
- 46 eslab.



DUC256
- 250 mm
- 0 - 20 m/s
- 40 eslab.



DUC256C
- 250 mm
- 0 - 20 m/s
- 60 eslab.



DUC252
- 250 mm
- 8,3 m/s
- 40 eslab.

18V
LITHI-ION



DUC254
- 250 mm
- 0 - 24 m/s
- 40 eslab.



DUC254C
- 250 mm
- 0 - 22,5 m/s
- 60 eslab.



DUC306
- 115 mm
- 5 m/s
- 42 eslab.



DUC101
- 100 mm
- 8 m/s
- 26 eslab.

NOVEDAD

12V
LITHI-ION



UC100D
- 100 mm
- 8 m/s
- 26 eslab.

NOVEDAD



Cadenas, barras y protectores para sierras de cadena

Modelo	Longitud	Paso de cadena	Galga	Cadena			Tipo	Corte	Eslabones	
				Código	EAN	P.V.P. (€)				
	UC002G	25	3/8"b.p	1,1mm/0,043	191H00-0	0088381562867	12,00	90PX	CC	40
	UC003G	30	3/8"b.p	1,1mm/0,043	191H01-8	0088381562874	20,00	90PX	CC	46
	UC004G	35	3/8"b.p	1,1mm/0,043	191H02-6	0088381562881	20,00	90PX	CC	52
	UC006G	25	1/4"	1,3mm/0,050	191G96-5	0088381562829	29,50	25AP	MC	60
	UC011G	35	0,325	1,1mm/0,043	191T91-3	0088381585095	30,00	80TXL	MC	59
	UC012G	40	0,325	1,1mm/0,043	191T92-1	0088381590754	32,50	80TXL	MC	64
	DUC122	11,5	1/4"	1,3mm/0,050	191G95-7	0088381562812	21,00	25AP	MC	42
	DUC252	25	3/8"b.p	1,3mm/0,050	191H08-4	0088381562942	18,00	91PX	CC	40
	DUC101	10	0,325	1,1mm/0,043	1910V6-4	0088381597579	14,00	80TXL	MC	26
	UC100D	10	0,325	1,1mm/0,043	1910V6-4	0088381597579	14,00	80TXL	MC	26
	DUC254	25	3/8"b.p	1,1mm/0,043	191H00-0	0088381562867	12,00	90PX	CC	40
	DUC254C (carving)	25	1/4"	1,3mm/0,050	191G96-5	0088381562829	29,50	25AP	MC	60
	DUC256	25	3/8"b.p	1,1mm/0,043	191H00-0	0088381562867	12,00	90PX	CC	40
	DUC306	30	3/8"b.p	1,1mm/0,043	191H01-8	0088381562874	20,00	90PX	CC	46
	DUC406	40	3/8"b.p	1,1mm/0,043	191H03-4	0088381562898	22,00	90PX	CC	56
	DUC256C (carving)	25	1/4"	1,3mm/0,050	191G96-5	0088381562829	29,50	25AP	MC	60
	DUC355	35	3/8"b.p	1,1mm/0,043	191H02-6	0088381562881	20,00	90PX	CC	52
	DUC357	35	3/8"b.p	1,1mm/0,043	191H02-6	0088381562881	20,00	90PX	CC	52
	DUC407	40	3/8"b.p	1,1mm/0,043	191H03-4	0088381563888	22,00	90PX	CC	52
	UA003G	30	3/8"b.p	1,1mm/0,043	191H01-8	0088381562874	20,00	90PX	CC	46
	UA004G									
	DUA300									
	DUA301									
	UC3550A	35	3/8"b.p	1,3mm/0,050	191H11-5	0088381562973	15,00	91PX	CC	52
	UC4050A	40	3/8"b.p	1,3mm/0,050	191H12-3	0088381562980	20,00	91PX	CC	52

Cadenas, barras y protectores para sierras de cadena



Diámetro lima	Lima	Barra			Tipo	Protector			Dientes	Piñón motor	
		Código	EAN	P.V.P. (€)		Código	EAN	P.V.P. (€)			
4,5mm	953003100	191G14-3	0088381563857	15,50	Piñón	452093-7 R	0088381423649	2,10	7	3/8"	191V90-7
4,5mm	953003100	191G15-1	0088381563864	17,00	Piñón	419288-5	0088381538466	3,50	7	3/8"	191V90-7
4,5mm	953003100	191G16-9	0088381563871	18,00	Piñón	419288-5	0088381538466	3,50	7	3/8"	191V90-7
4,0mm	953003090	168395-8	0088381200097	55,00	Sólida	452093-7 R	0088381423649	2,10	7	1/4"	191V92-3
4,0mm	953003090	191T87-4	0088381585064	19,00	Piñón	419288-5	0088381538466	3,50	8	0,325"	191V91-5
4,0mm	953003090	191T88-2	0088381590778	21,50	Piñón	419242-9	0088381585835	2,80	8	0,325"	191V91-5
4,0mm	953003090	158476-6	0088381354660	21,00	Sin piñón	-	-	-	7	1/4"	221527-9
4,0mm	953003090	191G22-4	0088381563932	15,00	Piñón	452093-7 R	0088381423649	2,10	7	3/8"	221526-1
-	198457-8	1910W0-3	0088381789561	20,00	Piñón	-	-	-	7	0,325"	227947-5
-	198457-8	1910W0-3	0088381789561	20,00	Piñón	-	-	-	7	0,325"	227947-5
4,5mm	953003100	191G14-3	0088381563857	15,50	Piñón	452093-7 R	0088381423649	2,10	7	3/8"	199063-2
4,0mm	953003090	168395-8	0088381200097	55,00	Sólida	452093-7 R	0088381423649	2,10	7	1/4"	198259-2
4,5mm	953003100	191G14-3	0088381563857	15,50	Piñón	452093-7 R	0088381423649	2,10	7	3/8"	199063-2
4,5mm	953003100	191G15-1	0088381563864	17,00	Piñón	419288-5	0088381538466	3,50	7	3/8"	199063-2
4,5mm	953003100	191G17-7	0088381563888	19,00	Piñón	419242-9	0088381585835	2,80	7	3/8"	199063-2
4,0mm	953003090	168395-8	0088381200097	55,00	Sólida	452093-7 R	0088381423649	2,10	7	1/4"	198259-2
4,5mm	953003100	191G16-9	0088381563871	18,00	Piñón	419288-5	0088381538466	3,50	7	3/8"	199063-2
4,5mm	953003100	191G16-9	0088381563871	18,00	Piñón	419288-5	0088381538466	3,50	7	3/8"	199063-2
4,5mm	953003100	191G17-7	0088381562898	19,00	Piñón	419242-9	0088381585835	2,80	7	3/8"	199063-2
4,5mm	953003100	191G15-1	0088381563864	17,00	Piñón	419288-5	0088381538466	3,50	7	3/8"	226992-7
4,0mm	953003090	191G24-0	0088381563956	18,00	Piñón	419288-5	0088381538466	3,50	7	3/8"	221521-1
4,0mm	953003090	191G25-8	0088381563956	19,00	Piñón	419242-9	0088381585835	2,80	7	3/8"	221521-1





Calibrador de cadena



Descripción	Unds.	Código	EAN	P.V.P. (€)
Calibrador	1	953100090	4002829111956	6,60

Lima plana



Descripción	Unds.	Código	EAN	P.V.P. (€)
Lima plana	1	953003060	4002829111659	6,90

Set de calibrado / afilado



Incluye	Unds.	Código	EAN	P.V.P. (€)
Lima redonda 4mm (x2), soporte, mango (x2) y calibre de profundidad.	1	D-72154	0088381568340	25,00
Lima redonda 4,5mm (x2), soporte, mango (x2) y calibre de profundidad.	1	D-72160	0088381568357	25,00

Lima redonda



Ø de lima	Tipo de cadena	Unds.	Código	EAN	P.V.P. (€)
Mango de lima		1	273646-7	-	2,45
4,0 mm - 5/32"	91VG, 90SG, 80TXL, 25AP	1	953003090	4002829111703	2,30
4,5 mm	90PX	1	953003100	-	2,30
4,8 mm - 3/16"	95VP, 21BP	1	953003070	4002829111666	2,30
5,2 mm - 3/64"	73LP, 73DP0	1	953003110	4002829477212	2,30
5,5 mm - 7/32"	73LP, 73DP	1	953003040	4002829111628	2,30

Conjunto porta-lima



Ø de lima	Tipo de cadena	Unds.	Código	EAN	P.V.P. (€)
4,0 mm - 5/32"	91VG, 90SG	1	953030010	4002829111871	16,00
4,8 mm - 3/16"	95VP, 21BP	1	197712-5	-	8,00
5,5 mm - 7/32"	73LP, 73DP	1	953009000	4002829111857	14,90



Accesorios pistola de soplado AS001G



Descripción	Unds.	Código	EAN	P.V.P. (€)
Boquilla lugares estrechos	1	191X11-1	0088381589642	2,20



Boquilla limpieza filtros	1	191X13-7	0088381589659	2,20
---------------------------	---	----------	---------------	------



Boquilla soplado	1	191X15-3	0088381589666	2,20
------------------	---	----------	---------------	------



Boquilla inflado	1	191X17-9	0088381589697	2,80
------------------	---	----------	---------------	------



Boquilla ancha	1	191X19-5	0088381589680	5,00
----------------	---	----------	---------------	------



Descripción	Unds.	Código	EAN	P.V.P. (€)
Boquilla tubo flexible	1	191X21-8	0088381589673	14,30

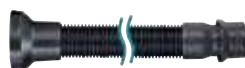

Set manguera ventilación	1	191X23-4	0088381589703	18,70
--------------------------	---	----------	---------------	-------



Boquilla goma 20-30	1	191X25-0	0088381589727	4,40
---------------------	---	----------	---------------	------



Boquilla goma 65	1	191X27-6	0088381589734	5,00
------------------	---	----------	---------------	------



Boquilla larga rincones	1	191X78-9	0088381589741	9,40
-------------------------	---	----------	---------------	------



Filtro c completo	1	191X29-2	0088381589710	5,00
-------------------	---	----------	---------------	------



Accesorios para sopladores



DUB186SF



UB101DZ



DUB363Z

Boquilla



Código	EAN	P.V.P. (€)
123245-4	0088381451215	5,80

Tobera 430 mm



123246-2	0088381437332	13,50
----------	---------------	-------

Tobera larga curva



191G09-6	0088381561846	7,00
----------	---------------	------

Boquillas cónicas



192236-6	0088381561846	6,00
----------	---------------	------

Mangueras flexibles



196643-5	0088381437325	14,70
----------	---------------	-------

Cepillo púas



191M30-1	0088381572002	11,60
----------	---------------	-------

Cepillo secado



191M32-7	0088381572019	12,00
----------	---------------	-------

Aspiración



191M34-3	0088381572026	14,90
----------	---------------	-------

Tubo



Adaptador



Kit de aspiración



Código	EAN	P.V.P. (€)
191P37-5	-	75,00

Extensión



197888-8	-	*
----------	---	---

Boquilla plana



197889-6	0088381475013	7,00
----------	---------------	------

*Consultar disponibilidad

Accesorios para sopladores



DUB361Z

Tubo		
Código	EAN	P.V.P. (€)
452123-4	0088381366373	12,00



Arnés válido para:
DUB361
DUB184

Código	EAN	P.V.P. (€)
166094-6	0088381494977	4,20



DUB184Z

Tubo		
Código	EAN	P.V.P. (€)
183P96-3	-	10,00

Adaptador		
Código	EAN	P.V.P. (€)
191B21-6	-	*

Extensión		
Código	EAN	P.V.P. (€)
183P97-1	0088381583879	11,00



DUB362Z

Tubo		
Código	EAN	P.V.P. (€)
183R02-0	0088381585507	7,00

Adaptador		
Código	EAN	P.V.P. (€)
191J13-3	0088381560887	10,00

Boquilla plana		
Código	EAN	P.V.P. (€)
197889-6	0088381475013	7,00



UB001GZ

Tubo		
Código	EAN	P.V.P. (€)
191P97-7	0088381580359	7,00

Adaptador		
Código	EAN	P.V.P. (€)
191L96-5	0088381569590	11,00

Set de tubos para CANALONES
válido para:
DUB184
UB001G
DUB363

Boquilla plana		
Código	EAN	P.V.P. (€)
197889-6	0088381475013	7,00

Set de tubos		
Código	EAN	P.V.P. (€)
191B03-8	0088381560870	86,00



UB001CZ

Tubo		
Código	EAN	P.V.P. (€)
191L96-5	0088381569590	11,00

Adaptador		
Código	EAN	P.V.P. (€)
191L96-5	0088381569590	11,00

Boquilla plana		
Código	EAN	P.V.P. (€)
197889-6	0088381475013	7,00



UB002CZ

Tubos		
Código	EAN	P.V.P. (€)
413G70-6	-	10,00
162B56-4	-	13,15

Adaptador		
Código	EAN	P.V.P. (€)
1910M7-9	0088381598293	18,00

Adaptador		
Código	EAN	P.V.P. (€)
166094-6	0088381494977	4,20

Boquilla plana		
Código	EAN	P.V.P. (€)
197889-6	0088381475013	7,00

Extensión		
Código	EAN	P.V.P. (€)
197888-8	-	*

*Consultar disponibilidad

Arnés válido para: UB002

Código	EAN	P.V.P. (€)
166094-6	0088381494977	4,20



Accesorios para cortasetos y cortahierbas



	Modelo	Longitud (mm)	Unds.	Peine			Protector de peine			Pala de ramaje		
				Código	EAN	P.V.P. (€)	Código	EAN	P.V.P. (€)	Código	EAN	P.V.P. (€)
	UH201D	200	1	198408-1	0088381483766	30,00	458342-0 R	-	4,45	198401-5	0088381483728	9,10
	DUH651	650	1	196688-3	0088381437547	134,00	-	-	-	194681-1	0088381354349	23,00
	DUH506	500	1	1910H8-2	0088381791885	70,00	-	-	-	1910T1-0	0088381791861	42,00
	DUH606	600	1	1910H9-0	0088381540421	73,00	-	-	-	1910T2-8	0088381791878	42,00
	DUH507D	500	1	1911J1-6	-	62,00	-	-	-	1910T1-0	0088381791861	42,00
	DUH607D	600	1	1911J2-4	-	68,00	-	-	-	1910T2-8	0088381791878	42,00
	DUH601	600	1	191R53-9	0088381583503	110,00	412911-1 R	-	5,30	191R51-3	0088381583565	45,00
	DUH751	750	1	191R54-7	0088381583510	155,00	412912-9 R	-	8,70	191R52-1	0088381583572	73,00
	DUH604S	600	1	191Y03-6	-	131,50	-	-	-	191D33-1	-	31,00
	DUH754S	750	1	-	-	-	-	-	-	191D34-9	0088381559478	36,00
	UH004G	600	1	191R53-9	0088381583503	110,00	412911-1 R	-	5,30	191R51-3	0088381583565	45,00
	UH005	750	1	191R54-7	0088381583510	155,00	412912-9 R	-	8,70	191R52-1	0088381583572	73,00
	UH006G	600	1	191R55-5	0088381583527	155,00	412911-1 R	-	5,30	191R51-3	0088381583565	45,00
	UH007G	750	1	191R56-3	0088381583534	170,00	412912-9 R	-	8,70	191R52-1	0088381583572	73,00
	UH013G	600	1	191Y03-6	-	131,50	-	-	-	191D33-1	-	31,00
	UH014G	750	1	-	-	-	-	-	-	191D34-9	0088381559478	36,00
	UH4861	480	1	140830-8	-	62,00	-	-	-	195050-9	0088381358064	37,00
	UH5570	550	1	194663-3	0088381354141	38,00	-	-	-	194681-1	0088381354349	23,00
	UH6570	650	1	194666-7	0088381354172	44,00	-	-	-	194681-1	0088381354349	23,00
	UH5580	550	1	194671-4	0088381360401	77,00	-	-	-	194681-1	0088381354349	23,00
	UH6580	650	1	196688-3	0088381437547	134,00	-	-	-	194681-1	0088381354349	23,00



Ni-Cd
Ni-Mh

MAK
PAC

SAT



Protectores de peine



Descripción	Unds.	Código	EAN	P.V.P. (€)
Protector de peine cortasetos	1	458342-0	-	4,45
Protector de peine cortahierbas	1	452055-5	0088381371407	2,65

Peines cortasetos / cortahierbas



195272-1



195176-7



191N24-2



Descripción	Unds.	Código	EAN	P.V.P. (€)
Peine cortasetos DUM604	1	195272-1	0088381362399	25,00
Peine cortahierbas DUM604	1	195176-7	-	52,00
Peine cortasetos DUM111	1	191N24-2	0088381580052	24,00
Peine cortahierbas DUM111	1	191N23-4	0088381580045	32,00

Mango extensible



Descripción	Unds.	Código	EAN	P.V.P. (€)
Mango extensible DUM604	1	195187-2	0088381362412	62,00
Mango extensible DUM111	1	198516-8	0088381490238	64,00

Sistema de antidesconexión eléctrica



• Para todos los modelos eléctricos.

Para	Unds.	Código	EAN	P.V.P. (€)
Sierras de cadena	1	158024-1	0088381122955	1,70
Cortasetos	1	194678-0	0088381352079	2,20



Accesorios para multifunción UX01G / DUX60 / DUX18

El sistema multifunción consta de motor y accesorios opcionales muy versátiles, ideal para una amplia gama de aplicaciones.

Motores multifunción a batería.

12 en 1

Una herramienta, múltiples aplicaciones...

XGT

Ahora también con batería XGT



Accesorios para motores multifunción



Prolongador	1	191E27-2	0088381558600	126,00
-------------	---	----------	---------------	--------



Descripción	Unds.	Código	EAN	P.V.P. (€)
Bomba sumergible	1	DEAPF400MP		240,00



Corte rotativo	1	191M75-9	-	496,00
Corte rotativo + barra	1	191M56-3	0088381572132	546,00



Sierra de cadena	1	191T38-7	0088381581271	193,00
------------------	---	----------	---------------	--------



Cortabordes	1	196752-0	0088381437011	161,00
-------------	---	----------	---------------	--------



Recortabordes	1	195566-4	0088381397650	90,00
---------------	---	----------	---------------	-------



Cortasetos de altura recto	1	197750-7	0088381469258	244,00
Cortasetos de altura de ángulo ajustable	1	196345-3	0088381424905	299,00



Descripción	Unds.	Código	EAN	P.V.P. (€)
Cortasetos para suelo	1	198068-9	008838473620	355,00



Desbrozador	1	198768-1	0088381518727	110,00
	1	195663-6	0088381376853	120,00



Cultivador	1	195717-9	008838398060	287,00
------------	---	----------	--------------	--------



Barredor	1	199318-5	0088381533942	582,00
----------	---	----------	---------------	--------



Soplador	1	191P72-3	0088381580212	170,00
----------	---	----------	---------------	--------

Boquilla de salida	1	191C15-7	0088381558747	9,40
--------------------	---	----------	---------------	------



Rodillo de limpieza	1	199339-7	0088381534130	610,00
---------------------	---	----------	---------------	--------



Desbrozadoras

Discos para desbrozadoras

Tipo	Medida (mm)	Interior (mm)	Espesor (mm)	Modelos recomendados	Unds.	Código	EAN	P.V.P. (€)	
	2 PUNTAS	255	25,4	2	DUR369A DUR369L, UR006G, UR007G, UR101C, UR201C	1	198345-9	0088381481458	18,00
	2 PUNTAS (Triturador)	270	25,4	2	UR012G, UR006G, DUR369A	1	199874-5	0088381546614	38,00
	3 PUNTAS	255	25,4	3	DUR369A, UR006G, UR007G, UR101C, UR201C	1	195299-1	0088381364935	21,95
	3 PUNTAS	300	25,4	3	UR012G	1	385224150	4002829752159	25,00
	4 DIENTES	230	25,4	2	DUR190U/L, DUR191U/L, UR368A/L, DUR369A/L, UR002G, UR003G, UR006G, UR007G, UR016G, UR017G, UR101C, UR201C,"	1	DA00000169		15,45
	4 DIENTES	230	25,4	1,8	DUR190U/L, DUR191U/L, UR368A/L, DUR369A/L, UR002G, UR003G, UR006G, UR007G, UR016G, UR017G, UR101C, UR201C, UX01G, DUX60"	1	D-66008	0088381541077	11,00
	4 DIENTES	255	25,4	2	DUR369A/L, UR006G, UR007G, UR016G, UR017G, UR101C, UR201C	1	B-14124	0088381361071	11,85
	8 DIENTES	200	25,4	1,4	DUR194	1	191Y44-2	0088381590884	10,00
	8 DIENTES	230	25,4	1,8	DUR190U/L, DUR191U/L, UR368A/L, DUR369A/L, UR002G, UR003G, UR006G, UR007G, UR016G, UR017G, UR101C, UR201C,"	1	D-73324	0088381582421	12,00
	8 DIENTES	255	25,4	-	DUR369A/L, UR006G, UR007G, UR016G, UR017G, UR101C, UR201C	1	B-14146	0088381361095	13,40
	24 DIENTES	225	25,4	1,8	"DUR190U/L, DUR191U/L, UR368A/L, DUR369A/L, UR002G, UR003G, UR006G, UR007G, UR016G, UR017G, UR101C, UR201C,"	1	199872-9	0088381546638	25,00

Adaptadores de cabezal

Tipo de cabezal	Descripción / Medida	Unds.	Código	EAN	P.V.P. (€)	
	Cabezal manual	Casquillo LH 8x1.25 Casquillo LH 10x1.00 Espárrago LM8x1.25 / 0x1.25"	1	385224250	4002829760161	9,50
	Cabezal T&G medium	Casquillo LH 8x1.25 Casquillo LH 10x1.00 Espárrago LM8x1.25 / 10x1.25"	1	381224230	4002829760147	6,00
	Cabezal T&G large	Casquillo LH 8x1.25 Casquillo LH 10x1.00 Casquillo LH12x1.50 Casquillo LH 12x1.75 Espárrago LM8x1.25 / 10x1.25"	1	382224310	4002829760154	8,50
	Cabezal T&G Small	Casquillo LH 10x1,25	1	UA-1048	-	4,50

* Es necesario utilizar adaptador.

Cabezales de Nylon

- Los cabezales Tap&Go son de carga fácil. No es necesario desmontar el cabezal para cargar el hilo.
- Cinco nuevos cabezales de Nylon para cubrir las necesidades de todos nuestros modelos de desbrozadoras.
- Gama simplificada para facilitar la elección de nuestros clientes.





Tipo cabezal		Rosca	Medida	Espesor	Modelos recomendados	Unds.	Código	EAN	P.V.P. (€)
	TAP&GO	-	-	1,6mm	ET40	1	DA00000002	0088381374033	8,00
	TAP&GO	-	-	1,6mm	DUR181	1	195858-1	0088381400176	7,00
	TAP&GO	M10 x 1.25LH	-	1,6mm	DUR193	1	191Y39-5	0088381592888	8,00
	FIJO	-	-	2,7mm	-	1	384224270	4002829757741	23,00
	FIJO	M8 x 1.25LH	-	2,0mm	DUR182L/R, DUR187L	1	123235-7	0088381498098	11,00
	MANUAL	M10 x 1.25LH	-	2,4mm	DUR190L/U, DUR191L/U, DUR192L, DUR368A, DUR368L, UR002G, UR003G, UR006G, UR007G, UR016G, UR101C, UR201C,	1	385224240	4002829757734	17,00
	TAP&GO	M8 x 1.25RH	100mm	2.0mm x 4m	DUR189, UR100D	1	191D92-5	0088381559300	18,00
	TAP&GO	M8 x 1.25LH	100mm	2.0mm x 4m	DUR187L, DUR188	1	191D91-7	0088381559294	18,00
	TAP&GO	M10 x 1.25LH	100mm	2.4mm x 3m	DUR190L/U, DUR191L/U, DUR192L, DUR368A, DUR368L, UR002G, UR003G, UR006G, UR007G, UR016G, UR101C, UR201C,	1	191D90-9	0088381559287	18,00
	TAP&GO	M10 x 1.25LH	127mm	2.4mm x 2m	UR012G, DUR369A/L, UR007G, UR101C, UR201C	1	191D93-3	0088381559317	26,00
	TAP&GO	M10 x 1.25LH	127mm	2.7mm x 4m	UR012G, DUR369A/L, UR007G, UR101C, UR201C	1	191Y2-9	0088381798822	30,00
	TAP&GO	Estriada	127mm	2.7mm x 4m	UR014G	1	191Y3-7	0088381798839	32,00
	TAP&GO	M8 x 1.25RH	75mm	1.65mm x 8m	UR100D, DUR184	1	198854-8	0088381519571	14,00
	TAP&GO	M8 x 1.25RH	-	2,0mm	DUR184L, DUR189	1	680224200	4002829757703	14,00
	TAP&GO	M10 x 1.25LH	-	2,4mm	DUR190L/U, DUR191L/U, DUR192L, DUR368A, DUR368L, UR002G, UR003G, UR006G, UR007G, UR016G, UR101C, UR201C,	1	381224240	4002829757710	17,00
	TAP&GO	M10 x 1.25LH	-	2,7mm	UR012G, DUR369A/L, UR007G, UR101C, UR201C	1	382224300	4002829757727	20,00

Hilos de nylon





Tipo	Descripción	Ø (mm)	Longitud (m)	Unds.	Código	EAN	P.V.P. (€)	
Redondo	<ul style="list-style-type: none"> Hilo de nylon redondo 1,65X15 metros. Especial para DUR181 	1,65	15	1	196148-5	0088381411523	5,20	
		2,4	5	1	B-01971	0088381120494	2,45	
Redondo	<ul style="list-style-type: none"> Desarrollado para el usuario más exigente en el uso privado. Indicado para desbrozadoras de baja cilindrada. 	3,0	4	1	B-07375	0088381349291	3,30	
		1,3	15	1	369224807	-	2,30	
Round Trim	<ul style="list-style-type: none"> Desarrollado para el usuario más exigente en el uso privado. Dos colores. Indicado para desbrozadoras de baja cilindrada. El hilo redondo ofrece mayor resistencia al aire y al impacto. 	1,6	15	1	369224808	-	2,60	
		2,0	15	1	369224790	4002829756614	2,80	
		2,0	126	1	369224791	4002829756621	11,60	
		2,4	15	1	369224792	4002829756638	3,60	
Round Trim PLUS	<ul style="list-style-type: none"> Desarrollado para el uso privado y semi-profesional. Incrementamos la resistencia al desgaste y el punto de fusión. Indicado para máquinas de mediana cilindrada. 	87	1	369224793	4002829756645	11,80		
		262	1	369224794	4002829756652	31,00		
		15	1	369224809	-	4,40		
		56	1	369224811	-	11,80		
		168	1	369224815	-	31,00		
		3,3	15	1	369224810	-	5,00	
			46	1	369224812	-	11,80	
			139	1	369224816	-	31,00	
		Square Trim PLUS	<ul style="list-style-type: none"> Desarrollado para el uso semi-profesional. Incrementamos la resistencia al desgaste y el punto de fusión. Disminuye la pérdida de rpm por rozamiento gracias a sus aristas. Indicado para máquinas de mediana cilindrada. 	15	1	369224795	-	4,10
				69	1	369224796	-	11,80
206	1			369224797	4002829756775	31,00		
3,0	15			1	369224819	-	5,20	
	44			1	369224821	-	11,80	
	132			1	369224825	-	31,00	
3,3	15			1	369224820	-	5,20	
	36			1	369224822	-	11,80	
	109			1	369224826	-	31,00	
3,5	32			1	369224823	-	11,80	
	96			1	369224827	-	31,00	
4,0	25			1	369224824	-	11,80	
	75	1	369224828	-	31,00			
Round Trim PRO	<ul style="list-style-type: none"> Desarrollado para el uso profesional. Alta resistencia al calor. Para los trabajos más exigentes. Indicado para desbrozadoras de alta cilindrada. Combina dos capas de material con diferentes durezas. 	15	1	369224798	4002829756669	5,20		
		56	1	369224799	4002829756676	14,10		
		168	1	369224800	4002829756683	35,00		
		279	1	369224801	4002829756690	56,00		
Square Trim PRO	<ul style="list-style-type: none"> Desarrollado para el uso profesional. Alta resistencia al calor. Para los trabajos más exigentes. Indicado para desbrozadoras de alta cilindrada. Disminuye la pérdida de rpm por rozamiento gracias a sus aristas. Combina dos capas de material con diferentes durezas. 	15	1	369224802	4002829756782	5,80		
		44	1	369224803	4002829756799	14,10		
		132	1	369224804	4002829756805	36,00		
		219	1	369224805	-	56,00		



Hilos de nylon silenciosos

Tipo	Descripción	Ø (mm)	Longitud (m)	Unds.	Código	EAN	P.V.P. (€)
Linea Cuatro Hojas 	<ul style="list-style-type: none"> Hilo de nylon helicoidal. Forma de cuatro hojas redondeadas que disminuye el nivel de ruido. Gracias a su forma que tiene menos resistencia al aire que la línea redonda de nylon, aporta mayor cantidad de trabajo. En comparación a otros hilos, el tiempo de trabajo aumenta un 20% con una sola carga de batería. Indicado para máquinas a batería. 	2,0	15	1	E-01769	0088381555487	3,30
		2,0	30	1	E-01775	0088381555494	6,20
		2,0	310	1	E-01781	0088381555500	45,00
Linea Cuatro Hojas 		2,4	15	1	E-01797	0088381555517	4,20
		2,4	30	1	E-01806	0088381555524	7,90
		2,4	225	1	E-01812	0088381555531	47,00
Linea Cuatro Hojas 		2,7	15	1	E-01828	0088381555548	4,80
		2,7	30	1	E-01834	0088381555555	8,70
		2,7	180	1	E-01840	0088381555562	45,00



Tipo cabezal	Rosca	Modelo	Descripción	Unds.	Código	EAN	P.V.P. (€)	
	Policut	Universal	"Recomendado para modelos a batería"	Cabezal de cuchillas flotantes recambiables	1	197188-6	0088381458214	30,00
	Juego cuchillas Policut	Universal	"Recomendado para Policut"	12 cuchillas	1	197189-4	0088381458276	24,00
	Policut curvo	Universal	"Recomendado para modelos a batería"	Cabezal de cuchillas flotantes recambiables	1	198383-1	0088381488129	28,00
	Juego cuchillas Policut	Universal	"Para policut curvo"	3 cuchillas	1	198426-9	0088381488143	14,20

Aceites

Aceite de 2T mineral



Cantidad	Unds.	Código	EAN	P.V.P. (€)
100ml	1	980008106	4002829239551	2,05
1 Litro	1	980008107	4002829000274	7,20
1 Litro con dosificador	1	980008112	4002829414477	12,10
5 Litros	1	980008118	4002829486030	33,00

Aceite de 4T HD30 Monogrado



Cantidad	Unds.	Código	EAN	P.V.P. (€)
600ml	1	980008120	4002829441336	4,40

Aceite de 4T SJ10W30 Multigrado



Cantidad	Unds.	Código	EAN	P.V.P. (€)
80ml	1	196122-3	-	2,80
100ml	1	197010-7	0088381452731	5,50

Aceite de 4T 5W30 Multigrado



Cantidad	Unds.	Código	EAN	P.V.P. (€)
1 Litro	1	980008121	4002829760475	8,20

Aceite de 2T sintético



Cantidad	Unds.	Código	EAN	P.V.P. (€)
1 Litro	1	980008103	4002829760314	12,70

Aceite de cadena Biotop (Biodegradable)



Cantidad	Unds.	Código	EAN	P.V.P. (€)
1 Litro	1	980008210	4002829155028	6,40
5 Litros	1	980008211	4002829155035	31,00

Aceite de cadena



Cantidad	Unds.	Código	EAN	P.V.P. (€)
1 Litro	1	988002256	4002829137390	4,70

Líquido limpieza cadena



Cantidad	Unds.	Código	EAN	P.V.P. (€)
500ml.	1	980008125	4002829441343	9,90



Correa para desbrozadoras



196335-6



7

- Arnés profesional, muy ergonómico, perfecto para las largas jornadas de trabajo.
- Reduce la tensión en la zona lumbar y en los hombros.
- Mejora la maniobrabilidad.
- Amplio protector lumbar que ayuda a que no se cargue la cadera.
- Arnés totalmente ajustable.

Modelos	Unds.	Código	EAN	P.V.P. (€)
Todos los modelos	1	196335-6	0088381423694	55,00
	1	196129-9	0088381442459	55,00



Modelos	Unds.	Código	EAN	P.V.P. (€)
Arnes para desbrozadoras en PDC1200	1	191E43-4	0088381556859	14,50



Modelos	Unds.	Código	EAN	P.V.P. (€)
Todos los modelos	1	122907-1	0088381426909	27,00

Modelos	Unds.	Código	EAN	P.V.P. (€)
Válido para desbrozadoras y batería de mochila PDC01.	1	197243-4	0088381454285	6,00

Protección



P-47363



P-47357

Descripción	Unds.	Código	EAN	P.V.P. (€)
Visera protectora transparente con goma	1	P-47363	0088381977791	11,00
Visera protectora metálica con goma	1	P-47357	0088381977784	9,10



988000606

Descripción	Unds.	Código	EAN	P.V.P. (€)
Casco con visera	1	988000606	-	75,00
Protectores auditivos	1	988000040	4002829215838	29,00

Accesorios para ahoyadora DDG460

Set mango ddg460



Descripción	Unds.	Código	EAN	P.V.P. (€)
Mango	1	191P11-3	0088381576994	153,00

Prolongador



Largo (mm)	Unds.	Código	EAN	P.V.P. (€)
540	1	E-07325	0088381572460	33,00

Cuchilla



Ø (mm)	Unds.	Código	EAN	P.V.P. (€)
50	1	E-13649	0088381592178	9,60
60	1	E-13655	0088381592185	10,20
80	1	E-13661	0088381592192	11,20
100	1	E-07630	0088381574518	12,00
150	1	E-07646	0088381574525	13,20
200	1	E-07652	0088381574532	15,50

Bulón para barrena



Descripción	Unds.	Código	EAN	P.V.P. (€)
Bulón	1	E-07331	0088381572477	3,40

Adaptadores



Descripción	Unds.	Código	EAN	P.V.P. (€)
Adaptadores	1	327685-0	-	39,00
	1	327684-2	0088381580175	33,00
	1	327687-6	0088381574471	29,00

Brocas para ahoyadora DDG460



Ø (mm)	Largo (mm)	Unds.	Código	EAN	P.V.P. (€)
50	800	1	E-13611	0088381592147	83,00
60	800	1	E-13627	0088381592154	91,00
80	800	1	E-13633	0088381592161	98,00
100	800	1	E-07294	0088381572439	107,00
150	800	1	E-07303	0088381572446	125,00
200	800	1	E-07319	0088381572453	148,00



Brocas para suelo 3/4"



Broca

Adaptador

Modelo	Descripción	Unds.	Código	EAN	P.V.P. (€)
DTW1001 TW001	Ø 20mm / 600 mm	1	B-54346	0088381477468	198,00
	Ø 25mm / 600 mm	1	B-54352	0088381477475	203,00
	Ø 30mm / 600 mm	1	B-54368	0088381477482	229,00
	Ø 35mm / 600 mm	1	B-54374	0088381477499	271,00
	Adaptador 3/4"	1	B-54380	0088381477505	50,00

Brocas para suelo para taladro



Modelo	Descripción	Unds.	Código	EAN	P.V.P. (€)
Inserción 13mm	Ø 30mm / 200 mm	1	D-75415	0088381595148	18,70
	Ø 45mm / 200 mm	1	D-75421	0088381595155	20,00
	Ø 70mm / 200 mm	1	D-75437	0088381595162	22,00
	Ø 100mm / 200 mm	1	D-75443	0088381595179	26,00
	Ø 130mm / 200 mm	1	D-75459	0088381595186	28,00

Accesorios para DUC122 y UC120D



Modelo	Descripción	Unds.	Código	EAN	P.V.P. (€)
DUC122	Extensión	1	195595-7	0088381398510	203,00
UC120D	Extensión 1,3 - 2,2 m.	1	192755-2	0088381146142	208,00



Modelo	Descripción	Unds.	Código	EAN	P.V.P. (€)
DUC122	Lima	1	953003090	4002829111703	2,30



Modelo	Descripción	Unds.	Código	EAN	P.V.P. (€)
DUC122	Aceite	1	199897-3	0088381582131	4,40

Destornillador de regulación



Descripción	Unds.	Código	EAN	P.V.P. (€)
Destornillador Philips n°2	1	783002-8	0088381102650	1,95
Regulación de carburador	1	783012-5	0088381417839	0,60



Cuchillas y accesorios para tijeras de poda



197367-6

197366-8

Modelo	Descripción	Unds.	Código	EAN	P.V.P. (€)
DUP361	Cuchilla fija	1	197367-6	0088381465373	47,00
	Cuchilla móvil	1	197366-8	0088381463720	54,00
DUP362	Cuchilla fija	1	199169-6	0088381526425	132,00
	Cuchilla móvil	1	199168-8	0088381526418	105,00



A-86664

B-05016

Modelo	Descripción	Unds.	Código	EAN	P.V.P. (€)
4604D	Cuchilla fija	1	A-86664	0088381150965	49,00
	Cuchilla móvil	1	B-05016	-	34,00

Arnés para tijera de poda DUP361 / 362



Descripción	Unds.	Código	EAN	P.V.P. (€)
Arnés para DUP361 y DUP362	1	161377-9	0088381473750	37,00

Lima de diamante y aceite



Modelo	Descripción	Unds.	Código	EAN	P.V.P. (€)
4604D DUP361 DUP362	Lima de diamante	1	794530-8	0088381116893	13,20
	Aceite	1	182470-6	0088381498135	1,50



NOVEDADES

Carretillas a batería DCU603 - DCU604 - DCU605



DCU603

Plataforma basculante + cuba basculante

- Gracias a su plástico impermeable se puede cargar con líquidos.
- El interior de la cubeta está diseñado para conseguir una fácil descarga.



Capacidad

- Sólidos: **200L**
- Líquidos: **100L**



DCU604

Plataforma basculante + plataforma de transporte

- Ideal para paquetes cerrados, sacos o bolsas.
- Alta eficiencia de descarga
- Plataforma telescópica

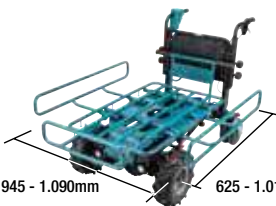

945 - 1.090mm 625 - 1.015mm



DCU605

Depósito

- Gracias a su plástico impermeable se puede cargar con líquidos.
- Diseñada para trabajos en los que no se requiera la descarga del material, como en alimentación de ganado, etc.



Posee un tapón en la parte inferior para descargar líquidos o limpiar la cubeta



18v + 18v → 36v

Capacidad para 4 baterías que son usadas de 2 en 2 para conseguir una autonomía de la herramienta extendida.



Faros de trabajo

- Encendido/Apagado pulsando el botón habilitado en la caja de batería.
- Apagado automático a los 10 minutos de inactividad.

Accesorios para carretillas DCU603, DCU604, DCU605 y DCU180

Plataformas



- Plataforma de carga con cuba de vaciado.

Descripción	Unds.	Código	EAN	P.V.P. (€)
Cuba basculante	1	191B69-8	-	1.150,00



- Plataforma de transporte en carretilla.
- Soporta una gran variedad de tamaños.

Descripción	Unds.	Código	EAN	P.V.P. (€)
Plataforma de transporte	1	191B67-2	-	645,00



- Incluye la plataforma basculante y su base.

Descripción	Unds.	Código	EAN	P.V.P. (€)
Depósito	1	1911B3-6	-	1.350,00



- Zona de volcado para la plataforma de transporte o la cuba basculante.

Descripción	Unds.	Código	EAN	P.V.P. (€)
Plataforma basculante	1	191B63-0	-	995,00

DCU603



DCU604



DCU605



Ruedas



- Para césped y acera.

Descripción	Unds.	Código	EAN	P.V.P. (€)
Neumático de 330mm	1	1911K4-7	-	115,00



- Para zonas industriales, como fábricas o naves donde no se desee dejar marcas de la rueda.

Descripción	Unds.	Código	EAN	P.V.P. (€)
Neumático gris de 330mm	1	1911K5-5	-	120,00



- Para zonas industriales, como fábricas o naves donde no se desee dejar marcas de la rueda.

Descripción	Unds.	Código	EAN	P.V.P. (€)
Neumático de 210mm	1	1911K6-3	-	83,00

Accesorios para DCU180



199008-0



199009-8



191A01-6

Descripción	Unds.	Código	EAN	P.V.P. (€)
Plataforma transporte	1	199009-8	0088381519632	224,00
Cubeta	1	199008-0	0088381519625	194,00
Set ruedas auxiliares	1	191A01-6	0088381545945	146,00



Hidrolimpiadoras



Pistolas



Lanza con boquilla



P-64917



Modelo	Material	Unds.	Código	EAN	P.V.P. (€)
HW102 HW111	Plástico	1	HW3320152	-	9,30
HW120	Metálica	1	HW41847		55,00
HW131RLW	Metálica	1	HW40925	8016287409254	51,00
HW132	Plástico	1	HW3640920	-	29,00
HW151	Metálica	1	HW41154	8016287411547	26,00
HW1200 HW1300 DHW080	Plástico	1	197842-2	0088381488990	24,00

Modelo	Tipo	Unds.	Código	EAN	P.V.P. (€)
HW102	Plana	1	HW3640640	-	3,70
HW102 HW111	Turbo	1	HW3320120	-	4,60
HW120	Plana	1	HW46221	-	28,00
HW131RLW	Plana	1	P-64901	0088381995429	41,00
HW131RLW	Turbo	1	P-64917	0088381995436	89,00
HW132	Plana	1	HW3641150	-	11,00
HW132	Turbo	1	HW3640940	-	11,30
HW151	Plana	1	HW40551	8016287405515	31,00
HW151	Turbo	1	HW40167	8016287401678	54,00
HW1200 HW1300 DHW080	Plana	1	197822-8	0088381484626	14,20
	Spray	1	197876-5	0088381496032	26,00
	Turbo	1	197824-4	0088381518383	14,70
	Turbo	1	191U88-8	0088381583855	37,00

Boquillas



Modelo	Descripción	Unds.	Código	EAN	P.V.P. (€)
HW120	Boquilla	1	HW3086	-	17,30
HW111 HW132	Boquilla	1	HW3640670	-	2,45
HW1200 HW1300	Boquilla abanico	1	191U86-2	0088381583848	27,00

Extensión



Modelo	Material	Unds.	Código	EAN	P.V.P. (€)
HW102 HW111	Plástico	1	HW3320130	-	4,60
HW1200 HW1300 DHW080	Plástico	1	197870-7	0088381484671	49,00
HW1200 HW1300	Plástico	1	198909-9	0088381497367	35,00



Manguera de alta presión



Modelo	Longitud	uds.	Código	EAN	P.V.P. (€)
HW102	5 m	1	HW3640630	-	11,60
HW111	5,5 m / 12 mm	1	HW3640660	-	47,00
HW120	10 m	1	HW3163270	-	171,00
HW131	15 m	1	HW2500390	-	182,00
HW132	8 m	1	HW3641570	-	63,00
HW151	10 m	1	HW3083550	-	80,00

Manguera desatascadora



Para la limpieza de tuberías.

Modelo	Longitud	Unds.	Código	EAN	P.V.P. (€)
HW102 HW111 HW132	8 m	1	P-64892	0088381995412	46,00
HW131 HW151	8 m	1	P-66503	0088381997034	51,00
HW102 HW111 HW132 HW151	10 m	1	HW41165	8016287411653	66,00
HW102 HW111 HW132 HW151	16 m	1	HW41167	8016287411677	105,00
HW1200 HW1300 DHW080	10 m	1	197837-5	0088381484657	27,00
	15 m	1	197840-6	0088381484664	33,00

Extensión de manguera de alta presión



Modelo	Longitud	Unds.	Código	EAN	P.V.P. (€)
HW102	5 m	1	HW41179	8016287411790	28,00
HW111 HW132	8 m	1	HW41181	8016287411813	75,00
HW1200 HW1300 DHW080	5 m	1	197845-6	0088381484688	30,00
	8 m	1	197847-2	0088381484695	41,00
	10 m	1	197850-3	0088381484701	48,00

Cepillos



*Es necesario adaptador HW3082750.

Modelo	Descripción	Unds.	Código	EAN	P.V.P. (€)
HW111 HW132 HW151* HW131RLW*	Triangular	1	HW3640950	-	6,40



Modelo	Descripción	Unds.	Código	EAN	P.V.P. (€)
HW102 HW111 HW132 HW151	Triangular	1	HW41185	8016287411851	19,30



*Es necesario adaptador HW3082750.

Modelo	Descripción	Unds.	Código	EAN	P.V.P. (€)
HW111 HW132 HW151* HW131RLW*	Rotativo	1	P-64858	0088381995375	22,00



*Es necesario adaptador HW3082750.

Modelo	Descripción	Unds.	Código	EAN	P.V.P. (€)
HW131RLW HW111 HW132 HW151	Para suelo sin depósito. Adaptador HW40542 incluido	1	HW41849	-	77,00



Modelo	Descripción	Unds.	Código	EAN	P.V.P. (€)
HW131RLW HW151	Rotativo	1	HW41187	8016287411875	33,00



Modelo	Descripción	Unds.	Código	EAN	P.V.P. (€)
HW1200 HW1300 DHW080	Rotativo	1	197831-7	0088381484640	17,30



Cepillos



Modelo	Descripción	Unds.	Código	EAN	P.V.P. (€)
HW1200 HW1300 DHW080	Cepillo triangular	1	197828-6	0088381489010	10,90



Modelo	Descripción	Unds.	Código	EAN	P.V.P. (€)
HW1200 HW1300 DHW080	Cepillo antisalpicadura	1	197864-2	0088381496001	25,00



HW41175



HW41163

Modelo	Descripción	Unds.	Código	EAN	P.V.P. (€)
HW102 HW111 HW132.	Cepillo para suelo mini.	1	HW41175	8016287411752	59,00
HW102 HW111 HW132 HW151	Kit de succión de agua	1	HW41163	8016287411639	60,00

Depósitos para detergente y detergente neutro



HW3640090



P-64864



197886-2

Modelo	Descrip.	Unds.	Código	EAN	P.V.P. (€)
HW102	Depósito detergente	1	HW3640090	-	3,50
Todos los modelos	Detergente neutro 1L	1	P-64864	0088381995382	18,70
	Aguja de limpieza de boquilla	1	197879-9	0088381496018	2,30
HW1200 HW1300 DHW080	Bote para detergente	1	197886-2	0088381489003	21,00

Adaptadores y filtros para hidrolimpiadoras



197883-8



HW3082750



197867-6



P-64870



75



197873-1



1910R2-4



1910R1-6

Modelo	Descripción	Unds.	Código	EAN	P.V.P. (€)
HW131RLW HW151 HW120	Adaptador	1	HW3082750	-	13,50
Todos los modelos	Conector tipo Gardena	1	P-64870	0088381995399	10,50
HW1200 HW1300 DHW080	Casquillo seguridad	1	197867-6	0088381490221	17,40
HW1200 HW1300 DHW080	Conector rápido	1	197883-8	0088381496049	6,50
HW1200 HW1300 DHW080	Adaptador	1	197853-7	0088381484749	9,00
HW1200 HW1300 DHW080	Kit de Manguera	1	197873-1	0088381484633	37,00
HW1200 HW1300 DHW080	Sed de filtros	1	1910R2-4	-	35,00
HW1200 HW1300 DHW080	Kit de Manguera	1	1910R1-6	-	24,50

Portaherramientas



Tecnologías:

STRAP/BELT SYSTEM

El sistema de correa con hebillas de liberación rápida en los extremos hace posible que pueda pasar fácilmente de un portaherramientas tipo bolsa a llevarlo en la cintura como un cinturón de herramientas ligero. Posibilidad de guardar más portaherramientas en el interior.



HEAVY-LOAD SUPPORT SYSTEM

El sistema de soporte de cargas pesadas proporciona una ayuda adicional para llevar un conjunto de herramientas, accesorios y portaherramientas súper pesados distribuyendo el peso entre la cintura y los hombros. Cómodo de llevar y reduce el cansancio durante la jornada laboral gracias a la amortiguación extragruesa de 20 mm.



TOOL LOOPS SYSTEM

El innovador sistema de alojamientos especiales para herramientas permite al usuario colocar diferentes herramientas o accesorios sin necesidad de ajustes. El material de alta calidad garantiza una gran durabilidad. La combinación de varios tamaños de estos alojamientos permite colocar fácilmente herramientas o accesorios de diferentes tamaños de la forma adecuada.



CS BACKPACK CARRYING SYSTEM

El sistema de transporte de mochila mantiene el portaherramientas en su lugar de forma segura a la espalda para tener libres totalmente las manos. Es ajustable, lo que reduce la fatiga de los hombros. Incluye un bloqueo deslizable para un ajuste rápido.



WATERPROOF BOTTOM

La base impermeable de alta calidad es una de las grandes ventajas de estos portaherramientas: rígida, resistente al desgaste e impermeable, mantiene las herramientas secas y protegidas de superficies húmedas y mojadas. La base de plástico reforzado también ayuda a mantener limpio el portaherramientas.



ANTI SLIP

El material antideslizante minimiza o incluso evita los accidentes por resbalones y caídas en el lugar de trabajo. La cinta de polipropileno de alta calidad tiene una superficie de goma que ayuda a mantener las herramientas en su lugar y proporciona protección extra que ayuda a prolongar la vida útil de los productos.



3 LAYERS

La tecnología de 3 capas es una combinación única de poliésteres y espumas que proporcionan una amortiguación y protección extra. Diseñadas para ser resistentes a la intemperie, estos paneles de polipropileno increíblemente ligeros están formados por tres capas unidas de forma segura. La característica innovadora de estos paneles está en la capacidad de colocarse dentro de cualquier espacio.





REAL LEATHER

El cuero es suave por fuera y cepillado por dentro. Fuerte y resistente para una larga vida útil, pero lo suficientemente suave y flexible para una gran comodidad, al tiempo que proporciona una excelente resistencia, especialmente a los roces. Se ha elegido el cuero para la fabricación de productos que requieren de una capa más gruesa (de 1,8 a 2,0 mm), lo que garantiza la máxima calidad.



DURABLE RIVETING

El remache duradero proporciona una resistencia realmente irrompible. Resistentes remaches autoperforantes de una pieza con arandelas que se utilizan en todas las zonas con alta tensión. Se utilizan arandelas para una mayor resistencia en uno o ambos lados de lugares estratégicos, hacia arriba y hacia abajo.



LOOP-CLIP SOLUTION

La sujeción con mosquetón al cinturón es un sistema innovador gracias al cual, cada bolsa se puede sujetar de manera fácil pero segura a su cinturón. El exclusivo sistema de bloqueo protege la herramienta o el accesorio de caídas. Enganchar tus herramientas nunca ha sido tan fácil.



ELASTIC LOOPS

Los alojamientos elásticos especiales aseguran y mantienen las herramientas en su lugar durante el transporte. Proporciona una gran flexibilidad a la hora de organizar herramientas y accesorios. Existen en una amplia variedad de nuestros productos para garantizar el máximo uso de los mismos. Los alojamientos son capaces de adaptarse perfectamente a todas las herramientas y accesorios.



SIDE-GATE SOLUTION

El soporte lateral permite colocar fácilmente la herramienta sin mirar el portaherramientas. Una función de giro adicional garantiza que la herramienta se mantenga en un ángulo cómodo. Fabricado con acero inoxidable para una mayor longevidad del producto y fijado con cuatro remaches para mayor resistencia.



BELT LOOP HOLDER

La correa con presilla de sujeción es resistente y posibilita colgar cualquier cosa con un mosquetón. Mantiene la herramienta o el accesorio seguro, lo que permite que un bolsillo quede libre. La presilla para cinturón se desliza sobre el cinturón y permanece enganchada de forma segura.



RAIL GUIDE SYSTEM

El sistema de guía de carril es un sistema de organización extremadamente versátil. Una combinación perfecta de guías laterales de plástico y separadores que permite la personalización de compartimentos individuales. Los separadores están hechos de paneles de núcleo estructural de 3 capas. Cada separador se puede mover a lo largo de carriles ubicados en las paredes laterales.



Sistema de correa

STRAP

Función de correa

Totalmente nuevo en el mercado: el exclusivo sistema de cinturón / correa con hebillas de liberación rápida en los extremos hace que sea muy polivalente. Usándolo con una cómoda hombrera de goma suave hace que el levantamiento del portaherramientas sea más cómodo. Se adapta a todos los portaherramientas Makita.

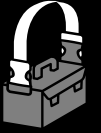

E-15431
Portaherramientas cerrado



E-15453
Organizador con cuatro bolsas



E-15512
Bolsa para sierra de cadena



E-05670
Funda para guía de carril 1m



E-05664
Funda para guía de carril 1,4m / 1,5m



E-15394
Maletín portaherramientas reforzado



E-15403
Portaherramientas abierto con asa



E-15584
Nevera con correa



Más de **20** productos con este sistema



E-15263
Portaobjetos



E-05197
Portaclavos con sujeción de martillo



E-15154
Cartuchera grande universal



STRAP BELT SYSTEM



BELT



Función de cinturón.
 La correa se puede quitar fácilmente de cualquier portaherramientas y llevarse a la cintura como un cinturón de herramientas de uso ligero.
 La correa se puede ajustar, lo que es flexible y conveniente para adaptarse a sus necesidades. Se puede usar con cualquier portaherramientas Makita.



E-15556
 Funda para móvil vertical



E-05309*
 Set de correa con presilla (3 unds)
E-05315*
 Set de correa con presilla (6 unds)

E-15279
 Portaherramientas electricista



E-15300
 Portamartillo



E-15291
 Portamartillo con cierre



E-15322
 Portatijera de poda



E-15350
 Cinturón / Asa



E-15241
 Bolsa para electricista



E-15198
 Bolsa multusos doble

E-15182
 Bolsa con cartuchera

E-15176
 Cartuchera pequeña



E-15213
 Bolsa para carpintero



E-15207
 Organizador con tres bolsas

* Consultar disponibilidad





Iconos:

Materiales:

- Poliéster 600D**
- Poliéster 1680D**
- Cuero de alta calidad**
- Material de goma**
- Malla**
- Material antideslizante**
- Malla transpirable**
- Material triplex**
- Poliétileno de alta densidad**
- Lámina aislante térmica**
- Correas ajustables**
- Gancho y mosquetón**
- Banda elástica**
- Cinta de polipropileno**
- Cremallera**

Herrajes y accesorios:

- Asa de plástico**
- Asa de goma**
- Asa de metal**
- Mango de cinta de polipropileno con almohadilla**
- Mosquetón de aluminio**
- Mosquetón**
- Base metálica**
- Botón de presión**
- Ollaos**
- Remache**
- Cinturón de doble agujero**
- Tirador**
- Regulador**
- Ajuste de cinta**
- Cierre de cinturón**
- Pinza de liberación rápida**
- Hebilla de liberación rápida**
- Correa para el hombro acolchada**
- Correa con almohadilla de goma**
- Marco de aluminio**
- Equipaje de mano**
- Portapuntas**
- Lateral portamartillos**
- Portamartillos deslizante**
- Portamartillos fijo**
- Cinta aislante para cadena**
- Clip para cinta métrica**
- Bolsillo para smartphone**
- Bolsillo para ordenador portátil**
- Bolsillo para documentos**
- Alojamiento para tarjetas de visita**
- Alojamiento para bolígrafos**
- Alojamiento para cutter**
- Alojamiento para destornillador**
- Alojamiento para brocas**
- Alojamiento para lijas manuales**
- Alojamiento para tenazas**
- Alojamiento para mosquetón**



Cinturón / Correa de cierre rápido

- La solución única como cinturón de herramientas de uso ligero.
- Se adapta a todas las bolsas y portaherramientas, además de a los estuches de herramientas.
- Este cinturón básico es perfecto para diversas actividades laborales y cuenta con hebilla de liberación rápida.
- Sirve como base para construir tu propio juego de cinturón personalizado con las herramientas que te sean necesarias.

STRAP / BELT
SYSTEM



La solución única para usar como cinturón de herramientas manuales.

Medidas (L x An x Al)	Peso (Kg)	Capacidad (L)	Unds.	Código	EAN	P.V.P (€)
1300 x - x 38 mm	0,18	-	1	E-15350	0088381598538	12,70

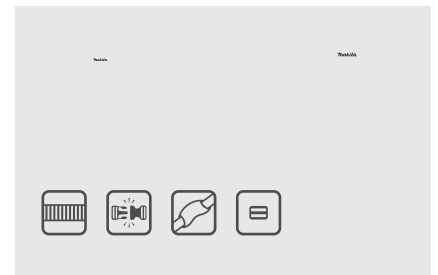

- 1 Hebilla de polipropileno de 40mm.
- 2 Hombreira con diseño ergonómico.
- 3 Regulador de longitud.
- 4 Correa de alta resistencia en azul Makita.



Hebilla de cierre rápido.



Instrucciones de uso simplificadas.



Make It Right, Make It Makita

TECNOLOGÍAS

STRAP / BELT SYSTEM

ANTI SLIP

3 LAYERS

ELASTIC LOOPS

3D SHAPED POUCHES

SIDE-GATE SOLUTION

BELT LOOP HOLDER

DURABLE RIVETING

REAL LEATHER



Cartuchera grande universal

- 2 alojamientos elásticos a los lados.
- 2 alojamientos para brocas de cuero auténtico.
- Libera las manos para moverse con seguridad en escaleras, techos y andamios.
- Portaherramientas equilibrado: sostiene la mayoría de taladros de todas las marcas.
- Herramientas accesibles, una única posible posición para un mejor equilibrio.
- Hecho de poliéster 1680D, resistente para mayor durabilidad.



Cinta de cuero auténtico con botón de presión que sujeta con seguridad el taladro al subir o bajar de escaleras

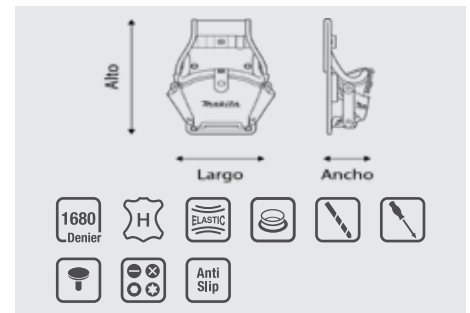

- 1 Los remaches y arandelas de níquel para mayor resistencia y un uso duradero.
- 2 Alojamiento para brocas hecho de cuero auténtico para un práctico y sencillo almacenamiento.
- 3 Los alojamientos laterales para diversas herramientas y accesorios ofrecen muchas opciones.
- 4 Cinta antideslizante con superficie de goma en la parte superior para evitar accidentes por resbalones y caídas en el lugar de trabajo.
- 5 Alojamientos elásticos para brocas proporcionan un almacenamiento conveniente.
- 6 Botones de presión de acero para inmovilizar la correa de seguridad cuando se usa el taladro.
- 7 Los dos botones de presión hacen que la funda sea universal para usar con máquinas de diferentes tamaños.

Medidas (L x An x Al)	Peso (Kg)	Capacidad (L)	Unds.	Código	EAN	P.V.P (€)
170 X 85 X 290 mm	0,3	-	1	E-15154	0088381598330	30,00



Muy cómodos para zurdos y diestros.

Herramientas no incluidas



Cartuchera pequeña

- Fabricado para ser duradero y a su vez ligero.
- Se puede usar en cualquier cinturón de herramientas Makita o cinturón de ropa normal.
- Fácil de manejar con una mano.
- 2 alojamientos elásticos especiales para una mayor organización.
- 2 alojamientos especiales para brocas y un alojamiento abierto para el adaptador de cambio rápido.
- Libera las manos para moverse con seguridad en escaleras, techos y andamios.

STRAP/BELT SYSTEM

ANTI SLIP

3 LAYERS

3D SHAPED POUCHES

REAL LEATHER

DURABLE RIVETING

ELASTIC LOOPS



Cinta de cuero auténtico con botón de presión que sujeta con seguridad el taladro al subir o bajar de escaleras

Medidas (L x An x Al)	Peso (Kg)	Capacidad (L)	Unds.	Código	EAN	P.V.P (€)
155 x 75 x 235 mm	0,13	-	1	E-15176	0088381598354	22,00

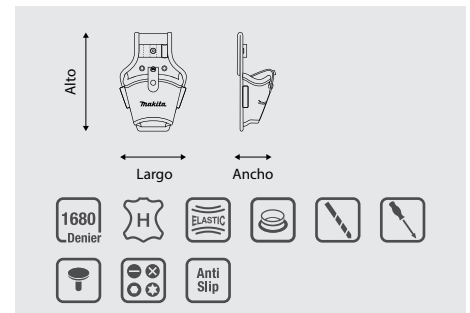

- 1 Los alojamientos elásticos para brocas ofrecen un práctico almacenamiento.
- 2 Botones de presión de acero inoxidable.
- 3 Alojamiento elástico especial para adaptador de cambio rápido. Su construcción abierta aporta mayor comodidad.
- 4 Cinta antideslizante con superficie de goma en la parte superior para evitar accidentes por resbalones y caídas en el lugar de trabajo.
- 5 Los remaches y arandelas niquelados aportan mayor resistencia y una vida útil más larga.
- 6 Botones de presión de acero inoxidable para inmovilizar la correa de seguridad cuando se usa con un taladro.
- 7 Los alojamientos laterales para diversas herramientas y accesorios ofrecen una amplia variedad de posibilidades.
- 8 Elegante diseño de malla Makita.



Muy cómodos para zurdos y diestros.

Herramientas no incluidas

Bolsa con cartuchera

- Seguro, práctico y cómodo. Todo en uno.
- 4 alojamientos de cuero auténtico.
- 6 alojamientos elásticos para una perfecta organización.
- Cuenta con una bolsa grande y profunda para herramientas.
- Interior forrado de poliéster resistente que resiste años de desgaste.
- Mantiene herramientas accesibles cuando se necesitan. ¡Solo cógelas y a trabajar!



STRAP/BELT SYSTEM

ANTI SLIP

3 LAYERS

3D SHAPED POUCHES

REAL LEATHER

DURABLE RIVETING

ELASTIC LOOPS



Diseño de malla elegante Makita en el frente del portaherramientas rodeado de alojamientos de cuero

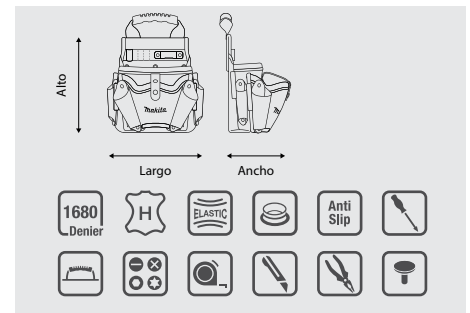

- 1 Correas antideslizantes con superficie de goma en la parte superior.
- 2 Portacutter de cuero auténtico.
- 3 Los dos botones de presión de metal hacen que la funda sea más versátil para usar máquinas de diferentes tamaños.
- 4 Su asa ergonómica antideslizante proporciona un transporte más cómodo.
- 5 Los alojamientos elásticos para puntas brindan un práctico almacenamiento.
- 6 Cinta con botones de presión fabricada en acero inoxidable.
- 7 Alojamientos elásticos para herramientas y sus accesorios más esenciales.
- 8 El alojamiento para destornilladores hecho de cuero auténtico proporciona un práctico almacenamiento en el interior.

Medidas (L x An x Al)	Peso (Kg)	Capacidad (L)	Unds.	Código	EAN	P.V.P (€)
260 x 145 x 270 mm	0,55	1,5	1	E-15182	0088381598361	59,00



Alojamientos elásticos en el interior.

Herramientas no incluidas

Bolsa multiusos doble

- Perfecto portaherramientas para empezar junto con el cinturón de herramientas.
- 2 bolsillos grandes para llevar todas las herramientas y accesorios necesarios.
- 3 alojamientos de cuero auténtico.
- 4 alojamientos elásticos para herramientas.
- La presilla para colgar varias herramientas y accesorios permite un almacenamiento rápido.
- Forro interior de poliéster duradero para resistir los años de desgaste.



La presilla para colgar varias herramientas y accesorios proporciona un almacenamiento fácil y rápido.

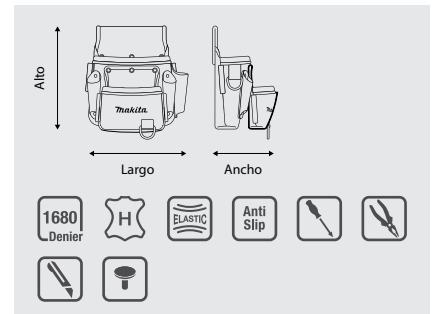

- 1 Portadestornillador de cuero auténtico.
- 2 Ancho alojamiento de cuero auténtico para cutter.
- 3 El bolsillo frontal tiene muchas posibilidades y además, proporciona una identificación rápida de las herramientas.
- 4 Presilla para colgar diversas herramientas y accesorios.
- 5 Banda elástica especial para destornilladores y otras herramientas pequeñas.
- 6 Correas antideslizantes con superficie de goma.
- 7 Bolsillo principal con cincha antideslizante.
- 8 El remache extra de la bolsa proporciona una vida útil más duradera.

Medidas (L x An x Al)	Peso (Kg)	Capacidad (L)	Unds.	Código	EAN	P.V.P (€)
290 x 145 x 270 mm	0,66	2,9	1	E-15198	0088381598378	41,00



Portaherramientas elásticos en el interior

Herramientas no incluidas

Bolsa para electricistas

- Diseñado para cumplir con las necesidades del electricista profesional.
- 12 alojamientos elásticos en la parte delantera.
- 8 cintas antideslizantes.
- 3 trabillas elásticas en los lados.
- 2 bolsillos grandes principales.
- 1 alojamiento de cuero y 2 soportes de poliéster a los lados.

STRAP/BELT SYSTEM

ANTI SLIP

3 LAYERS

3D SHAPED POUCHES

REAL LEATHER

DURABLE RIVETING

ELASTIC LOOPS



Los alojamientos elásticos extra dentro del portaherramientas mantienen sus herramientas seguras, bien organizadas y en su sitio.

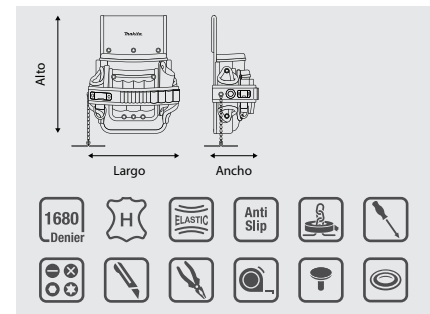

Medidas (L x An x Al)	Peso (Kg)	Capacidad (L)	Unds.	Código	EAN	P.V.P (€)
250 x 125 x 310 mm	0,55	1,70	1	E-15241	0088381598422	43,00

- 1 Cintas antideslizantes con superficie de goma en la parte superior.
- 2 Alojamiento de cuero auténtico especial para cutter.
- 3 Alojamiento elástico para destornilladores.
- 4 Portacinta métrica de acero inoxidable
- 5 Posibilidad de colgar un mosquetón en la presilla.
- 6 Gancho en forma de T.
- 7 Alojamiento elástico externo fuera del bolsillo principal.
- 8 Alojamiento para herramientas fabricados con poliéster de caucho resistente.
- 9 Bolsillo frontal para cualquier tipo de herramientas de electricista.
- 10 Alojamiento lateral adicional hecho de material de 3 capas.



Bolsillo principal para guardar herramientas de electricista

Herramientas no incluidas



Organizador con 3 bolsas

- 3 bolsillos espaciosos para una variedad de herramientas y accesorios.
- 2 alojamientos de cuero auténtico.
- Transportatodo: clavos, piezas, herramientas, tornillos, lápices, etc.
- Capaz de manejarse con una mano.
- Todas las herramientas necesarias al alcance de la mano.
- Contiene múltiples bolsillos y alojamientos para una perfecta organización.



STRAP/BELT SYSTEM

ANTI SLIP

3 LAYERS

3D SHAPED POUCHES

REAL LEATHER

DURABLE RIVETING

ELASTIC LOOPS



Los alojamientos extra dentro de la bolsa ubicados en la pared trasera mantienen sus herramientas sujetas y seguras.

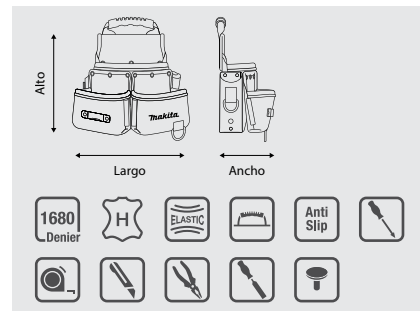

Medidas (L x An x Al)	Peso (Kg)	Capacidad (L)	Unds.	Código	EAN	P.V.P (€)
320 x 145 x 270 mm	0,67	3,3	1	E-15207	0088381598385	52,00



- 1 El portacincel, hecho de cuero auténtico, extra remachado, protege la herramienta correctamente.
- 2 La presilla para colgar varias herramientas y accesorios proporciona un almacenamiento extra, fácil y rápido.
- 3 Su asa ergonómica con cinta antideslizante proporciona un transporte cómodo.
- 4 El alojamiento de acero inoxidable para la cinta métrica sostiene cualquier cinta estándar de 3 a 10 m.
- 5 Alojamientos elásticos laterales para tener todas las herramientas y accesorios esenciales al alcance de la mano.
- 6 Remachas duraderos con arandelas para mayor resistencia.
- 7 Las correas antideslizantes con superficie de goma en la parte superior evitan accidentes por resbalones y caídas en el lugar de trabajo.
- 8 El organizador se coloca cómodamente en cualquier cinturón de herramientas Makita o cinturón de ropa normal.
- 9 Logotipo de Makita visible, moderno diseño de malla Makita.
- 10 El bolsillo frontal tiene muchas posibilidades y además, proporciona una identificación rápida de la herramienta o el accesorio.

Herramientas no incluidas

Bolsa para carpintero

- Bolsa grande ideal para carpinteros, jardineros y/o todo personal de mantenimiento.
- Organice cuidadosamente una variedad de herramientas manuales y evite que se caigan.
- Se puede usar con cualquier herramienta.
- 3 alojamientos de cuero a los lados.
- 3 alojamientos elásticos azules.
- 2 presillas para colgar cualquier cosa con un mosquetón.

STRAP/BELT SYSTEM

ANTI SLIP

3 LAYERS

3D SHAPED POUCHES

REAL LEATHER

DURABLE RIVETING

ELASTIC LOOPS



El portamartillo de acero inoxidable del lateral se balancea para mantener siempre el martillo en posición vertical.

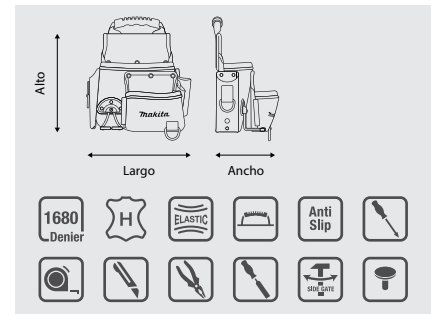

- 1 Alojamiento para destornillador de cuero auténtico.
- 2 Portacuchillos de cuero auténtico.
- 3 El bolsillo frontal ofrece muchas posibilidades y proporciona una identificación rápida de las herramientas.
- 4 Presilla para colgar varias herramientas y accesorios.
- 5 El portamartillo de acero inoxidable del lateral se balancea para mantener siempre el martillo en posición vertical.
- 6 Portacinceles, hecho de cuero auténtico, extraremachado, protege la herramienta correctamente.
- 7 Alojamientos elásticos para herramientas a los lados para tener todos los elementos esenciales a mano.
- 8 El asa ergonómica facilita el transporte.

Medidas (L x An x Al)	Peso (Kg)	Capacidad (L)	Unds.	Código	EAN	P.V.P (€)
290 x 145 x 270 mm	0,66	2,60	1	E-15213	0088381598392	59,00



Alojamientos elásticos extra dentro del portaherramientas

Portabolsas con correa

- Mantiene herramientas y accesorios al alcance de la mano, ¡solo en la cintura!
- 5 bolsillos espaciosos.
- 6 alojamientos de cuero con una resistencia y durabilidad fiables.
- 2 presillas para la correa incluidos.
- 10 alojamientos elásticos para un fácil acceso a las herramientas y destornilladores adicionales fuera de los bolsillos.



ANTI SLIP

3 LAYERS

3D SHAPED POUCHES

REAL LEATHER

DURABLE RIVETING

ELASTIC LOOPS

SIDE-GATE SOLUTION

BELT LOOP HOLDER



Dos bolsillos principales profundos para un almacenamiento seguro de las herramientas, 2 bolsillos delanteros y un bolsillo más pequeño en el medio.

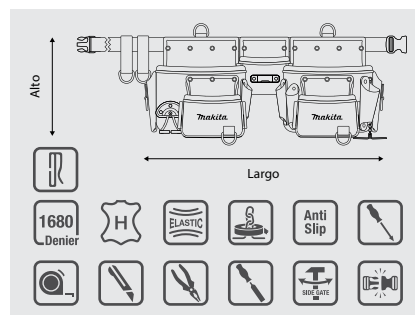

Medidas (L x An x Al)	Peso (Kg)	Capacidad (L)	Unds.	Código	EAN	P.V.P (€)
640 x 145 x 270 mm	1,34	6,50	1	E-15229	0088381598408	121,00



Herramientas no incluidas

Tres bolsas Cinco bolsillos Treinta alojamientos

- 1 Presilla en el extremo del cinturón para evitar que se caiga.
- 2 2 presillas para cinturón incluidos.
- 3 Presilla para colgar varias herramientas y accesorios.
- 4 Portacincel, hecho de cuero auténtico.
- 5 Presilla adicional para usar con mosquetón.
- 6 Portamartillo de acero inoxidable.
- 7 Alojamientos elásticos en el interior de los bolsillos principales.
- 8 Presillas.
- 9 2 presillas para colgar cualquier útil con mosquetón.
- 10 Portadestornillador de cuero auténtico.
- 11 Construcción robusta con varios remachaes adicionales.
- 12 Portacinta métrica de acero inoxidable.
- 13 Portaherramientas de cuero.
- 14 Alojamiento especial para destornilladores.
- 15 Bolsillo frontal de muchas posibilidades y herramientas más pequeñas.
- 16 Alojamientos elásticos especiales dentro del bolsillo principal.
- 17 Correas antideslizantes con superficie de goma en la parte superior.
- 18 Portacutter de cuero auténtico.
- 19 Gancho en forma de T
- 20 Gancho en forma de hebilla de 40 mm de liberación rápida.



Cinturón completo

- Distribuye el peso de las herramientas de manera uniforme alrededor de la cintura para mayor comodidad durante el día.
- Totalmente personalizable. Se puede cargar con varios tipos de portaherramientas.
- Conjunto de cinturón extra cómodo para trabajos pesados con todo el equipo necesario alrededor de la cintura.
- Capaz de guardar todo: repuestos, herramientas, brocas, lápices, etc. (accesorios y herramientas no incluidos).
- Acolchado de malla transpirable para el calor y el frío.



STRAP/BELT SYSTEM

ANTI SLIP

3 LAYERS

3D SHAPED POUCHES

REAL LEATHER

DURABLE RIVETING

ELASTIC LOOPS

BELT LOOP HOLDER



2 bolsillos principales de gran tamaño para el almacenamiento seguro de las herramientas, 2 bolsillos delanteros de amplias posibilidades y un bolsillo más pequeño en el medio.

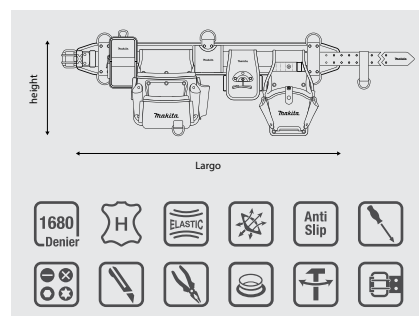

Medidas (L x An x Al)	Peso (Kg)	Capacidad (L)	Unds.	Código	EAN	P.V.P (€)
310 x - x 880 mm	1,73	2,78	1	E-15235	0088381598415	149,00



Soporte para teléfono móvil con bolsillos elásticos delanteros.

Cuarenta alojamientos y diversos bolsillos



Logo visible Makita en el portaherramientas.

- 1 Hebilla de cinturón con doble pasador para mayor resistencia y seguridad.
- 2 Trabilla de cinturón Makita.
- 3 Trabilla de cinturón de cuero.
- 4 Presilla para enganchar tirantes.
- 5 Útil presilla para colgar cualquier útil con mosquetón.
- 6 Cierre con cremallera.
- 7 Bolsillo principal plano elástico en color azul Makita.
- 8 Bolsillo plano extra elástico en la parte delantera del cinturón.
- 9 Alojamiento elásticos laterales para herramientas pequeñas.
- 10 Presilla para colgar varias herramientas y accesorios.
- 11 Bolsillo principal grande para el almacenamiento seguro de todas sus herramientas principales.
- 12 Bolsillo frontal para las herramientas más pequeñas.
- 13 Cinta antideslizantes con superficie de goma en la parte superior.
- 14 Presilla adicional.
- 15 Alojamiento especial para destornillador de cuero auténtico.
- 16 Alojamiento especial para cutter de cuero auténtico.
- 17 Logotipo de Makita claramente visible en la parte posterior.
- 18 Alojamiento elástico especial para destornilladores.
- 19 Soporte de martillo resistente forjado en acero inoxidable.
- 20 Portamartillo con capacidad de balanceo para mantenerse siempre en posición vertical.
- 21 Mezcla de cuero y cinta de polipropileno resistente.
- 22 Alojamiento para destornillador de cuero auténtico.
- 23 Alojamiento elástico para brocas en color Makita.
- 24 Botón de presión adicional para inmovilizar la correa.
- 25 Alojamiento elástico para adaptador de cambio rápido.
- 26 Botones de presión para enganchar y desenganchar rápidamente.
- 27 Cintas antideslizantes con superficie de goma en la parte superior.
- 28 Construcción robusta con remaches de refuerzo.
- 29 Trabilla de 2 capas.
- 30 La parte principal del cinturón está hecha de cuero de alta calidad.
- 31 Cinta con presilla incluida adicionalmente en el cinturón.
- 32 Doble hilera de orificios para mayor resistencia y seguridad.
- 33 Logotipo visible de Makita grabado en el cinturón.



- Bolsillo principal grande para guardar de forma segura sus herramientas y accesorios.
- Alojamiento especial de cuero auténtico para cutter.
- Remaches para una resistencia y durabilidad verdaderamente irrompibles.
- Bolsillo frontal para fijaciones y herramientas más pequeñas.

- Hecho de poliéster resistente de 1680D.
- Fuertes costuras industriales para mayor durabilidad.
- Correas antideslizantes con superficie de goma en la parte superior del cinturón.
- Numerosos alojamientos elásticos para brocas y adaptadores de brocas.
- Dos botones de presión de metal lo hacen más versátil.



Cinta de cuero auténtico con botón de presión metálico.



Portaherramientas correctamente ubicado en un lateral.

Portaclavos con portamartillo

- Para cualquier tipo de trabajo: constructores, carpinteros, mecánicos, electricistas, trabajadores, etc.
- Se adapta cómodamente a cualquier cinturón Makita.
- Transporta todo: clavos, piezas, herramientas, tornillos, lápices, etc.
- Cómodo de llevar, mantiene las herramientas al alcance de la mano.
- Un buen inicio para empezar tu juego de portaherramientas Makita.



STRAP/BELT SYSTEM

ANTI SLIP

3 LAYERS

3D SHAPED POUCHES

REAL LEATHER

DURABLE RIVETING

ELASTIC LOOPS



Los alojamientos elásticos mantienen las herramientas seguras y fijas.

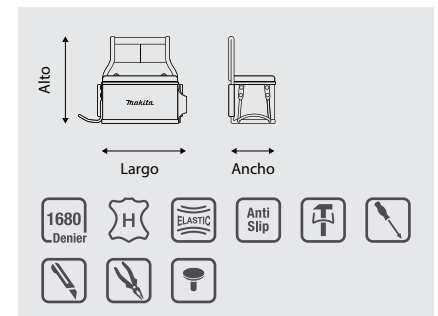

Medidas (L x An x Al)	Peso (Kg)	Capacidad (L)	Unds.	Código	EAN	P.V.P (€)
180 x 105 x 185 mm	0,25	1,25	1	E-15257	0088381598439	27,00

- 1 Cintas antideslizantes con superficie de goma en la parte superior.
- 2 Alojamiento elástico para herramientas más pequeñas.
- 3 Bolsillo principal muy versátil.
- 4 Portamartillo de acero inoxidable.
- 5 Alojamiento de cuero diseñado para pinzas.



También para jardín

Portaclavos con portamartillo

Herramientas no incluidas

Portaobjetos con cremallera

- Libera las manos para que pueda moverse con seguridad en escaleras, techos y andamios.
- Portaobjetos perfecto para diversas actividades laborales.
- Se adapta cómodamente a cualquier cinturón Makita.
- Mantiene sus herramientas a mano cuando se necesitan.
- Seguro, práctico y cómodo.
- Espacio para clavos, piezas, herramientas, juegos de clavos, lápices, etc.

STRAP BELT SYSTEM

3 LAYERS

3D SHAPED POUCHES

DURABLE RIVETING

ELASTIC LOOPS



Portacinta métrica de acero inoxidable para cualquier cinta métrica estándar de 3 a 10 m. La solución perfecta para tus baterías.

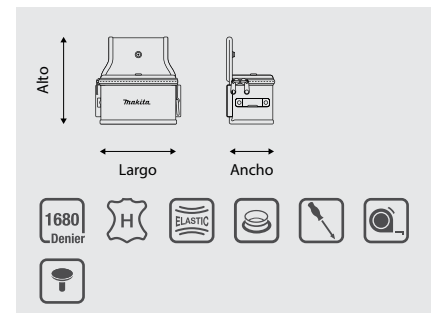

Medidas (L x An x Al)	Peso (Kg)	Capacidad (L)	Unds.	Código	EAN	P.V.P (€)
175 x 105 x 185 mm	0,24	1,0	1	E-15263	0088381598446	27,00

- 1 Con cremallera para un almacenamiento seguro, antipolvo.
- 2 Botones de presión.
- 3 El bolsillo principal tiene capacidad para dos baterías.
- 4 Presilla para colgar cualquier cosa con enganche de mosquetón.
- 5 Alojamiento especiales adicionales para destornilladores.



Portaobjetos con alojamientos elásticos

Herramientas no incluidas

Portaherramientas especial electricista

- Se puede llevar de 4 formas diferentes, incluido en el cinturón.
- Alojamiento seguro en cualquier posición de trabajo.
- 5 alojamientos elásticos para herramientas en la parte delantera para un almacenamiento práctico.
- 2 alojamientos de cuero para mayor resistencia.
- 2 alojamientos de poliéster en los lados para una mejor organización.



STRAP/BELT SYSTEM

REAL LEATHER

DURABLE RIVETING

ELASTIC LOOPS



Los alojamientos elásticos mantienen las herramientas seguras y en su lugar inmovilizando las herramientas más largas.

Medidas (L x An x Al)	Peso (Kg)	Capacidad (L)	Unds.	Código	EAN	P.V.P (€)
185 x 55 x 205 mm	0,28	-	1	E-15279	0088381598453	27,00

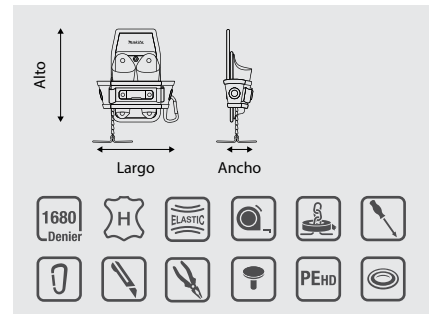

- 1 Tornillo regulador de la intensidad ocasionada por el balanceo.
- 2 Portacinta métrica de acero inoxidable.
- 3 2 alojamientos elásticos laterales para herramientas.
- 4 2 alojamientos laterales versátiles que sujetan de forma segura las herramientas más grandes y pesadas.
- 5 Mosquetón negro para enganchar cualquier tipo de objeto.
- 6 2 alojamientos de cuero versátiles para una organización segura de las herramientas más grandes.
- 7 El gancho en forma de T.
- 8 Reverso reforzado para mayor ergonomía.



Tornillo para regular la intensidad del balanceo

Herramientas no incluidas

Portaherramientas completamente giratorio. 4 modos de ajuste



Balaceo para mantener las herramientas siempre en posición vertical

- Reverso de polipropileno para mantener la rigidez y la forma óptima deseada.
- Alojamiento elástico lateral para tener todas las herramientas y accesorios a mano.
- El portacinta métrica sostiene cualquier cinta estándar de 3 a 10 m.



Portamartillo

- El soporte de acero inoxidable se adapta a cualquier martillo.
- 2 alojamientos elásticos adicionales para lápiz o destornillador.
- Se adapta a cualquier cinturón Makita.
- Hecho de poliéster duradero para soportar años de desgaste.
- Portaherramientas básico perfecto para diversas actividades laborales.
- Makita: la marca más reconocida en productos de ropa de trabajo.



STRAP BELT SYSTEM

3 LAYERS

DURABLE RIVETING

ELASTIC LOOPS

SIDE-GATE SOLUTION



El soporte del martillo de acero inoxidable de se balancea para mantener el martillo siempre en posición vertical.

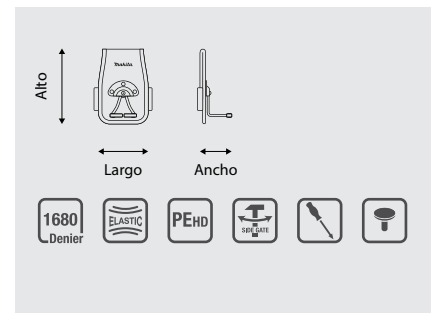

- 1 Soporte del martillo de acero inoxidable.
- 2 Polipropileno para mantener la rigidez.
- 3 Alojamientos elásticos para todos accesorios esenciales.
- 4 Cinturón de hasta 50 mm de ancho.
- 5 Balanceable para mantener el martillo siempre en posición vertical.

Medidas (L x An x Al)	Peso (Kg)	Capacidad (L)	Unds.	Código	EAN	P.V.P (€)
880 x 30 x 100 mm	0,66	-	1	E-15291	0088381598477	16,50



Compatible con todos los tipos de martillos de construcción.

Herramientas no incluidas

Portamartillos con cierre

- Portaherramientas de acero inoxidable para martillos o hachas.
- 2 alojamientos elásticos laterales.
- Seguro, práctico y cómodo.
- Mantiene las herramientas al alcance de la mano.
- Se adapta perfectamente a cualquier cinturón Makita.
- Hecho de poliéster duradero para resistir los años de desgaste.

STRAP BELT SYSTEM

3 LAYERS

DURABLE RIVETING

ELASTIC LOOPS



Sostiene todo tipo de martillos para obreros, carpinteros y personal de construcción.

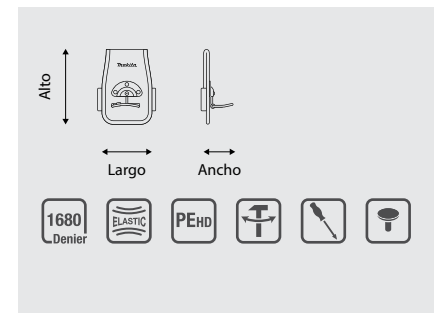

Medidas (L x An x Al)	Peso (Kg)	Capacidad (L)	Unds.	Código	EAN	P.V.P (€)
110 x 70 x 165 mm	0,15	-	1	E-15300	0088381598484	15,40

- 1 Portaherramientas de acero inoxidable para martillos.
- 2 Capaz de balancearse para que el martillo siempre quede en posición vertical.
- 3 Alojamiento elástico para todos los accesorios esenciales.
- 4 Las presillas se ajustan a un cinturón de hasta 50 mm de ancho.
- 5 Reverso de polipropileno para mantener la forma original.



Herramientas no incluidas



También para jardín

También puedes usar este portaherramientas en exteriores.



Portaflexómetro

- Portaflexómetro ajustable y fácil de usar.
- Especialmente diseñado con agujeros para medir sin sacar la cinta.
- 2 alojamientos elásticos para lápices, destornilladores y otros accesorios más pequeños.
- Hecho de poliéster duradero para resistir los años de desgaste.
- Construido para ser duradero pero ligero a su vez.
- Se puede usar en cualquier cinturón de herramientas Makita o cinturón de ropa normal.
- Se puede utilizar para cintas métricas de 3 a 10 m.

STRAP/BELT SYSTEM

ANTI SLIP

3 LAYERS

3D SHAPED POUCHES

DURABLE RIVETING

ELASTIC LOOPS



Cinta antideslizante con superficie de goma en la parte superior para evitar accidentes por resbalones y caídas en el lugar de trabajo.

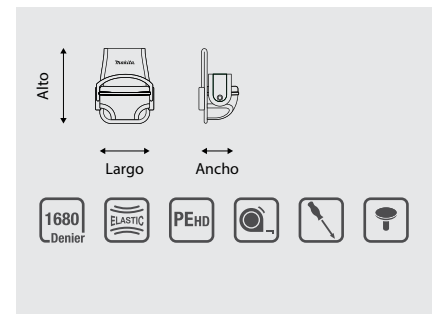

Medidas (L x An x Al)	Peso (Kg)	Capacidad (L)	Unds.	Código	EAN	P.V.P (€)
110 x 80 x 165 mm	0,14	-	1	E-15338	0088381598514	13,20



- 1 Alojamiento elástico especial para destornilladores y otras herramientas pequeñas.
- 2 Cierre para móviles abrochado con dos remaches laterales.
- 3 Solapa para asegurar la cinta métrica con opción de movimiento tanto hacia arriba como hacia abajo.
- 4 Cintas antideslizantes con superficie de goma en la parte superior
- 5 Se adapta cómodamente a cualquier cinturón Makita de hasta 50 mm de ancho.
- 6 Agujero en el lateral para un uso fácil sin quitar la cinta métrica.



La parte trasera rígida del portaflexómetro permite sacar la cinta fácilmente.

Portatijera de poda

- Portaherramientas multiusos (especial tijera de poda) forrado con poliéster duradero para resistir el uso frecuente del accesorio.
- Forma ergonómica diseñada para ser muy versátil tanto para cuchillos, tijeras de podar y otras herramientas.
- 2 alojamientos elásticos adicionales en los lados para sujetar un destornillador o un lápiz.
- Pequeño pero con mucha utilidad. Mantiene las herramientas al alcance de la mano.
- La presilla se adapta a cinturones de hasta 50 mm de ancho.
- Libera las manos para moverse con seguridad en escaleras, techos, andamios, etc.

STRAP/BELT SYSTEM

ANTI SLIP

3 LAYERS

3D SHAPED POUCHES

DURABLE RIVETING

ELASTIC LOOPS



Cinta antideslizante con superficie de goma en la parte superior que evita accidentes por resbalones y caídas en el lugar de trabajo

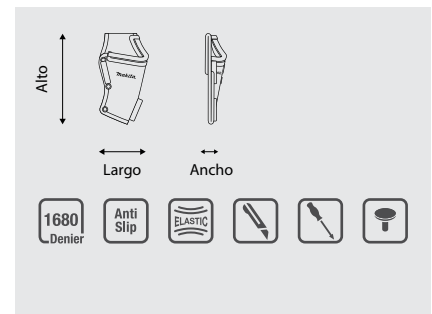

Medidas (L x An x Al)	Peso (Kg)	Capacidad (L)	Unds.	Código	EAN	P.V.P (€)
100 x 50 x 200 mm	0,08	-	1	E-15322	0088381598507	14,30

- 1 Cintas antideslizantes con superficie de goma en la parte superior.
- 2 2 alojamientos elásticos para todos los accesorios importantes.
- 3 Forma especial para tijera de poda.
- 4 Se adapta cómodamente a cualquier cinturón Makita.
- 5 Remaches para mayor durabilidad.



También para jardín

También puedes usar este portaherramientas en exteriores.

Herramientas no incluidas



Make It Right, Make It Makita



TECNOLOGÍAS

STRAP / BELT SYSTEM

HEAVY-LOAD SUPPORT SYSTEM

ELASTIC LOOPS

BELT LOOP HOLDER

DURABLE RIVETING

REAL LEATHER



Cinturón portabolsas

- Perfecto para empezar a montar un juego de portaherramientas personalizado.
- Para tareas muy pesadas. ¡Nunca te defraudará!
- Cómodo de usar incluso cuando se llevan herramientas o accesorios pesados.
- Acabado extremadamente duradero, acolchado extra grueso y hebilla de doble pasador.
- Útil presilla para cinturón incluida para colgar cualquier útil con mosquetón.
- Combinación de cuero resistente con cinta de poliéster ligera.

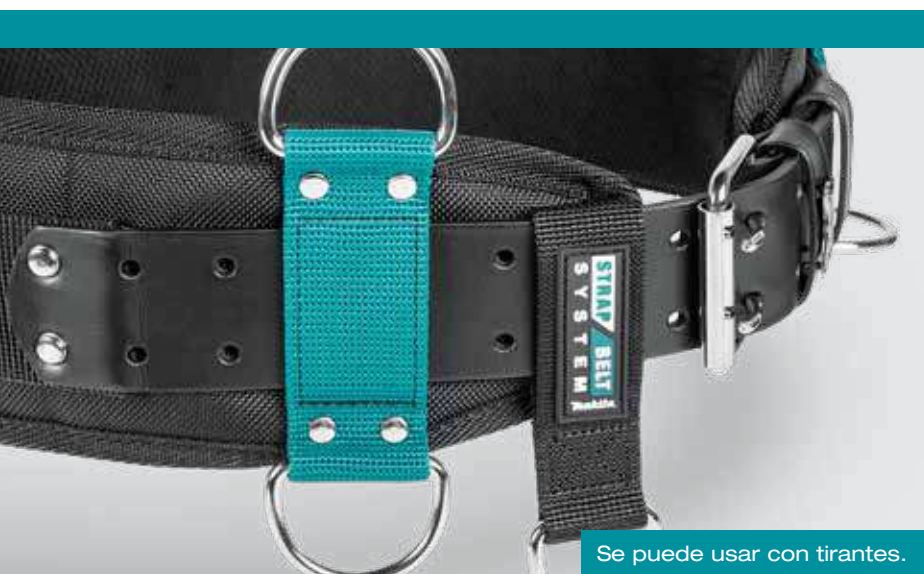

Se puede usar con tirantes.

Medidas (L x An x Al)	Peso (Kg)	Capacidad (L)	Unds.	Código	EAN	P.V.P (€)
880 x 30 x 100 mm	0,66	-	1	E-15366	0088381598545	49,00

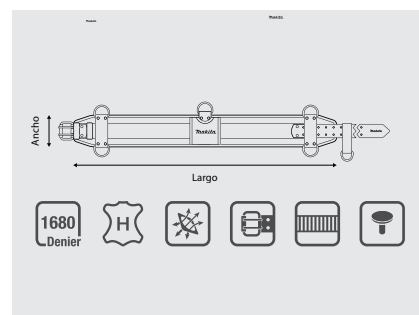

- 1 Hecho en parte de cuero auténtico de alta calidad.
- 2 Presillas de metal.
- 3 Presillas de metal adicionales para accesorios.
- 4 Soporte para cinturón incluido.
- 5 Remaches para una fuerza verdaderamente irrompible.
- 6 El reverso hecho de malla transpirable mantiene el flujo de aire.
- 7 Trabilla de cuero adicional para mantener el cinturón bien ajustado.
- 8 Logotipo de metal de Makita en la presilla del cinturón.
- 9 Hebilla de dos pines para mayor seguridad.
- 10 Dos filas de agujeros de 4,5 mm de diámetro.



Totally padded with 20 mm thick foam for greater comfort



Cinturón básico con cierre rápido

- Cinturón básico perfecto para diversos trabajos.
- Ideal para empezar a montar todo un kit de portaherramientas.
- Asegurado con una hebilla de plástico duradera de alta resistencia.
- Útil presilla incluida para colgar cualquier cosa con mosquetón.
- Construido para transportar múltiples bolsas de trabajo ligeras.
- Costuras dobles alrededor del cinturón para garantizar que las telas no se desprendan ni se deshilachen.



Correa de polietileno en el interior para mantener la forma del cinturón y evitar que se deforme

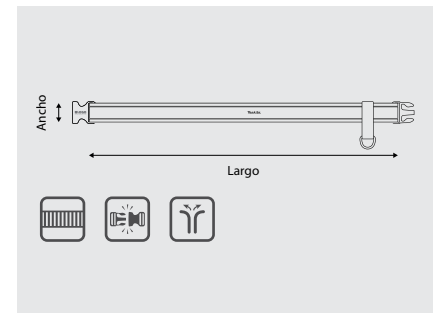

- 1 Hebilla de polipropileno de 50 mm de cierre rápido.
- 2 Presilla incluida.
- 3 Adecuado para usar con cualquier bolsa o portaherramientas Makita.
- 4 Interior de gancho y bucle para ajuste de longitud.
- 5 Logotipo de Makita grabado en la hebilla.

Medidas (L x An x Al)	Peso (Kg)	Capacidad (L)	Unds.	Código	EAN	P.V.P (€)
1550 x - x 50 mm	0,25	-	1	E-05337	0088381566841	17,70



Logotipo de Makita grabado en la hebilla



Cinturón de cuero con hebilla metálica



- Hecho de una sola pieza de cuero auténtico.
- Construcción robusta con remaches.
- A los fans de Makita les encantará. Ideal para el trabajo, y para el uso diario.
- Hebilla metálica y cinturón de cuero negro de 50 mm de ancho.
- Útil presilla incluida para colgar cualquier cosa con mosquetón.
- Makita: la marca más reconocida en productos de ropa de trabajo

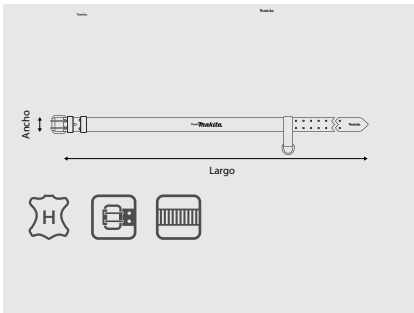

Confeccionado con cuero auténtico de una sola pieza de primera calidad de 50 mm de ancho. Se adapta a todos los tamaños de cintura.

- 1 Dos filas de agujeros de 4,5 mm de diámetro.
- 2 Remaches para mayor resistencia.
- 3 Hebilla resistente y segura.
- 4 Hebilla práctica.
- 5 Presilla incluida.

Medidas (L x An x Al)	Peso (Kg)	Capacidad (L)	Unds.	Código	EAN	P.V.P (€)
1380 x - x 48 mm	0,30	-	1	E-15693	0088381598811	30,00



Logo metálico Makita en la trabilla del cinturón.



Make It Right, Make It Makita



TECNOLOGÍAS

**HEAVY-LOAD
SUPPORT SYSTEM**

ANTI SLIP

Tirantes portaherramientas

- Diseñado para un uso profesional.
- Con enganche para smartphone.
- Estructura anti-deslizante, no se resbalará ni se descolgará de los hombros del usuario.
- Ligera y cómoda, manteniendo una alta resistencia y durabilidad.
- Ajuste de correa del pecho para adaptarse al tipo de cuerpo del usuario.
- Puede combinarse con portabolsas o cinturones completos para una mayor capacidad y mejora de rendimiento.

HEAVY-LOAD
SUPPORT SYSTEM

ANTI SLIP

Medidas (L x An x Al)	Peso (Kg)	Capacidad (L)	Unds.	Código	EAN	P.V.P (€)
520 - 23 - 410 mm	0,47	-	1	E-15372	0088381598552	43,00

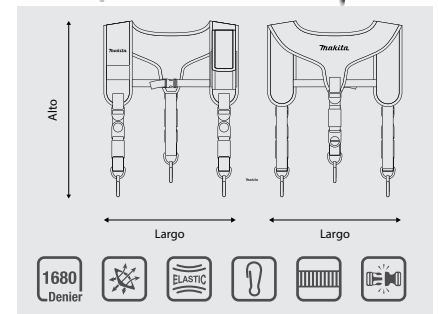

- 1 Parte inferior hecha de malla 3D para mejorar la transpiración.
- 2 Laterales elásticos del enganche para smartphones.
- 3 Hombros adaptativas ergonómicas.
- 4 Ajustadores de longitud.
- 5 Sistema anti-deslizante que mantiene las hombreras en posición
- 6 Enganche para smartphones.
- 7 Hebilla de cierre rápido de 25mm en la correa del pecho.
- 8 Cintas elásticas para inmovilizar las correas de ajuste de longitud.
- 9 Anillas para ajuste rápido de longitud.
- 10 Mosquetones metálicos para conectarse al cinturón.



Con parte de cinta antideslizante para poder colgar otras herramientas.

Herramientas no incluidas



Tirantes

- Para apoyar el peso de la cintura a los hombros.
- Totalmente ajustable, talla única.
- Tirantes de 3 puntos de ajuste que quita peso a la parte baja de la espalda.
- Duradero y hecho de una fuerte banda elástica azul.
- Se adapta tanto a pantalones de trabajo como a pantalones casuales o jeans.



Diseñado para adaptarse tanto a pantalones de trabajo como a pantalones o jeans casuales. Para verdaderos fanáticos de Makita.

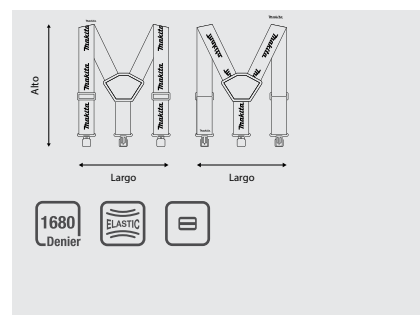

- 1 La almohadilla acolchada garantiza la comodidad del usuario.
- 2 Hecho de una fuerte banda elástica de 50 mm de ancho.
- 3 Metal niquelado de alta calidad.
- 4 Múltiples logotipos visibles de Makita.
- 5 Pinzas de acero de alta resistencia.

Medidas (L x An x Al)	Peso (Kg)	Capacidad (L)	Unds.	Código	EAN	P.V.P (€)
50 x - x - mm	0,24	-	1	E-05402	0088381566919	26,00



También para jardín

Talla única para todos...

- Diseñados para distribuir el peso entre la cintura y los hombros.
- Recién diseñados en color azul Makita con grandes logotipos de Makita en color blanco.
- El color y el logotipo reconocibles con poca visibilidad.



Pinzas de sujeción resistentes

- Cómodos tirantes de longitud ajustable.
- Fuertes costuras industriales para mayor durabilidad.
- Diseñado para uso profesional.
- Totalmente ajustable, talla única.



Unión acholchada por las dos caras



Talla única.



Make It Right, Make It Makita



TECNOLOGÍAS

STRAP BELT SYSTEM

RAIL GUIDE SYSTEM

TOOL LOOPS SYSTEM

WATERPROOF BOTTOM

CS BACKPACK CARRYING SYSTEM

ELASTIC LOOPS

DURABLE RIVETING

3 LAYERS

ANTI SLIP



Maletín portaherramientas reforzado

- 20 alojamientos de plástico de varios tamaños.
- 1 bolsillo frontal para guardar documentación.
- 3 alojamientos elásticos para una gran flexibilidad.
- 4 compartimentos espaciosos y totalmente ajustables para una organización ideal.
- Se pueden guardar clavos, piezas, herramientas, juegos de clavos, lápices, etc.
- Perfecto para un electricista, techador, plomero, carpintero y otros...



El innovador sistema alojamientos para herramientas permite al usuario colocarlas sin tener que realizar ningún ajuste.

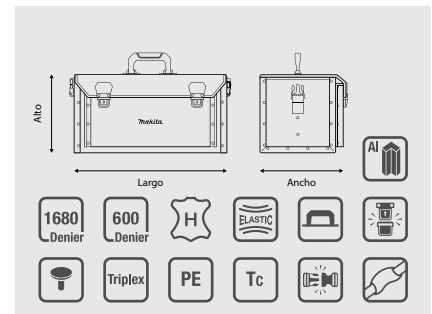

- 1 Guías de carril que dividen el maletín en diferentes compartimentos.
- 2 Innovador sistema alojamientos para herramientas manuales.
- 3 Bolsillo delantero para guardar la documentación u otro tipo de papeles.
- 4 Bloqueos para mantener las herramientas seguras e inmovilizadas.
- 5 Pared transversal.
- 6 Los bordes de aluminio evitan que la carcasa se dañe.
- 7 Correa con hebillas de liberación rápida.
- 8 Remaches para mayor resistencia.
- 9 Logotipo de Makita visible en el frente.
- 10 Refuerzo de solapa fuerte con interior reforzado metálico.

Medidas (L x An x Al)	Peso (Kg)	Capacidad (L)	Unds.	Código	EAN	P.V.P (€)
505 x 295 x 265 mm	3,80	32	1	E-15394	0088381598576	125,00



Bordes de aluminio contra posibles daños.

Herramientas no incluidas



Portaherramientas abierto con asa

- 9 bolsillos exteriores de varios tamaños hechos de poliéster resistente.
- 2 bolsillos laterales con acabado elástico para mayor comodidad.
- 1 bolsillo frontal para la documentación u otros objetos planos.
- 8 alojamientos elásticos el interior de gran flexibilidad.
- 6 alojamientos elásticos en la parte posterior para las herramientas más largas.
- Hasta 30 herramientas en una posición segura.



- Almacena las herramientas verticalmente para facilitar su identificación.
- Su forma cuadrada mantiene el portaherramientas estable.
- Los alojamientos elásticos internos proporcionan una gran capacidad de organización de las herramientas.
- Capaz de portar hasta 30 herramientas manuales de cualquier tipo.
- Diseño abierto para un acceso rápido y sencillo al interior.
- Organice cuidadosamente una gran variedad de herramientas manuales, herramientas eléctricas y accesorios.

STRAP BELT SYSTEM

WATERPROOF BOTTOM

DURABLE RIVETING

ELASTIC LOOPS

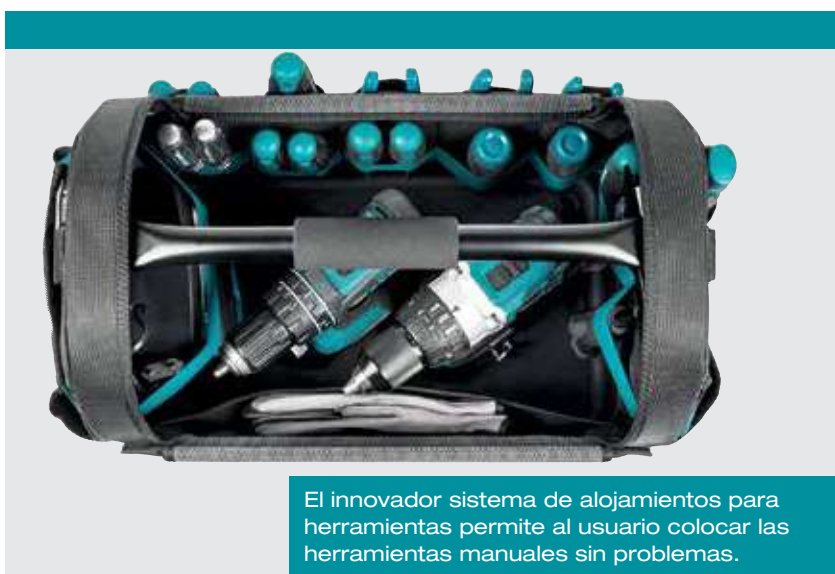

El innovador sistema de alojamientos para herramientas permite al usuario colocar las herramientas manuales sin problemas.

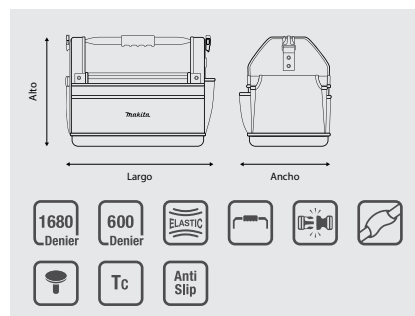

Medidas (L x An x Al)	Peso (Kg)	Capacidad (L)	Unds.	Código	EAN	P.V.P (€)
490 x 310 x 355 mm	2,44	29,70	1	E-15403	0088381598583	86,00



- 1 Asa ergonómica de espuma.
- 2 Asa de acero resistente.
- 3 Correa de liberación rápida
- 4 Base de correa de acero reforzado.
- 5 Costuras industriales para la correa.
- 6 Bolsillo frontal para la documentación.
- 7 Cómoda hombrera de diseño moderno.
- 8 Correa antideslizante con apoyo para hombro de goma.
- 9 Alojamientos elásticos en las paredes internas del portaherramientas.
- 10 Alojamientos elásticos en la pared trasera del bolso.



Herramientas no incluidas

Bolsa portaherramientas

- Más de 20 bolsillos de distintos tamaños para una perfecta organización.
- Bolsa blanda básica perfecta para diversas actividades laborales.
- 9 bolsillos internos.
- 9 bolsillos externos.
- 4 alojamientos elásticos externos para herramientas largas.
- Ideal para llevar herramientas de mano y otros artículos pequeños.



STRAP/BELT SYSTEM

ELASTIC LOOPS



Bolsillos internos y externos para un almacenamiento seguro y ordenado.

Medidas (L x An x Al)	Peso (Kg)	Capacidad (L)	Unds.	Código	EAN	P.V.P (€)
440 x 240 x 250 mm	1,67	25,80	1	E-15431	0088381598613	70,00

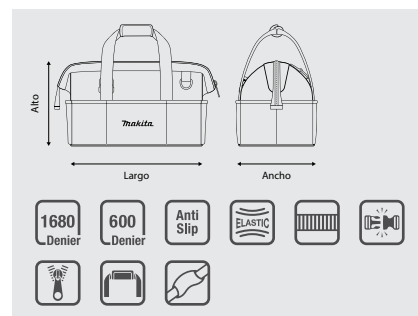

- 1 Gran apertura.
- 2 Acabado de cinta interna azul.
- 3 Cintas antideslizantes con superficie acolchada de goma.
- 4 Presilla para colgar diversas herramientas y accesorios.
- 5 Logotipo de Makita visible en el frontal.
- 6 Correa con hebilla de plástico.
- 7 Hombro acolchado.
- 8 Cremallera de goma.
- 9 Hecho de poliéster 1680D resistente.
- 10 La forma cuadrada mantiene la bolsa estable en todo momento.



Capaz de portar una gran variedad de herramientas y accesorios.

Herramientas no incluidas

Bolsa portaherramientas

- Alta capacidad de almacenamiento de 55L
- Cómoda incluso transportando elementos pesados.
- Con 10 compartimentos, 6 en el interior y 4 en el exterior, ideal para almacenar y organizar objetos de todos los tamaños.
- Estructura reforzada que mejora su durabilidad para soportar y transportar pesos pesados.
- Con varios tipos de asa para llevar en la mano o colgada del hombro.
- Estructura de tres capas que le da resistencia a las condiciones climáticas de exteriores.



STRAP/BELT SYSTEM ANTI SLIP 3 LAYERS



Estructura reforzada para soportar pesos pesados y proporcionar un transporte cómodo.

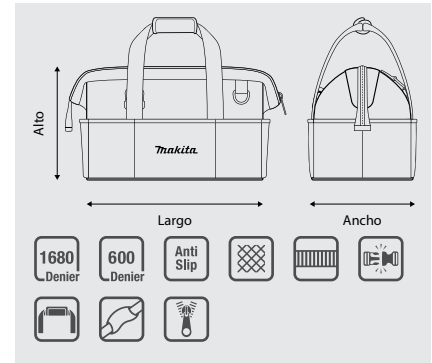

- 1 6 bolsillos exteriores.
- 2 4 bolsillos interiores.
- 3 Estructura reforzada para resistir el transporte de pesos pesados.
- 4 Material de triple capa con gran resistencia a condiciones climáticas adversas.
- 5 Posibilidad de transportar en mano o colgada del hombro.
- 6 Capacidad de 55L.

Medidas (L x An x Al)	Peso (Kg)	Capacidad (L)	Unds.	Código	EAN	P.V.P (€)
330 x 670 x 300mm	-	55	1	E-11782	0088381584159	116,00



Con cinta de velcro para unir ambas correas al transportarlo en mano.



Con instrucciones de uso acopladas de la correa de transporte al hombro.

Bolsa trolley reforzada

- Con trolley de transporte, puede almacenar gran cantidad de objetos y seguir siendo fácil de transportar a pesar del peso.
- Con una boca de apertura muy amplia para poder encajar objetos de grandes dimensiones.
- Con 10 compartimentos, 6 en el interior y 4 en el exterior, ideal para almacenar y organizar objetos de todos los tamaños.
- Estructura reforzada que mejora su durabilidad para soportar y transportar pesos pesados.
- Con varios tipos de asa para llevar en la mano o colgada del hombro.
- Estructura de tres capas que le da resistencia a las condiciones climáticas de exteriores.
- Alta capacidad de almacenamiento de 53,5L.

STRAP/BELT SYSTEM

ANTI SLIP

LAYERS

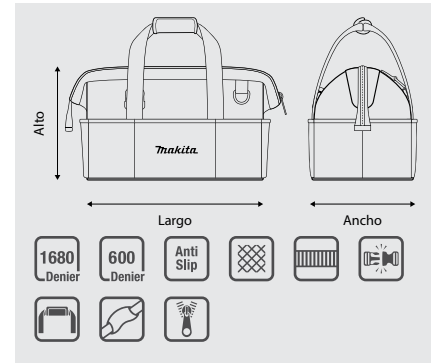

Con trolley incluido; lo que facilita su transporte incluso cuando incluya objetos pesados.

- 1 Amplia apertura principal.
- 2 Con trolley equipado.
- 3 Estructura reforzada para resistir el transporte de pesos pesados.
- 4 Material de triple capa con gran resistencia a condiciones climáticas adversas.
- 5 Posibilidad de transportar en mano o colgada del hombro.
- 6 Con gran cantidad de bolsillos exteriores e interiores.

Medidas (L x An x Al)	Peso (Kg)	Capacidad (L)	Unds.	Código	EAN	P.V.P (€)
330 x 680 x 330mm	-	53,5	1	E-12712	0088381588478	159,00



Con cinta de velcro para unir ambas correas al transportarlo en mano.



Con instrucciones de uso acopladas de la correa de transporte al hombro.



Make It Right, Make It Makita



TECNOLOGÍAS

CS BACKPACK
CARRYING
SYSTEM

**ELASTIC
LOOPS**

**WATERPROOF
BOTTOM**

**TOOL
LOOPS
SYSTEM**

Mochila con organizador de herramientas

- Fácil organización y transporte de cualquier tipo de herramienta
- Ideal para trabajadores de la construcción, electricistas, obreros de reparaciones...
- Una alternativa más fácil de transportar que un maletín de herramientas.
- Permite tener las manos libres a la hora del transporte.
- Puede sujetar de manera segura hasta 50 herramientas manuales en una posición vertical.
- Con un gran número de compartimentos y enganches.

WATERPROOF
BOTTOM

CS
BACKPACK
CARRYING
SYSTEM

TOOL
LOOPS
SYSTEM

ELASTIC
LOOPS



Bolsillo externo con cierre de solapa para un almacenaje seguro

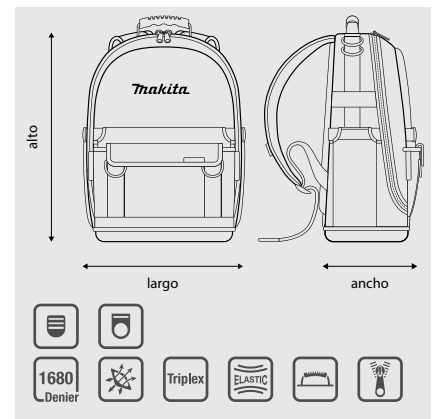

Medidas (L x An x Al)	Peso (Kg)	Capacidad (L)	Unds.	Código	EAN	P.V.P (€)
390 x 230 x 490mm	2,56	22,30	1	E-15481	0088381567022	159,00



- 1 Bolsillo lateral para herramientas largas.
- 2 Cinta elástica para mantener las herramientas en su posición y seguras.
- 3 Dos anillos para colgar herramientas que dispongan de un mosquetón.
- 4 Panel trasero reforzado.
- 5 Cinta lateral para mayor seguridad de las herramientas alargadas.
- 6 Carril de plástico para almacenar todo tipo de objetos.
- 7 Cintas para mantener herramientas fijas.
- 8 Cinta negra elástica para fijar herramientas cortas.
- 9 Cinta azul elástica para fijar herramientas de tamaño medio.
- 10 Cinta negra para inmovilizar herramientas alargadas.



Anillos para enganchar herramientas que dispongan de mosquetón.

Herramientas no incluidas



Funda smartphone

- Protege tu smartphone ante posibles caídas.
- Ideal para almacenar teléfonos grandes o pequeños.
- Con 2 bolsillos externos y 2 cintas elásticas para bolígrafos; además de un bolsillo especial para tarjetas en el interior.
- Más grande que el modelo E-05583 (de 148mm a 172mm de alto).
- Con una pinza y un mosquetón para engancharse a cinturones y gran variedad de anillas.
- Estructura de tres capas que le da resistencia a las condiciones climáticas de exteriores.



La pinza incorporada en la parte posterior hace ideal el encanche en cinturones.

Medidas (L x An x Al)	Peso (Kg)	Capacidad (L)	Unds.	Código	EAN	P.V.P (€)
90 x 40 x 165mm	-	-	1	E-15556	0088381598736	21,00

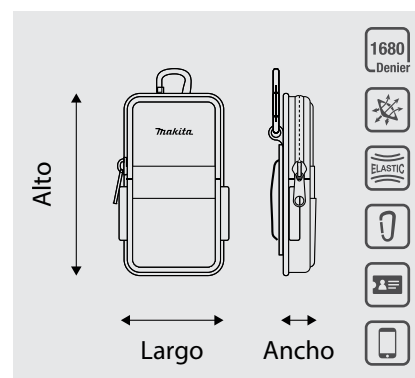

- 1 Muy cómodo y práctico.
- 2 Cintas para almacenar bolígrafos
- 3 Cintas para almacenar tarjetas.
- 4 Mosquetón.
- 5 Pinza trasera.
- 6 Estructura de tres capas que le da resistencia a las condiciones climáticas de exteriores.



Bolsillo interno para proteger los objetos de valor.

Funda smartphone XL

- Protege tu smartphone ante posibles caídas.
- Ideal para almacenar teléfonos grandes o pequeños.
- Con 2 bolsillos externos y 2 cintas elásticas para bolígrafos; además de un bolsillo especial para tarjetas en el interior.
- Más grande que el modelo E-05583 (de 148mm a 172mm de alto).
- Con una pinza y un mosquetón para engancharse a cinturones y gran variedad de anillas.
- Estructura de tres capas que le da resistencia a las condiciones climáticas de exteriores.

STRAP/BELT SYSTEM

ELASTIC LOOPS

LOOP-CLIP SOLUTION

3 LAYERS



La pinza incorporada en la parte posterior hace ideal el encanche en cinturones.

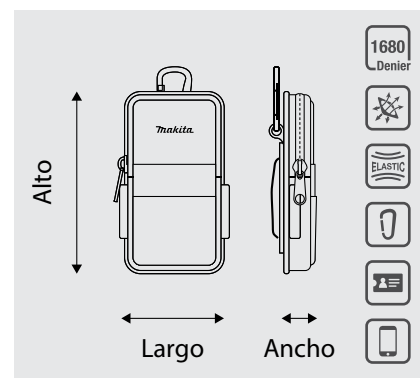

- 1 Mayor tamaño que modelos anteriores
- 2 Cinturas para almacenar bolígrafos
- 3 2 bolsillos frontales.
- 4 Mosquetón.
- 5 Pinza trasera.
- 6 Estructura de tres capas que le da resistencia a las condiciones climáticas de exteriores.

Medidas (L x An x Al)	Peso (Kg)	Capacidad (L)	Unds.	Código	EAN	P.V.P (€)
115 x 40 x 200mm	-	-	1	E-12980	0088381589963	22,00



Bolsillo interno para proteger los objetos de valor.



Chaleco portaherramientas

- Una alternativa al portaherramientas tradicional.
- Libera las manos para moverse con seguridad en escaleras, techos, andamios, etc.
- Dispone de múltiples bolsillos exteriores para una organización perfecta.
- Talla única con ajuste.
- Construcción ligera para la comodidad del usuario.
- Se puede llevar sobre una camiseta, sudadera o chaqueta.

ELASTIC
LOOPS

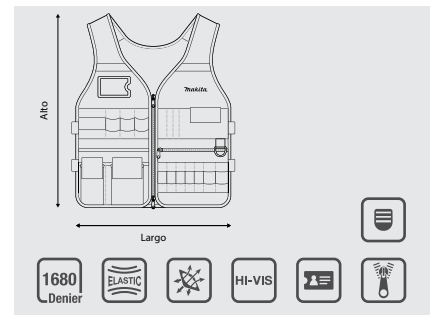

Medidas (L x An x Al)	Peso (Kg)	Capacidad (L)	Unds.	Código	EAN	P.V.P (€)
510 x 640 mm	0,81	-	1	E-15609	0088381598781	77,00



- 1 Cintas ajustables a los lados para según la talla.
- 2 Tira reflectante para mayor seguridad durante el trabajo.
- 3 Plástico transparente para tarjeta de identidad o crédito.
- 4 Los alojamientos elásticos mantienen sus herramientas fijas.
- 5 Bolsillo estrecho con solapa para un almacenamiento seguro.
- 6 Bolsillo ancho con solapa con cierre de seguridad para guardar con seguridad objetos de valor.
- 7 Moderno diseño de goma.
- 8 Bolsillo con cremallera.
- 9 Alojamientos elásticos para bolígrafos, lápices o cualquier tipo de objetos.
- 10 Cierre elástico para el teléfono móvil.



Herramientas no incluidas

Fundas para guías de carril

- Diseñadas para sostener hasta 2 guías de carril, conectores y soportes.
- La funda se adapta a las guías de carril y las protege de rasguños y golpes durante el transporte y almacenamiento.
- Correa de gancho ajustable, bolsillo frontal con cremallera, bolsillos internos para inmovilizar los carriles guía más cortos.
- Duradera y liviana con forro de espuma para protección extra.
- Con asa ergonómica para su transporte y correa para hombro.

STRAP/BELT SYSTEM

3 LAYERS



Bolsillo frontal para almacenar dos sargentos.

Sistema de correa de gancho ajustable para mayor confort.

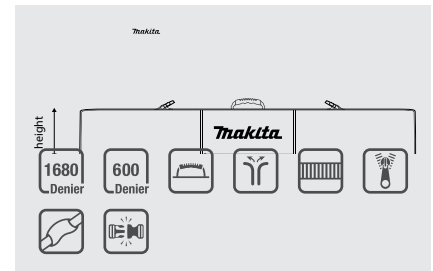

- 1 Bolsillos internos para inmovilizar los carriles guía más cortos.
- 2 Diseñado para almacenar en su interior dos carriles guía.
- 3 Cremallera que recorre la totalidad de la funda para facilitar el almacenaje.
- 4 Cintas y correas ajustables para asegurar los carriles guía.
- 5 Con forro de espuma para protección extra de las guías.

Tamaño de la guía de carril	Peso (Kg)	Capacidad (L)	Unds.	Código	EAN	P.V.P (€)
1 m	1,11	-	1	E-05670	0088381567183	49,00
1,4 / 1,5 m	1,45	-	1	E-05664	0088381567176	57,00
1,9 m	-	-	1	E-10920	0088381581523	89,00
3 m	-	-	1	E-10936	0088381581530	110,00



Cinta de velcro para sujeción



Material acolchado para mayor protección de las guías



Bolsillo externo con cremallera

Herramientas no incluidas

Rodilleras de alta protección

- Rodilleras de alta protección contra cualquier superficie.
- No resbala, ni marca ni daña las superficies.
- Ideal para trabajos en hormigón, suelos de madera, trabajos de construcción o cualquier trabajo relacionado.
- El diseño antideslizante mantiene las rodilleras en su lugar.
- El acolchado de espuma de alta densidad proporciona la máxima comodidad posible.



Las correas elásticas mantienen las rodilleras en una posición cómoda durante todo el día. Ideal para trabajos en hormigón, suelos de madera y trabajos de construcción.

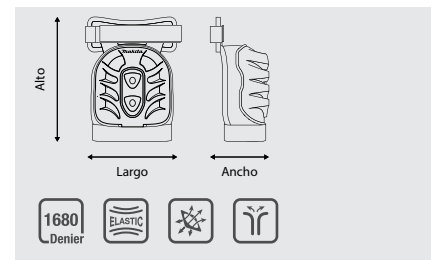

- 1 La cubierta rígida proporciona un uso prolongado en exteriores
- 2 Cubierta especial para una mayor estabilidad del usuario.
- 3 Las correas elásticas se adaptan a la posición de tu cuerpo.
- 4 Talla única.

Medidas (L x An x Al)	Peso (Kg)	Capacidad (L)	Unds.	Código	EAN	P.V.P (€)
170 x 95 x 240 mm	0,52	-	1	E-05658	0088381567169	51,00



Rodilleras de alta protección

Rodilleras flexibles

- El material suave y antideslizante garantiza una gran durabilidad.
- Protege las rodillas.
- No resbala, ni marca, ni daña las superficies.
- Las cintas flexibles mantienen las rodilleras en una posición cómoda durante todo el día.
- Perfecto para pavimentos y alicatados de todo tipo, en garajes, jardines y obras.



Las cintas flexibles y elásticas mantienen las rodillas en su lugar.

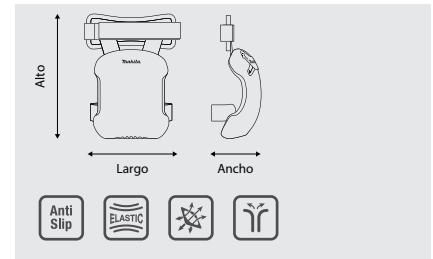

- 1 Hecho de material antideslizante de calidad superior.
- 2 Forro de malla transpirable.
- 3 Las cintas elásticas se adaptan a la posición del cuerpo.
- 4 Talla única.
- 5 Correas de banda elástica con gancho.

Medidas (L x An x Al)	Peso (Kg)	Capacidad (L)	Unds.	Código	EAN	P.V.P (€)
170 x 30 x 240 mm	0,28	-	1	E-15615	0088381598798	34,00



Bolsa para herramientas

- Práctica bolsa funcional de 4 caras.
- 6 bolsillos exteriores de resistente poliéster 1680D
- 6 portaherramientas exteriores elásticos
- 8 portaherramientas internos de banda elástica
- 14 bucles para brocas para una organización completa. Lo lleva todo: clavos, piezas, herramientas, tornillos, lápices, etc.

STRAP BELT SYSTEM

ANTI SLIP

DURABLE RIVETING

ELASTIC LOOPS



Sistema de correas ajustables con hebillas de liberación rápida en los extremos. Herramientas más largas aseguradas por bandas elásticas adicionales.

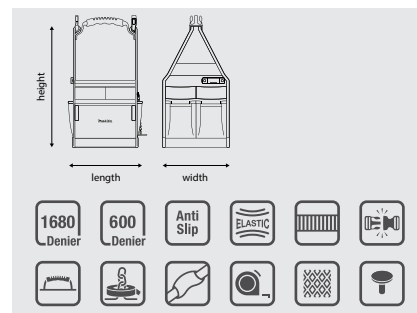

- 1 Cómoda hombrera de diseño moderno
- 2 Hebillas de plástico de liberación rápida
- 3 Cinchas antideslizantes con superficie de goma.
- 4 Alojamientos elásticos para puntas.
- 5 Portaherramientas elásticos en varios lugares alrededor de la bolsa.
- 6 Bucles de banda elástica para mantener rectas las herramientas más largas
- 7 Portacinta de acero inoxidable
- 8 Asa ergonómica que facilita el transporte

Medidas (L x An x Al)	Peso (Kg)	Capacidad (L)	Unds.	Código	EAN	P.V.P (€)
260 x 410 x 220 mm	1,9	-	1	E-15453	0088381598637	66,00



Gancho para inmovilizar la correa de seguridad

Nevera

- Hecho de poliéster 1680D resistente.
- Cómodo asa de transporte.
- Perfecto para la construcción, la oficina o un picnic familiar.
- Protege los alimentos contra el polvo y los escombros de la obra.
- Su construcción resistente evita fugas.
- La bolsa es espaciosa y puede guardar el almuerzo para el trabajo de todo el día.



3 LAYERS

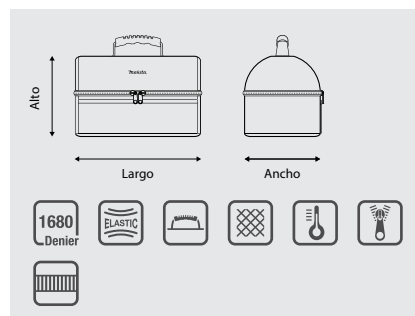

- 1 Práctica red en la parte delantera a modo bolsillo exterior.
- 2 Cremallera para facilitar la apertura.
- 3 Su forma ergonómica mantiene la bolsa estable en todo momento.
- 4 Forro de papel de aluminio de fácil limpieza.
- 5 Asa de goma para un transporte cómodo.

Medidas (L x An x Al)	Peso (Kg)	Capacidad (L)	Unds.	Código	EAN	P.V.P (€)
330 x 180 x 210 mm	0,45	7,5	1	E-15584	0088381598767	35,00



Contenido no incluidas

Bolsa para sierras de cadena

- Insustituible en el bosque. ¡Todo leñador debe tenerlo!
- Mantiene tu motosierra libre de daños durante el transporte o almacenamiento
- Se adapta a las motosierras más populares. Base de plástico incluida, para mayor estabilidad y fácil limpieza
- Hecho de poliéster de alta resistencia 1680D duradero, resistente al desgaste e impermeable



STRAP BELT SYSTEM

WATERPROOF BOTTOM

ELASTIC LOOPS



La base resistente a la abrasión e impermeable se ha fabricado especialmente para inmovilizar la motosierra

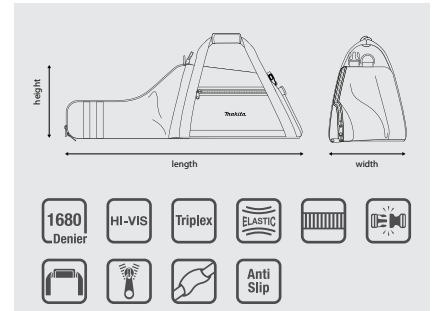

- 1 Bandeja de plástico específica para mantener limpia la bolsa.
- 2 Fabricada especialmente para inmovilizar la motosierra.
- 3 Bolsillo exterior con acabado elástico.
- 4 Banda HI-VIS para hacerte visible en la oscuridad.
- 5 Parte inferior reforzada con una segunda capa de poliéster

Medidas (L x An x Al)	Peso (Kg)	Capacidad (L)	Unds.	Código	EAN	P.V.P (€)
900 x 260 x 270 mm	1,72	-	1	E-15512	0088381598699	78,00



Base estable y segura para su transporte y almacenamiento



Construido especialmente para inmovilizar la motosierra



Bolsillo con cremallera



Bolsillo lateral trasero para herramientas manuales de motosierra

- 6 Dos tiradores de cremallera para facilitar el acceso.
- 7 Cremallera resistente en toda la bolsa.
- 8 Cintas reflectantes para mayor seguridad en el bosque.
- 9 Sistema con correa ajustable.

- 10 Hebillas de plástico de liberación rápida.
- 11 Útil anilla en D para colgar todo lo necesario.
- 12 Almohadilla acolchada para levantarla cómodamente.
- 13 Cinta de polipropileno resistente alrededor de la bolsa.

- 14 Bolsillo frontal con cierre de cremallera
- 15 Práctico tirador para facilitar la apertura.
- 16 Logotipo visible de Makita en la parte delantera.
- 17 Cómoda hombrera acolchada



Anilla en D para colgar el equipo necesario



Baterías, cargadores y compatibilidad de carga



Litio-ion EXTREMA TECNOLOGIA

36V
Cargador rápido



BL3626 194873-2 DC36RA 194863-5

P.V.P 290 € Tiempo de carga **22 min** P.V.P 193,50 €

36V
Cargador normal



BL3622A 195410-5 DC36WA 195471-5

P.V.P 199,50 € Tiempo de carga **60 min** P.V.P 100 €

Ni - MH

24V
Ni-MH

DC24SC
194164-1



175,50€

3,1 Ah



281,50€

BH2433
193739-3

60 min.

MAKSTAR

12V
Ni-MH

DC24SC
194164-1



175,50€

DC18RC
195584-2



120€



DC18SD
194533-6

DC18SE
Automóvil 194622-7

121€

3,1 Ah



166€

BH1233C
193930-3

30 min.

22 min.

70 min.

9,6V
Ni-MH

DC24SC
194164-1



175,50€

DC18RC
195584-2



120€



DC18SD
194533-6

DC18SE
Automóvil 194622-7

121€

3,1 Ah



151,50€

BH9033C
193636-3

30 min.

30 min.

70 min.

1,8 Ah



141€

BH9020
193631-3

20 min.

15 min.

40 min.

Ni - MH

18V

DC1804
193827-6



80€

DC1822
Automóvil
193439-5



111,50€

DC1414
193864-0



65,50€

2,8 Ah



157,50€

1835
193061-8

70 min.

70 min.

14,4V

2,8 Ah



121€

1435
193060-0

70 min.

70 min.

70 min.

18V

2,8 Ah



104€

1235
193059-5

70 min.

70 min.

70 min.

Maletines



Maletines Makpac apilables.

• **Ofrecemos un amplio catálogo para transportar sus equipos de trabajo con las mejores condiciones. Además, podrá expandir sus equipos de trabajo de forma sistemática.**



- Con el almacenamiento MakPac, usted puede en cualquier momento modificar las diferentes formas de almacenamiento, combinarlos por separado y transportar sus dispositivos adicionales.
- En su almacén, las posibilidades son ilimitadas.
- El número de maletines que pueden ser apilados, de hecho, es ilimitada.



• **Tiradores fuertes y retráctiles hacen que el transporte y el almacenamiento se haga de una forma correcta.**

Cuatro tamaños diferentes.

- Dispone de cuatro tamaños diferentes de maletines.
- También puede optar por un plástico específico para almacenar su herramienta correctamente.
- Los maletines MAKPAC son apilables, pueden estar unidos o separados por los cuatro clips de bloqueo manual.
- Una vez que se unen entre sí, se pueden coger con una mano para ser transportados.
- Tiradores fuertes y retráctiles hacen que el transporte y el almacenamiento se haga de una forma correcta.



Tipo 1



Tipo 2



Tipo 3



Tipo 4

Maletines Makpac con cajones

• **Nuevos maletines Makpac con cajones para accesorios**



- Maletines Makpac con cajones, para mayor comodidad y organización. Distribuye fácilmente tornillos, tacos y otros accesorios.
- Posibilidad de unir fácilmente los diferentes productos Makpac.

Descripción	Unds.	Código	EAN	P.V.P. (€)
4 Cajones. 295 x 395 x 210 mm	1	P-84311	0088381580786	195,00
6 Cajones. 295 x 395 x 210 mm	1	P-84333	0088381580809	223,00
12 Cajones. 295 x 395 x 210 mm	1	P-84327	0088381580793	231,00

Set de cajas y caja organizadora para maletines Makpac



Descripción	Unds.	Código	EAN	P.V.P. (€)
Caja organizadora Makpac	1	191X80-2	0088381589987	68,00
Set de cajas	1	191X92-5	-	14,00
Set de cajas	1	P-84171	0088381536035	15,40

Nevera Makpac

¡Estupenda para mantener frías las bebidas en el lugar de trabajo!

- Con un grosor de 20mm de poliestireno, y tiras de sellado en la junta entre la tapa y la caja.

18L



500mL x 20 2L x 4

Dimensiones	Maletín	Unds.	Código	EAN	P.V.P. (€)
295 x 395 x 315mm	Tipo 4	1	198253-4	0088381476607	128,00

Carro de transporte



Descripción	Unds.	Código	EAN	P.V.P. (€)
Carro de transporte Admite hasta 100 kg de carga	1	P-83886	0088381468411	128,00

Trolley con ruedas



Maletín Makpac no incluido

Descripción	Unds.	Código	EAN	P.V.P. (€)
Trolley con ruedas Admite hasta 25 kg de carga.	1	TR00000001	0088381468190	228,00

Plástico interior clasificador



Maletín Makpac no incluido

Descripción	Unds.	Código	EAN	P.V.P. (€)
Clasificador con diferentes compartimentos	1	P-83668	0088381463805	11,60

Plástico interior clasificador de colores

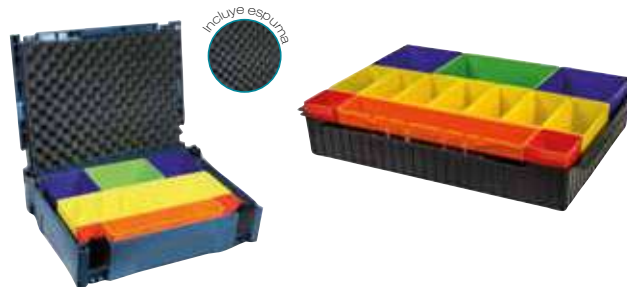

Maletín Makpac no incluido

Descripción	Unds.	Código	EAN	P.V.P. (€)
Clasificador con diferentes compartimentos	1	P-83652	0088381463799	34,00

Separador de espuma

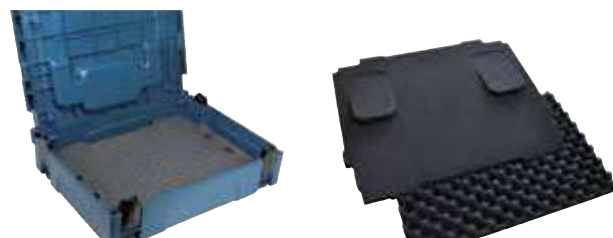

Maletín Makpac no incluido

P-84268

Descripción	Unds.	Código	EAN	P.V.P. (€)
Separador de espuma válido para todos los maletines Makpac	1	P-83705	0088381463843	24,00
Espuma 20mm universal makpac	1	P-84268	-	17,80
Espuma 40mm universal makpac	1	P-84274	-	21,00

Caja herramientas makpac



Descripción	Unds.	Código	EAN	P.V.P. (€)
Práctica caja de herramientas con múltiples compartimentos.	1	P-84137	0088381524865	95,00



TIPOS de maletines Makpac



Tipo 1



Medidas	Unds.	Código	EAN	P.V.P. (€)
39,5 x 29,5 x 10,5 cm	1	821549-5	0088381432986	33,00

Tipo 2



Medidas	Unds.	Código	EAN	P.V.P. (€)
39,5 x 29,5 x 15,5 cm	1	821550-0	0088381430128	36,00

Tipo 3



Medidas	Unds.	Código	EAN	P.V.P. (€)
39,5 x 29,5 x 21,5 cm	1	821551-8	0088381432993	40,00

Tipo 4



Medidas	Unds.	Código	EAN	P.V.P. (€)
39,5 x 29,5 x 31,5 cm	1	821552-6	0088381433006	51,00

Maletín Makpac - PLÁSTICO INTERIOR



Modelo	Modelo de maletín Makpac	Unds.	Código Plástico interior	EAN	P.V.P. (€)
3709	821550-0	1	837674-2	0088381525923	9,40
3710	821550-0	1	837674-2	0088381525923	9,40
4326	821549-5	1	837803-7	0088381436090	8,20
4328	821549-5	1	837803-7	0088381436090	8,20
4329	821549-5	1	837803-7	0088381436090	8,20
6906	821550-0	1	838024-4	0088381436090	11,30
6952	821549-5	1	837869-7	-	8,50
9046	821550-0	1	838025-2	0088381525978	11,30
9403	821551-8	1	837652-2	-	8,80
9404	821551-8	1	837653-0	0088381436359	8,80
9910	821551-8	1	837658-0	0088381436366	8,20
9911	821551-8	1	837658-0	0088381436397	8,20
4350CT	821549-5	1	837803-7	0088381436397	8,20
4350FCT	821549-5	1	837803-7	0088381436090	8,20
4351FCT	821549-5	1	837803-7	0088381436090	8,20
5008MG	821552-6	1	837657-2	0088381436090	10,30
5604R	821552-6	1	837657-2	0088381436489	10,30
5704R	821552-6	1	837657-2	0088381436489	10,30
6904V	821549-5	1	837869-7	0088381436489	8,50
BO4900V	821550-0	1	837675-0	0088381525978	9,00
BO4901	821550-0	1	837675-0	0088381436212	9,00
BO5030	821552-6	1	837247-1	0088381436212	8,80
BO5031	821552-6	1	837247-1	0088381436441	8,80
BO5040	821552-6	1	837247-1	0088381526029	8,80
BO5041	821552-6	1	837247-1	0088381436441	8,80
BO6030	821551-8	1	837654-8	0088381526029	9,30
BO6040	821551-8	1	837655-6	0088381436441	9,00
BO6050J	821551-8	1	838246-6	0088381526029	5,90
BST221	821550-0	1	837640-9	0088381436441	10,00
CA5000	821552-6	1	838390-9	0088381526029	10,60
CC301	821552-6	1	838315-3	0088381436373	7,30
DA330D	821549-5	1	837695-4	0088381436380	10,20
DBN500	821551-8	1	838023-6	0088381526142	7,90
DBN600	821552-6	1	839523-9	0088381436137	4,70
DBO180	821550-0	1	837809-5	0088381526197	8,20
DBO380	821551-8	1	8351P0-7	0088381525978	5,00

Maletín Makpac - PLÁSTICO INTERIOR

Modelo	Modelo de maletín Makpac	Unds.	Código Plástico interior	EAN	P.V.P. (€)
DBO381	821551-8	1	8351P0-7	0088381525985	5,00
DBO382	821551-8	1	8351P0-7	0088381525954	5,00
DBS180	821550-0	1	835P86-9	0088381526180	4,50
DCC501	821551-8	1	835U78-8	0088381436083	3,00
DCS550	821551-8	1	837628-9	0088381453967	9,10
DCS553	821551-8	1	839751-6	0088381526326	5,20
DDA350	821550-0	1	838040-6	0088381437349	7,90
DDF083	821550-0	1	837670-0	-	12,90
DDF343	821550-0	1	837916-4	-	9,70
DDF441	821550-0	1	837916-4	0088381436274	9,70
DDF446	821550-0	1	837916-4	0088381546492	9,70
DDF448	821550-0	1	837916-4	0088381441704	9,70
DDF451	821550-0	1	837916-4	0088381436182	9,70
DDF453	821550-0	1	837916-4	0088381441438	9,70
DDF456	821550-0	1	837916-4	0088381441438	9,70
DDF459	821550-0	1	837916-4	0088381441438	9,70
DDF480	821550-0	1	837916-4	0088381441438	9,70
DDF482	821550-0	1	837916-4	0088381441438	9,70
DDF483	821550-0	1	837670-0	0088381441438	12,90
DDF484	821550-0	1	837916-4	0088381441438	9,70
DDF485	821550-0	1	837916-4	0088381441438	9,70
DDF486	821550-0	1	837916-4	0088381441438	9,70
DDF487	821550-0	1	837916-4	0088381436182	9,70
DF001G	821551-8	1	835F93-2	0088381441438	3,15
DF030D	821549-5	1	837866-3	0088381441438	8,80
DF031D	821549-5	1	838312-9	0088381441438	7,00
DF032D	821549-5	1	838312-9	0088381436182	7,00
DF033D	821549-5	1	838312-9	0088381441438	7,00
DF330D	821549-5	1	837866-3	-	8,80
DF331D	821549-5	1	838312-9	0088381525954	7,00
DF332D	821549-5	1	838312-9	0088381526166	7,00
DF333D	821549-5	1	838312-9	0088381526166	7,00
DFN350	821550-0	1	835B51-4	0088381526166	4,10
DFR550	821551-8	1	837631-0	0088381525954	8,20
DFS250	821550-0	1	837805-3	0088381526166	8,20
DFS251	821550-0	1	837805-3	0088381526166	8,20
DFS451	821550-0	1	837805-3	0088381526166	8,20
DFS452	821550-0	1	837805-3	0088381568777	8,20
DGA452	821551-8	1	837632-8	0088381447201	8,70
DGA454	821551-8	1	838175-3	0088381436250	10,80
DGA458	821551-8	1	838175-3	0088381436250	10,80
DGA461	821551-8	1	838175-3	0088381436250	10,80
DGA463	821551-8	1	838175-3	0088381436250	10,80
DGA467	821551-8	1	838175-3	0088381436250	10,80
DGA469	821551-8	1	838175-3	0088381436250	10,80
DGA504	821551-8	1	838175-3	0088381436281	10,80
DGA508	821551-8	1	838175-3	0088381453981	10,80
DGA511	821551-8	1	838175-3	0088381453981	10,80

Modelo	Modelo de maletín Makpac	Unds.	Código Plástico interior	EAN	P.V.P. (€)
DGA513	821551-8	1	838175-3	0088381453981	10,80
DGA517	821551-8	1	838175-3	0088381453981	10,80
DGA519	821551-8	1	838175-3	0088381453981	10,80
DGD800	821550-0	1	837806-1	0088381453981	8,20
DHK180	821552-6	1	835D35-4	0088381453981	4,70
DHP343	821550-0	1	837916-4	0088381453981	9,70
DHP441	821550-0	1	837916-4	0088381453981	9,70
DHP446	821550-0	1	837916-4	0088381453981	9,70
DHP451	821550-0	1	837916-4	0088381574501	9,70
DHP453	821550-0	1	837916-4	0088381441438	9,70
DHP456	821550-0	1	837916-4	0088381441438	9,70
DHP458	821550-0	1	837916-4	0088381436267	9,70
DHP459	821550-0	1	837916-4	0088381441438	9,70
DHP480	821550-0	1	837916-4	0088381441438	9,70
DHP481	821550-0	1	837916-4	0088381441438	9,70
DHP482	821550-0	1	837916-4	0088381441438	9,70
DHP483	821550-0	1	837670-0	0088381441438	12,90
DHP484	821550-0	1	837916-4	0088381441438	9,70
DHP485	821550-0	1	837916-4	0088381441438	9,70
DHP486	821550-0	1	837916-4	0088381441438	9,70
DHR165	821551-8	1	838109-6	0088381441438	9,10
DHR171	821551-8	1	839387-1	0088381441438	5,60
DHR182	821552-6	1	839891-0	0088381441438	5,60
DHR202	821551-8	1	837634-4	0088381436182	9,60
DHR242	821552-6	1	837649-1	0088381441438	8,80
DHR243	821552-6	1	837649-1	0088381453998	8,80
DHR262	821552-6	1	837650-6	0088381535588	9,10
DHR262T	821552-6	1	837650-6	0088381558785	9,10
DHR263	821552-6	1	837988-9	0088381436304	10,00
DHR264	821552-6	1	837988-9	0088381535595	10,00
DHR280	821552-6	1	839559-8	0088381535595	4,60
DHR281	821552-6	1	839559-8	0088381436472	4,60
DHR282	821552-6	1	839559-8	0088381436472	4,60
DHR283	821552-6	1	839559-8	0088381454001	4,60
DHS660	821551-8	1	839752-4	0088381546485	5,50
DHS661	821551-8	1	839752-4	0088381454001	5,50
DHS680	821551-8	1	838182-6	0088381526333	10,90
DHS710	821552-6	1	837861-3	0088381526333	18,70
DHS782	821552-6	1	835C85-3	-	4,70
DHS783	821552-6	1	835C85-3	0088381526333	4,70
DJN161	821551-8	1	837678-4	0088381526333	12,80
DJS161	821550-0	1	837636-0	0088381441445	7,60
DJV180	821550-0	1	837639-4	-	12,10
DJV181	821551-8	1	837789-5	0088381436229	7,40
DJV182	821550-0	1	837639-4	0088381447195	12,10
DLX2221	821551-8	1	837864-7	0088381436120	5,80
DP3002	821549-5	1	838039-1	0088381441414	8,70
DP3003	821549-5	1	838039-1	0088381436120	8,70



Maletín Makpac - PLÁSTICO INTERIOR

Modelo	Modelo de maletín Makpac	Unds.	Código Plástico interior	EAN	P.V.P. (€)
DP4001	821549-5	1	838039-1	0088381436434	8,70
DP4002	821549-5	1	838039-1	0088381580038	8,70
DP4003	821549-5	1	838039-1	0088381441216	8,70
DP4011	821549-5	1	838039-1	0088381441452	8,70
DPJ180	821551-8	1	837648-3	0088381441452	8,20
DPT351	821550-0	1	837640-9	0088381441452	10,00
DPT353	821551-8	1	839128-5	0088381441452	9,00
DSD180	821550-0	1	838542-2	0088381436342	7,00
DSS501	821551-8	1	837628-9	0088381436137	9,10
DSS610	821551-8	1	837642-5	0088381535601	9,60
DST221	821550-0	1	837640-9	0088381436137	10,00
DTD129	821550-0	1	837670-0	-	12,90
DTD134	821550-0	1	837670-0	-	12,90
DTD146	821550-0	1	837670-0	0088381535755	12,90
DTD147	821550-0	1	837670-0	0088381436274	12,90
DTD148	821550-0	1	837670-0	0088381436328	12,90
DTD152	821550-0	1	837670-0	0088381436182	12,90
DTD153	821550-0	1	837670-0	0088381436182	12,90
DTD154	821550-0	1	837670-0	0088381436182	12,90
DTD155	821550-0	1	837670-0	0088381436182	12,90
DTD156	821550-0	1	837670-0	0088381436182	12,90
DTD157	821550-0	1	837670-0	0088381436182	12,90
DTD170	821550-0	1	837670-0	0088381436182	12,90
DTD171	821550-0	1	837670-0	0088381436182	12,90
DTD172	821550-0	1	837670-0	0088381436182	12,90
DTL061	821550-0	1	837644-1	0088381436182	9,00
DTM50	821551-8	1	837671-8	0088381436182	8,70
DTM51	821551-8	1	837671-8	0088381436182	8,70
DTM52	821551-8	1	835W93-4	0088381436182	4,30
DTP140	821550-0	1	837670-0	0088381453981	12,90
DTP141	821550-0	1	837670-0	0088381453981	12,90
DTS141	821550-0	1	837670-0	0088381436182	12,90
DTW1001	821551-8	1	837645-9	0088381436182	8,80
DTW1002	821551-8	1	837645-9	0088381436144	8,80
DTW180	821550-0	1	837670-0	0088381436182	12,90
DTW181	821550-0	1	837670-0	0088381436182	12,90
DTW190	821550-0	1	837670-0	0088381436182	12,90
DTW250	821550-0	1	837670-0	0088381436427	12,90
DTW251	821550-0	1	837670-0	0088381436427	12,90
DTW281	821550-0	1	837670-0	0088381795319	12,90
DTW285	821550-0	1	837670-0	0088381436182	12,90
DTW300	821550-0	1	835L10-8	0088381436182	4,00
DTW301	821550-0	1	835L10-8	0088381436335	4,00
DTW450	821551-8	1	837645-9	0088381436335	8,80
DTW700	821551-8	1	837645-9	0088381436335	8,80
DTW701	821551-8	1	837645-9	0088381436335	8,80
FS2300	821550-0	1	837805-3	0088381436182	8,20
FS2500	821550-0	1	837805-3	0088381436182	8,20

Modelo	Modelo de maletín Makpac	Unds.	Código Plástico interior	EAN	P.V.P. (€)
FS2700	821550-0	1	837805-3	0088381436182	8,20
FS4200	821550-0	1	837805-3	0088381436182	8,20
FS6300	821550-0	1	837805-3	-	8,20
GA005G	821552-6	1	835E79-0	-	3,20
GA008G	821552-6	1	835E79-0	0088381436335	3,20
GA013G	821552-6	1	835E79-0	0088381436250	3,20
GA016G	821552-6	1	835E79-0	0088381436250	3,20
GA022G	821552-6	1	835E79-0	0088381436250	3,20
GA023G	821552-6	1	835E79-0	0088381436250	3,20
GA026G	821552-6	1	835E79-0	0088381436250	3,20
GA028G	821552-6	1	835E79-0	0088381590556	3,20
GA029G	821552-6	1	835E79-0	0088381590556	3,20
GA032G	821552-6	1	835E79-0	0088381590556	3,20
GA4540	821550-0	1	837672-6	0088381436199	4,70
GA4540C	821550-0	1	837672-6	0088381436199	4,70
GA5040	821550-0	1	837672-6	0088381436199	4,70
GA5040C	821550-0	1	837672-6	0088381436199	4,70
HP001G	821551-8	1	835F93-2	-	3,15
HP2051	821549-5	1	838039-1	0088381441452	8,70
HP2071	821549-5	1	838039-1	0088381441452	8,70
HP330D	821549-5	1	837866-3	0088381436199	8,80
HP331D	821549-5	1	838312-9	0088381436199	7,00
HP332D	821549-5	1	838312-9	0088381436199	7,00
HP333D	821549-5	1	838312-9	0088381436199	7,00
HR001G	821552-6	1	835C84-5	-	3,20
HR002G	821552-6	1	835C84-5	0088381441452	3,20
HR003G	821552-6	1	835C84-5	0088381441452	3,20
HR004G	821552-6	1	835C84-5	0088381525954	3,20
HR140D	821550-0	1	839245-1	0088381526166	5,30
HR166D	821550-0	1	838683-4	0088381526166	6,60
HR1841	821549-5	1	839214-2	0088381526166	5,60
HR2300	821550-0	1	837651-4	-	8,70
HR2600	821550-0	1	837651-4	-	8,70
HR2610	821550-0	1	837651-4	-	8,70
HR2610T	821550-0	1	837651-4	-	8,70
HR2611FT	821550-0	1	837651-4	0088381526258	8,70
HS004G	821552-6	1	835K82-7	-	4,10
HS300D	821550-0	1	837662-9	0088381526241	16,30
HS6101	821552-6	1	837807-9	0088381436151	8,60
HS6601	821551-8	1	838314-5	0088381436151	5,20
HS7101	821552-6	1	837807-9	0088381436151	8,60
HS7601	821552-6	1	838108-8	0088381436151	6,00
JN3201	821550-0	1	837630-2	0088381436151	9,00
JR100D	821549-5	1	837664-5	-	8,80
JS3201	821550-0	1	837630-2	0088381436175	9,00
JV0600	821549-5	1	837803-7	0088381436502	8,20
JV100D	821549-5	1	837665-3	0088381545280	9,80
JV103D	821549-5	1	839186-1	0088381436502	5,50

Maletín Makpac - PLÁSTICO INTERIOR

Modelo	Modelo de maletín Makpac	Unds.	Código Plástico interior	EAN	P.V.P. (€)
Kits baterías 4,0 ah	821552-6	1	839205-3	-	5,60
Kits baterías 5,0 ah	821552-6	1	839205-3	0088381430142	5,60
Kits baterías 6,0 ah	821552-6	1	839205-3	0088381436052	5,60
KP0800	821551-8	1	837659-8	0088381430142	8,20
KP0810	821551-8	1	837659-8	0088381436090	8,20
KP0810C	821551-8	1	837659-8	0088381436069	8,20
N9741	821551-8	1	838026-0	0088381526234	9,40
PJ7000	821551-8	1	837661-1	-	12,30
RP0900	821550-0	1	837646-7	-	8,70
RP0910	821550-0	1	837660-3	-	9,10
RP110C	821550-0	1	837660-3	0088381436403	9,10
RP1800	821552-6	1	837647-5	0088381436403	8,80
RP2300FC	821552-6	1	837647-5	0088381436403	8,80
RT0700C	821552-6	1	837247-1	-	8,80
SA5040C	821550-0	1	837672-6	0088381436410	4,70
SG1251	821552-6	1	838111-9	0088381525916	8,80

Modelo	Modelo de maletín Makpac	Unds.	Código Plástico interior	EAN	P.V.P. (€)
SP6000	821552-6	1	837945-7	0088381436168	8,20
TD001G	821551-8	1	835F94-0	0088381436168	3,30
TD090D	821549-5	1	837866-3	0088381436465	8,80
TD110D	821549-5	1	838312-9	0088381436465	7,00
TD111D	821549-5	1	838312-9	0088381436441	7,00
TM3000C	821550-0	1	837673-4	0088381436199	8,70
TM3010C	821550-0	1	837673-4	0088381526135	8,70
TW001G	821551-8	1	835K85-1	0088381437356	4,10
TW004G	821550-0	1	835R29-3	-	4,10
TW005G	821550-0	1	835R29-3	0088381525954	4,10
TW007G	821551-8	1	835K85-1	0088381526166	4,10
TW008G	821551-8	1	835K85-1	0088381526166	4,10
TW0200	821549-5	1	837869-7	0088381436205	8,50
TW0350	821550-0	1	837870-2	0088381436205	8,10
TW100D	821549-5	1	837866-3	-	8,80



Cierre maletín Makpac



Descripción	Unds.	Código	EAN	P.V.P. (€)
Cierre maletín Makpac	1	453974-8	0088381430135	0,65



MALETINES METÁLICOS / PVC

Modelo	Descripción	Unds.	Código	EAN	P.V.P. (€)
1100	Metálico	1	181790-5	008838118705	106,00
4326	Plástico	1	824572-9	0088381151627	12,70
4327	Plástico	1	824572-9	0088381151627	12,70
4328	Plástico	1	824572-9	0088381151627	12,70
4329	Plástico	1	824572-9	0088381151627	12,70
6807	Plástico	1	824890-5	3240890391902	16,50
6842	Plástico	1	824808-6	0088381347204	36,00
6844	Plástico	1	824808-6	0088381347204	36,00
2107F	Plástico	1	824728-4	0088381197700	48,00
2107FX	Plástico	1	824728-4	0088381197700	48,00
4350CT	Plástico	1	824809-4	0088381345729	25,00
4350T	Plástico	1	824809-4	0088381345729	25,00
4351CT	Plástico	1	824809-4	0088381345729	25,00
5603R	Plástico	1	824555-9	0088381189422	49,00
5604R	Plástico	1	824555-9	0088381189422	49,00
5903R	Plástico	1	193196-5	0088381189385	62,00
6019D	Plástico	1	824723-4	0088381200455	18,20
6096D	Plástico	1	824723-4	0088381200455	18,20
6207DW	Plástico	1	183763-4	0088381139595	25,00
6260D (3baterías)	Plástico	1	824652-1	0088381196949	10,50
6261D (3baterías)	Plástico	1	824852-3	0088381350631	15,10
6270D (3baterías)	Plástico	1	824652-1	0088381196949	10,50
6271D (3baterías)	Plástico	1	824852-3	0088381350631	15,10
6280D (3baterías)	Plástico	1	824652-1	0088381196949	10,50
6281D (3baterías)	Plástico	1	824852-3	0088381350631	15,10
6317D	Plástico	1	183763-4	0088381139595	25,00
6337D	Plástico	1	183763-4	0088381139595	25,00
6347D	Plástico	1	183763-4	0088381139595	25,00
6391D (3baterías)	Plástico	1	824852-3	0088381350631	15,10
6904V	Plástico	1	824698-7	0088381183789	30,00
6905B	Plástico	1	824698-7	0088381183789	30,00
6905H	Plástico	1	824698-7	0088381183789	30,00
6918FD	Plástico	1	824635-1	0088381161145	11,60
6934FD	Plástico	1	824635-1	0088381161145	11,60
6935FD	Plástico	1	824635-1	0088381161145	11,60
6936FD	Plástico	1	824635-1	0088381161145	11,60
6980FD	Plástico	1	824635-1	0088381161145	11,60
8270D	Plástico	1	824635-1	0088381161145	11,60
8280D	Plástico	1	824635-1	0088381161145	11,60
9554NB	Metálico	1	823256-6	-	26,00
9555NB	Metálico	1	823256-6	-	26,00
9557NB	Metálico	1	823256-6	-	26,00
9558NB	Metálico	1	823256-6	-	26,00
AF505	Plástico	1	HY00000090	0088381335218	21,00
BFR440	Plástico	1	824756-9	0088381341981	24,00
BGA452	Plástico	1	824767-4	0088381289702	21,00
BHR162	Plástico	1	824863-8	0088381351010	57,00
BHR200SJEP	Plástico	1	824690-3	-	39,00
BHR202	Plástico	1	141642-2	-	26,00
BJR181	Plástico	1	824760-8	0088381341998	25,00
BO4556	Plástico	1	824806-0	0088381346092	14,50
BO4565	Plástico	1	824806-0	0088381346092	14,50

Modelo	Descripción	Unds.	Código	EAN	P.V.P. (€)
BO5020	Plástico	1	183782-0	0088381189262	25,00
BO5021	Plástico	1	183782-0	0088381189262	25,00
BO5030	Plástico	1	183782-0	0088381189262	25,00
BO5031	Plástico	1	183782-0	0088381189262	25,00
BSS610	Plástico	1	824757-7	0088381252898	32,00
BTW200	Plástico	1	824593-1	0088381158084	37,00
BUC122	Plástico	1	824820-6	3240890258571	50,00
DA4000LR	Plástico	1	824646-6	0088381171052	47,00
DBM080	Metálico	1	P-45135	0088381975247	50,00
DBN500	Metálico	1	821604-3	-	60,00
DF010D	Plástico	1	158775-6	3240890276278	12,40
DF030D	Plástico	1	824842-6	3240890276261	12,30
DF330D	Plástico	1	824842-6	3240890276261	12,30
DF347D	Plástico	1	824981-2	0088381401517	20,00
DF457D	Plástico	1	824981-2	0088381401517	20,00
DGP180	Plástico	1	821840-1	-	44,00
DP4011	Plástico	1	824695-3	0088381184342	16,50
FS2300	Plástico	1	824890-5	3240890391902	16,50
FS2500	Plástico	1	824890-5	3240890391902	16,50
FS2700	Plástico	1	824890-5	3240890391902	16,50
FS4200	Plástico	1	824890-5	3240890391902	16,50
FS6300R	Plástico	1	824890-5	3240890391902	16,50
GA038G	Plástico	1	821841-9	-	56,00
GA7020R	Plástico	1	824958-7	0088381371438	31,00
GA7030R	Plástico	1	824958-7	0088381371438	31,00
GA7040R	Plástico	1	824958-7	0088381371438	31,00
GA9020R	Plástico	1	824958-7	0088381371438	31,00
GA9030R	Plástico	1	824958-7	0088381371438	31,00
GA9040R	Plástico	1	824958-7	0088381371438	31,00
GF600SE	-	-	824990-1	0088381425148	62,00
GN900SE	Plástico	1	824875-1	0088381354509	54,00
HG5002	Plástico	1	HG130442	3240890345578	24,00
HG5012	Plástico	1	HG130442	3240890345578	24,00
HG550V	Plástico	1	HG130442	3240890345578	24,00
HG551V	Plástico	1	HG130442	3240890345578	24,00
HG651C	Plástico	1	HG130442	3240890345578	24,00
HK0500	Plástico	1	824523-2	0088381151849	43,00
HK1810	Metálico	1	150640-5	0088381152426	37,00
HK1820	Plástico	1	824789-4	0088381346108	19,00
HM0860C	Plástico	1	824708-0	0088381187725	42,00
HM0870C	Plástico	1	824905-8	-	76,00
HM0871C	Plástico	1	824904-0	0088381361743	79,00
HM1101C	Plástico	1	140561-9	0088381367639	141,00
HM1111C	Plástico	1	140561-9	0088381367639	141,00
HM1200K	Plástico	1	150583-1	0088381152402	50,00
HM1202C	Plástico	1	824564-8	0088381154536	74,00
HM1203C	Plástico	1	824908-2	0088381359504	109,00
HM1213C	Plástico	1	824908-2	0088381359504	109,00
HM1214C	Plástico	1	824882-4	0088381359788	156,00
HM1303	Metálico	1	182851-4	0088381155618	158,00
HM1304B	Metálico	1	183598-3	0088381183796	112,00
HM1307C	Plástico	1	824898-9	-	152,00

Modelo	Descripción	Unds.	Código	EAN	P.V.P. (€)
HM1317C	Plástico	1	824898-9	-	152,00
HM1317CB	Plástico	1	824898-9	-	152,00
HM1511	Plástico	1	821836-2	-	95,00
HP1620	Plástico	1	824724-2	0088381193887	19,30
HP1621	Plástico	1	824724-2	0088381193887	19,30
HP1631	Plástico	1	824811-7	0088381351140	19,00
HP1640	Plástico	1	824811-7	0088381351140	19,00
HP1641	Plástico	1	824811-7	0088381351140	19,00
HP2050	Plástico	1	824695-3	3240890275165	16,50
HP2051	Plástico	1	824695-3	3240890275165	16,50
HP2070	Plástico	1	824695-3	3240890275165	16,50
HP2071	Plástico	1	824695-3	3240890275165	16,50
HP330D	Plástico	1	824842-6	3240890276261	12,30
HP347D	Plástico	1	824981-2	0088381401517	20,00
HP457D	Plástico	1	824981-2	0088381401517	20,00
HR005G	Plástico	1	821837-0	-	46,00
HR160D	Plástico	1	824550-9	0088381157612	22,00
HR1830	Plástico	1	824695-3	3240890275165	16,50
HR2020	Plástico	1	824695-3	3240890275165	16,50
HR2230	Plástico	1	824799-1	0088381346849	27,00
HR2440	Plástico	1	824695-3	3240890275165	16,50
HR2450	Plástico	1	824695-3	3240890275165	16,50
HR2460	Plástico	1	824799-1	0088381346849	27,00
HR2470	Plástico	1	824799-1	0088381346849	27,00
HR2631FT	Plástico	1	824915-5	-	31,00
HR2800	Plástico	1	824789-4	0088381346108	19,00
HR2810	Plástico	1	824789-4	0088381346108	19,00
HR2811	Plástico	1	824789-4	0088381346108	19,00
HR3200C	Plástico	1	824819-1	3240890266422	59,00
HR3210C	Plástico	1	824825-6	0088381349727	68,00
HR3540C	Plástico	1	824819-1	3240890266422	59,00
HR3541FC	Plástico	1	824825-6	0088381349727	68,00
HR4013C	Plástico	1	196278-2	0088381462976	105,00
HR4500C	Plástico	1	824607-6	0088381160070	67,00
HR4501C	Plástico	1	158274-8	0088381369510	81,00
HR5000	Plástico	1	150589-9	0088381146661	62,00
HR5001C	Plástico	1	824519-3	0088381152952	68,00
HR5201C	Plástico	1	158274-8	3240890306630	81,00
JR001G	Plástico	1	821796-8	0088381579797	40,00
JR3060T	Plástico	1	821621-3	-	25,00
JR3070CT	Plástico	1	821621-3	-	25,00
JV0600K	Plástico	1	824998-5	0088381401487	22,00
KP0800	Plástico	1	824892-1	0088381361408	16,50
PC1100	Metálico	1	181789-0	0088381116213	75,00
PC5001C	Metálico	1	140073-2	0088381358651	77,00
SG150	Metálico	1	B50856	3240890267061	68,00
TD090D	Plástico	1	824842-6	3240890276261	12,30
TW0200	Plástico	1	824703-0	0088381185424	16,20
TW0350	Plástico	1	824702-2	0088381185837	21,00
TW1000	Plástico	1	824737-3	0088381200042	60,00
UC120DWAE	Plástico	1	824491-9	0088381152747	40,00
JV101	Plástico	1	821691-2	-	22,00

Modelo	Descripción	Unds.	Código	EAN	P.V.P. (€)
HR4001	Plástico	1	196183-3	-	100,00
HR4011C	Plástico	1	196185-9	-	106,00
DTM51	Plástico	1	821608-5	-	25,00
BHP458	Plástico	1	143603-8	-	39,00
HS7101	Plástico	1	141736-3	-	61,00
TD110D	Plástico	1	821661-1	-	17,90
DJR187	Plástico	1	821620-5	0088381572385	31,00
DJR181	Plástico	1	141354-7	-	31,00
HS301D	Plástico	1	821663-7	-	22,00
DCG180	Plástico	1	821568-1	0088381437516	67,00
DGA900	Plástico	1	821717-0	0088381536172	62,00
DGA511	Plástico	1	821734-0	-	39,00
CG100	Plástico	1	821710-4	0088381585927	34,00
DJR360	Plástico	1	821670-0	0088381524209	55,00
9069K1	Plástico	1	824707-2	-	16,50
BHR242	Plástico	1	141401-4	0088381432764	32,00



Kits de mantenimiento para martillos



Modelos	Unds.	Código	EAN	P.V.P. (€)
DHR162	1	188580-7	0088381350662	9,00
DHR200	1	195258-5	-	14,50
DHR202	1	195193-7	-	7,80
DHR242 DHR281 DHR282	1	195833-7	-	9,45
DHR243	1	195834-5	-	10,00
BHR261 BHR262 DHR263 DHR264	1	195189-8	-	13,35
HK0500	1	193397-5	-	18,90
HK1810	1	193394-1	-	14,50
HK1820	1	195194-5	-	18,90
HM0810 HM0810T	1	193242-4	-	31,20
HM0830T	1	188048-3	-	21,15
HM0860C	1	195204-8	-	34,65
HM0870C HM0871C	1	195113-1	-	31,20
HM1100 HM1100C	1	193243-2	-	23,45
HM1101C HM1111C	1	195260-8	-	35,70
HM1200 HM1200B	1	193244-0	-	40,95
HM1200K	1	193279-1	-	37,80
HM1202C	1	193391-7	0088381162326	31,20
HM1203C HM1213C HM1214C	1	195114-9	-	37,80
HM1303 HM1303B	1	193393-3	0088381162166	27,85
HM1304 HM1304B	1	195201-4	-	31,20
HM1307C HM1307CB HM1317C	1	195103-4	-	18,90
HM1400	1	193399-1	0088381162210	53,55
HM1801 HM1810	1	195205-6	-	37,80
HM1812	1	197127-6	-	34,65
HR1830	1	188389-7	-	11,15
HR2010	1	193395-9	-	14,50

Modelos	Unds.	Código	EAN	P.V.P. (€)
HR2020 HR2021 HR2432 HR2440 HR2450 HR2450T HR2450FT	1	193606-2	-	18,90
HR2300 HR2600 HR2610	1	195105-0	-	16,70
HR2400	1	193386-0	-	15,55
HR2410 HR2430 HR2431	1	193388-6	-	13,35
HR2230 HR2460 HR2470/T HR2800 HR2810/T HR2811FT	1	195206-4	-	12,30
HR2510	1	193404-4	-	14,50
HR2630	1	196968-7	-	12,30
HR3000C	1	193390-9	0088381162159	23,45
HR3200C HR3210C HR3210FCT	1	195199-5	-	18,90
HR3520 HR3520T	1	193280-6	-	31,20
HR3540C	1	188646-3	-	12,30
HR3850 HR3850B	1	193281-4	-	34,65
HR3850K	1	193282-2	-	40,95
HR4000C	1	193283-0	-	25,70
HR4001C HR4011C	1	195195-3	-	25,65
HR4003C HR4013C	1	196532-4	-	26,70
HR4500C	1	193407-8	0088381162289	25,65
HR4501C HR4511C	1	195210-3	-	27,85
HR5000	1	193284-8	-	23,45
HR5000K	1	193285-6	-	31,20
HR5001C	1	193392-5	0088381163323	31,20
HR5201C HR5211C	1	195191-1	-	27,85
HR5202C HR5212C	1	196865-7	-	37,80



Código	Pag	P.V.P.	Código	Pag	P.V.P.	Código	Pag	P.V.P.	Código	Pag	P.V.P.	Código	Pag	P.V.P.
B-39300	198	31,00	B-47232	60	3,40	B-52598	133	29,00	B-58207	58	7,20	B-64814-20	214	226,00
B-39316	198	29,00	B-47248	60	3,90	B-52607	133	49,00	B-58213	58	8,10	B-64820	214	19,30
B-39322	198	51,00	B-47298	60	2,80	B-52607	133	49,00	B-58229	58	9,50	B-64836	214	15,40
B-39338	198	48,00	B-47307	60	3,60	B-52635	133	29,00	B-58235	58	12,30	B-64842	215	8,60
B-39344	198	46,00	B-47313	60	6,40	B-52635	133	29,00	B-58257	58	21,00	B-64842-5	215	43,00
B-39350	198	45,00	B-47341	60	4,20	B-52641	133	32,00	B-58263	58	28,00	B-64858	214	12,10
B-39366	198	45,00	B-47357	60	5,30	B-52641	133	32,00	B-58279	58	67,00	B-64858-20	214	139,00
B-39372	198	45,00	B-47385	60	3,05	B-52657	133	51,00	B-58388	58	67,00	B-64864	214	14,30
B-39388	198	45,00	B-47391	60	3,60	B-52657	133	51,00	B-58497	58	70,00	B-64870	215	12,40
B-39394	198	45,00	B-47400	60	4,70	B-52750	180	17,00	B-58609	58	80,00	B-64870-20	215	226,00
B-39403	198	45,00	B-47416	60	6,40	B-52788	180	17,00	B-58615	58	29,00	B-64870-5	215	62,00
B-39419	198	45,00	B-47438	60	3,05	B-52819	180	17,00	B-58621	58	33,00	B-64886	216	12,10
B-39425	198	45,00	B-47444	60	3,40	B-52847	180	17,00	B-58637	58	32,00	B-64892	215	18,70
B-39883	140	3,80	B-47450	60	5,00	B-52934	134	5,80	B-58659	58	39,00	B-64901	215	15,40
B-39899	140	3,80	B-47472	60	4,40	B-53986	162	25,00	B-58665	58	36,00	B-64917	215	8,20
B-39908	140	3,80	B-47488	60	5,60	B-53992	162	27,00	B-58687	58	48,00	B-64923	215	9,40
B-39914	140	3,80	B-47503	60	10,50	B-54025	162	35,00	B-58693	58	46,00	B-64939	215	12,10
B-39920	140	3,80	B-47525	60	15,60	B-54031	162	62,00	B-58702	58	52,00	B-64945	216	21,00
B-39936	140	3,80	B-47531	60	4,20	B-54053	162	79,00	B-58718	58	46,00	B-64951	215	25,00
B-39942	140	3,70	B-47547	60	5,60	B-54069	162	102,00	B-58724	58	58,00	B-64967	216	25,00
B-39958	140	4,40	B-47553	60	4,70	B-54081	136	36,00	B-58746	58	52,00	B-64973	214	25,00
B-39964	140	4,40	B-47569	60	5,20	B-54265	253	412,00	B-58752	58	67,00	B-64989	216	9,60
B-39970	140	4,70	B-47575	60	6,10	B-54346	348	198,00	B-58768	58	59,00	B-64995	216	9,90
B-39986	140	4,70	B-47581	60	7,00	B-54352	348	203,00	B-58774	58	74,00	B-65006	216	17,10
B-39992	140	4,70	B-47606	60	11,70	B-54368	348	229,00	B-58780	58	95,00	B-65012	216	18,20
B-40004	140	5,20	B-47612	60	16,10	B-54374	348	271,00	B-59075	62	21,00	B-65028	217	28,00
B-40076	140	3,20	B-47634	60	41,00	B-54380	348	50,00	B-62016	252	16,50	B-65034	217	45,00
B-40098	140	3,20	B-47640	60	5,80	B-54520	108	57,00	B-62496	59	3,40	B-65040	217	25,00
B-40107	140	3,20	B-47656	60	6,40	B-54667	134	2,90	B-62505	59	3,40	B-65056	217	24,00
B-40113	140	3,20	B-47662	60	7,80	B-54673	134	3,80	B-62511	59	4,00	B-65062	218	24,00
B-40135	140	3,70	B-47684	60	5,80	B-54704	63	12,50	B-62527	59	4,30	B-65078	217	39,00
B-40141	140	3,70	B-47690	60	7,20	B-55310	166	56,00	B-62608	59	4,10	B-65084	217	25,00
B-40163	140	4,00	B-47709	60	9,20	B-55326	166	104,00	B-62614	59	4,10	B-65090	217	22,00
B-40185	140	4,00	B-47721	60	12,80	B-55332	166	187,00	B-62620	59	4,70	B-65109	217	22,00
B-40191	140	4,50	B-47737	60	16,70	B-55572	249	18,70	B-62636	59	5,20	B-65115	218	12,10
B-40200	140	5,90	B-47759	60	44,00	B-55588	249	22,00	B-62642	59	5,60	B-66400	220	13,80
B-40216	140	6,20	B-47765	60	5,80	B-55594	249	29,00	B-62664	59	5,50	B-66416	220	14,90
B-40222	140	6,40	B-47771	60	6,70	B-56378	173	3,90	B-62670	59	5,50	B-66422	220	25,00
B-40238	140	7,20	B-47787	60	7,80	B-56390	173	4,40	B-62686	59	6,00	B-66438	220	10,80
B-40244	140	10,40	B-47793	60	10,00	B-56437	99	12,80	B-62692	59	6,60	B-66444	220	25,00
B-40543	258	51,00	B-47802	60	7,20	B-56699	235	47,00	B-62701	59	6,90	B-66450	220	26,00
B-40559	258	51,00	B-47818	60	8,90	B-56714	235	73,00	B-62739	59	7,40	B-66466	221	14,30
B-40565	258	50,00	B-47824	60	10,00	B-56742	235	71,00	B-62745	59	8,00	B-66472	221	7,20
B-40917	179	10,20	B-47830	60	15,60	B-56786	235	61,00	B-62751	59	8,60	B-66494	222	30,00
B-40923	179	10,20	B-47846	60	18,40	B-57336	234	50,00	B-62767	59	8,80	B-66503	222	30,00
B-40939	179	10,20	B-47852	60	45,00	B-57401	100	3,50	B-62773	59	9,90	B-66519	221	41,00
B-40945	179	10,20	B-47868	60	8,10	B-57417	100	3,50	B-62795	59	11,00	B-66547	222	29,00
B-40951	179	11,80	B-47874	60	9,40	B-57423	100	4,10	B-62804	59	11,60	B-66553	222	22,00
B-40967	179	11,80	B-47880	60	10,30	B-57439	100	4,10	B-62810	59	12,10	B-66575	222	22,00
B-40973	179	11,80	B-47896	60	16,20	B-57445	100	5,00	B-62826	59	12,40	B-66793	129	4,90
B-40989	179	11,80	B-47905	60	7,80	B-57451	100	5,00	B-62832	59	12,70	B-66802	129	4,80
B-42438	136	20,00	B-47911	60	9,50	B-57467	100	5,00	B-62854	59	13,20	B-66818	129	6,00
B-42450	136	20,00	B-47933	60	12,30	B-57473	100	5,60	B-62860	59	13,80	B-66824	129	3,30
B-42581	201	14,30	B-47949	60	18,40	B-57489	100	3,70	B-62876	59	14,40	B-66830	129	3,40
B-42597	201	14,30	B-47955	60	22,00	B-57495	100	3,80	B-62882	59	15,70	B-66846	129	3,30
B-42640	236	98,00	B-47961	60	33,00	B-57504	100	3,70	B-62898	59	16,30	B-66852	129	3,40
B-42662	236	98,00	B-47977	60	51,00	B-57510	100	4,40	B-62979	234	31,00	B-66868	130	2,40
B-42830	236	98,00	B-47983	60	14,40	B-57526	100	4,70	B-63149	233	63,00	B-66874	130	2,95
B-42852	236	98,00	B-48751	134	5,10	B-57532	100	14,80	B-63585	255	43,00	B-66880	128	43,00
B-42961	134	19,30	B-48767	134	6,40	B-57548	132	6,60	B-63591	255	51,00	B-67206	254	290,00
B-42977	134	20,00	B-48773	134	17,50	B-57554	134	6,70	B-63600	130	1,75	B-67212	254	495,00
B-42983	134	20,00	B-48789	134	17,50	B-57641	69	233,00	B-63616	130	1,75	B-67240	236	70,00
B-43131	250	17,70	B-48832	239	178,00	B-57679	69	246,00	B-63622	130	1,75	B-67309	236	83,00
B-43147	249	18,50	B-48860	239	196,00	B-57685	69	292,00	B-63638	130	1,75	B-67480	218	48,00
B-43153	250	17,70	B-49046	63	31,00	B-57700	69	361,00	B-63644	130	1,75	B-67496	218	58,00
B-43169	250	18,70	B-49052	62	15,60	B-57738	134	9,30	B-63650	130	1,75	B-68127	59	2,80
B-43175	250	22,00	B-49638	111	118,00	B-57744	134	11,40	B-63666	130	1,75	B-68133	59	2,80
B-43181	249	22,00	B-49703	258	22,00	B-57897	58	5,30	B-63672	130	1,75	B-68177	59	21,00
B-43197	250	22,00	B-49719	258	29,00	B-57906	58	5,60	B-63688	130	1,75	B-68183	59	27,00
B-43206	250	26,00	B-49725	111	149,00	B-57912	58	8,60	B-63694	130	1,75	B-68199	59	33,00
B-43212	249	26,00	B-49884	111	159,00	B-57928	58	8,90	B-63703	130	1,75	B-68208	59	42,00
B-43228	250	26,00	B-50295	106	41,00	B-57940	58	5,30	B-63719	130	2,60	B-68236	59	26,00
B-43234	253	22,00	B-51867	132	36,00	B-57956	58	5,60	B-63725	130	2,60	B-68242	59	31,00
B-43240	254	13,80	B-51910	175	13,10	B-57962	58	5,30	B-63731	130	2,60	B-68258	59	41,00
B-43256	253	28,00	B-51926	175	14,80	B-57978	58	5,60	B-63747	130	2,60	B-68264	59	45,00
B-43262	254	18,70	B-51932	175	16,50	B-57984	58	7,20	B-63753	130	2,60	B-68317	135	25,00
B-43278	253	32,00	B-51954	175	22,00	B-57990	58	8,60	B-63769	130	2,60	B-68389	198	34,00
B-46327	165	39,00	B-51960	175	24,00	B-58001	58	11,90	B-63775	130	2,60	B-68395	198	33,00
B-46333	165	42,00	B-51976	175	30,00	B-58023	58	7,50	B-63781	130	2,60	B-68404	198	29,00
B-46492	60	2,80	B-52043	255	24,00	B-58039	58	9,70	B-63797	130	2,60	B-68410	198	29,00
B-46501	60	3,05	B-52180	140	3,70	B-58045	58	12,20	B-63806	130	2,60	B-68426	198	29,00
B-46517	60	2,80	B-52211	140	4,80	B-58051	58	14,80	B-63812	130	2,60	B-68432	107	47,00
B-46523	60	2,80	B-52233	140	5,60	B-58067	58	6,70	B-64185	234	31,00	B-68448	143	17,30
B-46539														

Código	Pag	P.V.P.	Código	Pag	P.V.P.	Código	Pag	P.V.P.	Código	Pag	P.V.P.	Código	Pag	P.V.P.
D-00066	61	1,30	D-07397	93	8,20	D-15849	99	12,30	D-18465-20	173	32,00	D-31061	92	0,95
D-00072	61	1,60	D-07406	93	8,50	D-15855	99	15,70	D-19180	64	60,00	D-31669	135	54,00
D-00088	61	1,30	D-07412	93	9,00	D-15861	93	1,25	D-19196	77	10,20	D-31778	109	95,00
D-00094	61	1,30	D-07428	93	9,60	D-15877	93	1,25	D-20074	77	9,00	D-33691	108	73,00
D-00103	61	1,30	D-07559	93	7,60	D-15883	93	1,55	D-20694	76	5,60	D-33897	67	14,00
D-00119	61	1,30	D-07565	93	8,20	D-15899	93	1,55	D-20769	105	12,90	D-33906	67	19,00
D-00125	61	1,30	D-07571	93	9,40	D-15908	93	2,20	D-23759	105	10,20	D-33934	67	16,00
D-00131	61	1,30	D-07587	93	10,20	D-15914	93	2,50	D-23793	91	2,10	D-33940	67	20,50
D-00147	61	1,60	D-07593	93	11,90	D-15920	93	3,40	D-23802	91	2,15	D-33956	67	17,00
D-00153	61	2,00	D-07602	93	13,40	D-15936	93	5,40	D-23818	91	2,90	D-33962	67	22,00
D-00169	61	1,60	D-07618	93	15,30	D-15942	91	2,80	D-23824	78	9,60	D-33978	67	19,00
D-00175	61	1,60	D-07624	93	16,90	D-15958	91	2,80	D-23868	79	23,00	D-33984	67	25,50
D-00181	61	1,95	D-07630	93	18,90	D-15964	91	3,05	D-24072	151	4,10	D-33990	67	20,50
D-00197	61	1,95	D-07646	93	22,00	D-15970	91	3,05	D-24094	151	4,70	D-34001	67	28,00
D-00206	61	2,55	D-07652	93	25,00	D-15986	91	3,70	D-24119	151	5,60	D-34017	67	22,00
D-00228	61	1,60	D-07668	93	29,00	D-15992	93	4,30	D-24131	151	6,20	D-34023	67	29,50
D-00234	61	1,95	D-07674	94	1,55	D-16003	93	4,90	D-24153	151	7,00	D-34039	67	22,00
D-00240	61	1,95	D-07680	94	1,55	D-16019	93	5,80	D-24876	112	8,20	D-34045	67	29,00
D-00256	61	1,85	D-07696	94	1,55	D-16025	93	6,20	D-24882	112	9,50	D-34051	67	25,50
D-00262	61	2,00	D-07705	94	1,85	D-16031	93	6,10	D-25616	72	5,60	D-34067	67	39,00
D-00278	61	2,60	D-07711	94	1,85	D-16047	93	6,30	D-25688	112	8,90	D-34073	67	30,00
D-00290	61	3,70	D-07727	94	1,85	D-16053	93	7,00	D-25694	112	10,90	D-34089	67	49,00
D-00309	61	4,50	D-07733	94	1,85	D-16069	93	8,10	D-27034	176	3,40	D-34095	67	42,00
D-00321	61	3,60	D-07749	94	2,20	D-16075	93	10,20	D-27040	176	3,40	D-34104	67	54,00
D-00337	61	4,60	D-07755	94	2,20	D-16106	61	1,30	D-27056	176	3,40	D-34110	67	51,50
D-00359	61	4,50	D-07761	94	2,20	D-16128	61	2,95	D-27062	176	3,40	D-34126	67	57,00
D-00365	61	7,40	D-07777	94	2,85	D-16271	61	4,90	D-27084	176	3,90	D-34132	67	63,00
D-00371	61	5,90	D-07783	94	2,85	D-16287	61	6,20	D-27090	176	3,90	D-34148	67	76,00
D-00387	61	7,70	D-07799	94	2,85	D-16302	61	9,70	D-27109	176	3,90	D-34154	67	70,50
D-00393	61	10,50	D-07808	94	3,10	D-16318	61	17,60	D-27115	176	3,90	D-34160	67	80,00
D-00795	64	5,80	D-07814	94	3,40	D-16346	154	7,30	D-27137	176	7,70	D-34176	74	6,20
D-01155-25	61	23,00	D-07820	94	3,80	D-16368	73	37,00	D-27143	176	7,70	D-34182	74	7,80
D-01161-25	61	25,00	D-07836	94	4,10	D-16863	76	10,00	D-27159	176	7,70	D-34182-10	74	71,00
D-01177-25	61	30,00	D-07842	94	4,10	D-16879	76	6,50	D-27165	176	7,70	D-34198	74	10,00
D-01183-25	61	30,00	D-07858	94	4,40	D-16988	279	11,60	D-27838	178	5,50	D-34207	74	6,20
D-01199-25	61	37,00	D-07945	154	11,90	D-16994	112	3,70	D-27844	178	5,50	D-34213	74	8,10
D-01208-25	61	30,00	D-07951	154	13,30	D-17005	112	4,20	D-27850	178	5,50	D-34213-10	74	76,00
D-03274	61	1,60	D-07967	154	15,70	D-17011	112	4,80	D-27866	178	5,50	D-34229	74	9,60
D-03327	230	12,30	D-08056	61	1,60	D-17027	112	5,50	D-27888	178	6,60	D-34235	74	8,60
D-03333	230	14,70	D-08062	61	7,10	D-17033	112	5,50	D-27894	178	6,60	D-34241	74	14,30
D-03349	230	17,80	D-08517	61	9,10	D-17049	112	5,80	D-27919	178	6,60	D-34366	135	9,80
D-03707-25	61	41,00	D-08682	76	3,60	D-17055	112	6,40	D-27931	178	11,00	D-34805*	79	23,00
D-03713-25	61	36,00	D-08707	76	5,90	D-17061	112	6,40	D-27947	178	11,00	D-34914	135	54,00
D-03729-25	61	41,00	D-08713	72	4,10	D-17077	112	7,30	D-27953	178	11,00	D-35003	169	28,00
D-03903	230	13,50	D-08729	72	3,90	D-17083	112	8,50	D-27969	178	11,00	D-35019	169	27,00
D-03919	230	16,50	D-08735	72	5,20	D-17099	112	8,90	D-28036	177	4,00	D-35025	169	23,00
D-03925	230	21,00	D-09628	230	13,50	D-17108	112	10,20	D-28042	177	4,00	D-35302	154	44,00
D-03931	230	25,00	D-09634	230	14,70	D-17114	112	11,50	D-28058	177	4,00	D-35324-10	74	57,00
D-05181	73	26,00	D-09640	230	31,00	D-17120	112	11,80	D-28064	177	4,00	D-35368	112	3,60
D-05228	91	1,25	D-09656	98	0,90	D-17136	112	12,70	D-28086	177	4,50	D-35374	112	4,30
D-05234	91	1,25	D-09662	98	0,85	D-17142	112	14,60	D-28092	177	4,50	D-35380	112	4,80
D-05240	91	1,25	D-09678	98	0,90	D-17158	112	18,50	D-28101	177	4,50	D-35396	112	5,50
D-05256	91	1,25	D-09684	98	0,90	D-17164	112	22,00	D-28117	177	4,50	D-35405	112	5,70
D-05262	91	1,25	D-09690	98	1,20	D-17170	113	4,30	D-28139	177	7,70	D-35411	112	6,00
D-05278	91	1,25	D-09709	98	1,20	D-17186	113	7,90	D-28145	177	7,70	D-35427	112	6,40
D-05284	91	1,25	D-09715	98	1,30	D-17192	113	3,20	D-28151	177	7,70	D-35433	112	7,00
D-05290	91	1,25	D-09721	98	1,55	D-17251	112	4,50	D-28167	177	7,70	D-35449	112	7,30
D-05309	91	1,25	D-09737	98	1,75	D-17267	112	5,50	D-28173	177	5,50	D-35455	112	7,90
D-05315	91	1,25	D-09743	98	1,85	D-17273	112	6,70	D-28189	177	5,50	D-35461	112	8,20
D-05321	91	1,55	D-09759	98	2,05	D-17289	100	1,45	D-28195	177	5,50	D-35477	112	8,20
D-05337	91	1,55	D-09765	98	2,40	D-17295	100	1,45	D-28204	177	5,50	D-35483	112	8,90
D-05343	91	2,15	D-09771	98	2,65	D-17304	100	1,50	D-28210	177	11,00	D-35499	112	8,90
D-05359	91	2,80	D-09787	98	3,50	D-17310	100	1,55	D-28226	177	11,00	D-35508	112	10,20
D-05365	91	2,80	D-09793	98	3,20	D-17332	100	1,55	D-28232	177	11,00	D-35514	112	11,20
D-05371	91	2,80	D-09802	98	3,80	D-17348	100	1,75	D-28248	177	11,00	D-35520	112	11,50
D-05387	91	3,10	D-09818	98	4,10	D-17354	100	2,05	D-28379	177	14,30	D-35536	112	11,80
D-07026	93	0,95	D-09824	98	4,70	D-17360	100	2,10	D-28385	177	14,30	D-35542	112	12,70
D-07032	93	0,95	D-09830	98	6,10	D-17376	100	2,60	D-28391	177	14,30	D-35558	112	13,00
D-07048	93	0,95	D-09846	98	6,40	D-17382	100	2,75	D-28400	177	14,30	D-35564	112	13,30
D-07054	93	0,90	D-09852	98	7,00	D-17398	100	3,20	D-29050	230	25,00	D-35570	112	14,10
D-07060	93	1,25	D-09868	98	7,60	D-17407	100	3,70	D-29228	80	21,00	D-35586	112	16,10
D-07076	93	1,25	D-09874	98	8,10	D-17413	100	5,00	D-29284	151	6,70	D-35592	112	16,60
D-07082	93	1,55	D-09880	98	8,80	D-17429	100	6,10	D-29290	151	10,20	D-35601	112	17,30
D-07098	93	1,55	D-14093	83	2,80	D-17435	100	6,40	D-29561	151	6,40	D-35617	112	17,90
D-07107	93	2,20	D-14928	99	1,75	D-17441	100	6,40	D-29577	151	8,50	D-35623	112	20,00
D-07113	93	2,80	D-14934	99	2,05	D-17457	100	8,60	D-30140	112	9,50	D-36980	108	29,00
D-07129	93	4,40	D-14940	99	2,05	D-17463	100	9,70	D-30209	277	23,00	D-37194	110	163,00
D-07135	93	6,30	D-14962	99	2,35	D-17479	100	10,80	D-30287	92	0,90	D-37306	103	4,90
D-07141	93	6,90	D-14978	99	3,20	D-17485	100	11,10	D-30293	92	0,90	D-37312	103	6,40
D-07157	93	3,30	D-15235	61	7,70	D-17491	100	13,90	D-30302	92	0,90	D-37328	103	7,60
D-07163	93	3,60	D-15241	61	8,50	D-17500	100	14,00	D-30324	92	0,95	D-37334	103	8,80
D-07179	93	4,40	D-15257	61	11,10	D-17516	100	16,60	D-30346	92	1,25	D-37340	103	9,30
D-07185	93	5,30	D-15263	61	12,40	D-17522	100	17,80	D-30368	92	1,25	D-37356	103	14,00
D-07191	93	6,30	D-15285	79	17,70	D-17538	61	4,50	D-30374	92	1,50	D-37362	103	16,90
D-07200	93	7,50	D-15300	79	18,40	D-17544	6							

Código	Pag	P.V.P.	Código	Pag	P.V.P.	Código	Pag	P.V.P.	Código	Pag	P.V.P.	Código	Pag	P.V.P.
D-37465	103	10,00	D-45593	149	7,00	D-63806	178	2,25	D-68482	276	13,10	D-74217	178	1,85
D-37471	103	13,40	D-45602	149	8,10	D-63812	178	2,25	D-68507	276	16,60	D-74223	178	2,15
D-37487	103	17,50	D-45618	149	4,10	D-63828	178	4,50	D-68557	276	11,50	D-74239	178	2,15
D-37493	103	22,00	D-45624	149	5,00	D-63834	178	4,50	D-68563	276	11,80	D-74245	178	2,15
D-37502	103	11,70	D-45630	149	5,20	D-63840	178	4,50	D-68579	276	14,20	D-74251	178	2,15
D-37518	103	19,10	D-45646	149	7,00	D-63856	178	4,50	D-68591	276	9,40	D-74267	178	4,50
D-37524	103	29,00	D-45652	149	8,10	D-64010	99	1,35	D-68622	276	16,60	D-74273	178	4,50
D-37530	103	51,00	D-45668	147	3,20	D-64026	99	1,35	D-68666	276	11,20	D-74289	178	4,50
D-38299	98	1,25	D-45674	147	4,10	D-64032	99	1,35	D-68694	276	12,80	D-74295	178	4,50
D-38308	98	1,25	D-45680	147	4,70	D-64048	99	1,35	D-68703	276	10,70	D-74304	95	12,70
D-38314	98	1,20	D-45696	147	6,40	D-64054	99	1,35	D-68719	276	15,20	D-74310	95	14,90
D-38336	98	1,25	D-45705	147	3,20	D-64060	99	1,35	D-68753	276	24,00	D-74326	95	16,50
D-38358	98	1,25	D-45711	147	4,10	D-64076	99	1,35	D-68775	276	12,30	D-74332	95	17,70
D-38364	98	1,25	D-45727	147	4,70	D-64082	99	1,35	D-68781	276	13,10	D-74348	95	20,00
D-38386	98	0,90	D-45733	147	6,40	D-64098	99	1,35	D-68806	276	13,60	D-74354	95	24,00
D-38401	98	0,90	D-45749	148	8,80	D-64107	99	1,35	D-68812	276	5,90	D-74360	95	26,00
D-38417	98	0,90	D-45755	148	8,80	D-64113	99	1,50	D-70742	149	11,10	D-74376	95	29,00
D-38423	98	0,90	D-45761	151	11,10	D-64129	99	1,75	D-70758	149	11,10	D-74382	95	34,00
D-38439	98	1,25	D-45777	151	14,00	D-64135	99	1,75	D-70786	205	18,70	D-74398	95	39,00
D-38445	98	1,25	D-46202	105	23,00	D-64141	99	2,00	D-70792	205	18,70	D-74407	95	58,00
D-38451	98	1,25	D-47117	113	48,00	D-64157	99	2,25	D-70801	205	13,10	D-74413	95	67,00
D-38467	98	1,50	D-47123	113	41,00	D-64163	99	2,25	D-70873	204	18,70	D-74429	95	86,00
D-38473	98	1,50	D-47139	113	48,00	D-64179	99	2,50	D-71211	154	15,30	D-74435	95	1,40
D-38489	98	1,80	D-47298	113	109,00	D-64185	99	2,75	D-71962	105	8,50	D-74441	95	1,40
D-38495	98	2,15	D-52554	231	7,70	D-64191	99	3,00	D-72067	238	36,00	D-74457	95	11,00
D-38504	98	2,75	D-52560	231	9,00	D-64200	99	3,25	D-72154	332	25,00	D-74463	95	13,20
D-38510	98	3,30	D-52576	231	11,00	D-64216	99	3,50	D-72160	332	25,00	D-74479	95	16,00
D-38526	98	3,60	D-52582	231	9,70	D-64222	99	4,00	D-72291	231	14,00	D-74485	173	1,05
D-39746	151	4,10	D-52598	231	11,00	D-64238	99	4,00	D-72300	231	15,20	D-74491	173	1,35
D-39768	151	4,70	D-52607	231	12,30	D-64244	99	4,25	D-72316	237	35,00	D-74522	173	3,20
D-39780	151	5,80	D-52613	231	16,70	D-64951	231	11,30	D-72322	237	40,00	D-74572	205	13,10
D-39805	151	7,60	D-52629	231	19,40	D-64967	231	12,90	D-72338	237	45,00	D-74588	205	13,10
D-39827	151	4,90	D-52635	231	22,00	D-64973	231	15,40	D-72780	92	1,80	D-74594	204	13,90
D-39849	151	5,80	D-52766	163	8,70	D-64995	135	10,40	D-72833	104	6,40	D-74619	204	9,90
D-39861	151	5,60	D-53453	93	2,85	D-65953-10	174	7,40	D-72861	105	5,30	D-74625	204	11,50
D-39883	151	5,80	D-53469	93	3,50	D-65969-10	174	8,50	D-72877	104	5,80	D-74631	204	7,20
D-39908	148	2,10	D-53475	93	6,40	D-66008	341	11,00	D-73271	135	4,40	D-74653	205	10,20
D-39914	148	2,35	D-53481	93	7,00	D-67527	104	25,00	D-73324	341	12,00	D-74669	205	13,10
D-39920	148	2,60	D-53497	93	10,20	D-67549	104	49,00	D-73455	106	9,40	D-74728	63	8,80
D-39936	148	2,90	D-53506	93	11,40	D-67561	104	62,00	D-73461	106	32,00	D-74740	134	1,65
D-39942	148	3,50	D-53534	278	67,00	D-67583	104	66,00	D-73477	106	30,00	D-74756	63	9,40
D-39958	149	2,05	D-53540	278	70,00	D-67614	94	1,85	D-73483	104	13,80	D-74778	277	214,00
D-39964	149	2,35	D-53556	278	137,00	D-67692	274	5,60	D-73508	116	17,30	D-74784	277	144,00
D-39970	149	2,60	D-53724	178	3,10	D-67701	274	5,60	D-73514	116	18,60	D-74887	106	17,10
D-39986	149	2,95	D-53730	178	3,10	D-67717	274	5,90	D-73520	116	18,60	D-74893	98	20,00
D-39992	149	3,20	D-53746	178	3,10	D-67739	274	6,70	D-73536	116	11,80	D-74902	98	23,00
D-40004	147	1,75	D-53752	178	3,10	D-67745	274	6,40	D-73542	116	11,10	D-74918	98	26,00
D-40010	147	2,05	D-53827	178	8,00	D-67751	274	6,70	D-73564	152	33,00	D-75297	152	3,50
D-40026	147	2,60	D-53833	178	8,00	D-67767	274	8,60	D-73570	152	33,00	D-75306	152	3,50
D-40032	147	2,90	D-53849	178	8,00	D-67773	274	7,80	D-73586	153	40,00	D-75312	152	3,50
D-40048	100	19,10	D-53855	178	8,00	D-67789	274	10,40	D-73592	153	43,00	D-75328	152	3,50
D-40054	100	29,00	D-54081	104	19,40	D-67804	274	6,20	D-73601	148	1,55	D-75334	152	4,00
D-40060	100	54,00	D-56960	204	2,30	D-67810	274	6,70	D-73617	148	1,80	D-75340	152	4,00
D-40076	100	96,00	D-56982	163	67,00	D-67826	274	7,00	D-73623	148	2,00	D-75356	152	4,00
D-40107	100	73,00	D-56998	163	83,00	D-67832	274	6,70	D-73639	148	2,25	D-75362	152	4,00
D-40135	100	83,00	D-57009	163	97,00	D-67848	274	8,00	D-73645	148	2,80	D-75378	152	4,30
D-40163	100	78,00	D-57065	278	118,00	D-67854	274	8,80	D-73651	149	1,55	D-75384	152	4,30
D-40191	100	95,00	D-61070	169	18,60	D-67860	274	10,20	D-73667	149	1,65	D-75390	152	4,30
D-40200	106	16,00	D-61086	169	19,20	D-67876	274	10,40	D-73673	149	1,85	D-75409	152	4,30
D-40565	75	66,00	D-61092	169	20,00	D-67882	274	11,50	D-73689	149	2,00	D-75415	348	18,70
D-41458	166	58,00	D-61101	169	28,00	D-67898	274	14,40	D-73695	149	2,25	D-75421	348	20,00
D-41464	166	66,00	D-61123	163	8,70	D-67907	274	7,50	D-73704	147	1,45	D-75437	348	22,00
D-41517	141	58,00	D-61145	163	18,70	D-67913	274	7,80	D-73710	147	1,65	D-75443	348	26,00
D-41595-10	163	88,00	D-61151	163	8,70	D-67929	274	8,80	D-73726	147	2,00	D-75459	348	28,00
D-41844	94	6,60	D-61167	163	10,00	D-67935	274	10,20	D-73732	147	2,25	D-75524	174	1,05
D-41925	94	7,80	D-61173	163	22,00	D-67941	274	11,00	D-73798	148	5,00	D-75530	174	1,05
D-42232	94	8,90	D-61189	163	7,50	D-67957	274	13,10	D-73807	148	5,50	D-75568	174	2,10
D-42248	94	9,60	D-61690	131	2,10	D-67963	274	14,40	D-73813	149	4,80	D-75742	104	10,70
D-42254	94	10,20	D-62505	205	4,90	D-67979	274	15,50	D-73829	149	5,00	D-75758	104	15,50
D-42260	94	10,70	D-62511	205	7,00	D-67985	275	7,80	D-73835	147	2,40	D-75764	113	140,00
D-42282	94	11,90	D-62527	205	8,20	D-68024	275	8,00	D-73841	147	3,10	D-75792	152	4,30
D-42298	94	13,70	D-62533	205	4,90	D-68030	275	8,30	D-73857	147	3,60	D-75801	152	4,30
D-42307	94	18,80	D-62549	205	7,00	D-68046	275	11,80	D-73863	147	4,80	D-75817	152	4,30
D-42357	73	32,00	D-62555	205	8,20	D-68052	275	14,20	D-73891	65	7,70	D-75823	152	4,30
D-42450	75	49,00	D-62561	205	4,90	D-68096	275	5,90	D-73900	65	8,20	D-75839	152	5,10
D-44432	169	39,00	D-62577	205	7,00	D-68177	275	8,80	D-73916	65	8,60	D-75845	152	5,10
D-44454	169	30,00	D-62583	205	8,20	D-68183	275	7,00	D-73922	65	10,00	D-75851	152	5,10
D-44476	169	37,00	D-62599	205	4,90	D-68199	275	7,80	D-73938	65	12,90	D-75867	152	5,10
D-44507	169	47,00	D-62608	205	7,00	D-68208	275	7,20	D-73944	65	17,70	DA00000002	342	8,00
D-44529	169	59,00	D-62614	205	8,20	D-68214	275	8,00	D-73950	65	21,00	DA00000169	341	15,45
D-44585	169	82,00	D-62620	205	4,90	D-68220	275	8,80	D-73966	65	24,00	DEAADP06	43	31,00
D-44591	169	89,00	D-62636	205	7,00	D-68236	275	13,40	D-73972	65	1,75	DEAADP08	43	31,00
D-44616	169	94,00	D-62642	205	8,20	D-68242	275	18,70	D-73988	65	4,20	DEADML805	51	186,00
D-44638	169	104,00	D-62658	205</										

Código	Pag	P.V.P.	Código	Pag	P.V.P.	Código	Pag	P.V.P.	Código	Pag	P.V.P.	Código	Pag	P.V.P.
DEBDM806	54	82,00	E-03969	114	21,00	E-07652	347	15,50	E-13253	237	123,00	F-31227	291	16,30
DEBDM808	52	66,00	E-03981	114	27,00	E-08458	137	163,00	E-13312	237	138,00	F-31230	291	17,90
DEBDM815	53	42,00	E-04008	114	27,00	E-08698	105	22,00	E-13552	127	40,00	F-31825	292	14,30
DEBML103	55	30,00	E-04014	114	34,00	E-08713	139	150,00	E-13568	127	12,80	F-31838	292	15,40
DEBML105	53	62,00	E-04020	114	34,00	E-10665	60	6,10	E-13596-12	63	149,00	F-31841	292	17,30
DEBWS06	243	318,00	E-04036	114	39,00	E-10671	60	6,10	E-13611	347	83,00	F-31854	292	19,30
DECADP05	43	32,00	E-04042	114	34,00	E-10718	175	1,65	E-13627	347	91,00	F-32142	292	27,00
DML811	51	315,00	E-04058	114	44,00	E-10724	175	1,95	E-13633	347	98,00	F-32155	292	31,00
DML812	52	159,00	E-04064	114	45,00	E-10730	107	58,00	E-13649	347	9,60	F-32168	292	35,00
DML814	50	452,00	E-04070	114	26,00	E-10861-12	174	21,00	E-13655	347	10,20	F-32171	292	40,00
DML816X	55	82,00	E-04086	114	6,90	E-10877-12	174	24,00	E-13661	347	11,20	F-32647	293	14,90
E-00022	135	235,00	E-04977-5	175	42,00	E-10883	138	215,00	E-14152	114	22,00	F-32650	293	13,20
E-00365	174	1,85	E-05337	384	17,70	E-10899	137	109,00	E-14168	114	25,00	F-32663	293	17,70
E-00371	174	2,40	E-05402	388	26,00	E-10920	242	89,00	E-14174	114	56,00	F-32676	293	20,00
E-00387	174	2,00	E-05658	402	51,00	E-10920	272	89,00	E-14255	92	12,80	F-32689	293	21,00
E-00393	174	2,20	E-05664	242	57,00	E-10920	284	89,00	E-14261	115	260,00	F-32843	291	37,00
E-00402	174	3,00	E-05664	272	57,00	E-10920	401	89,00	E-14299	240	72,00	F-32856	291	42,00
E-00418	174	2,20	E-05664	284	57,00	E-10936	242	110,00	E-14495	58	8,20	F-32869	291	34,00
E-01769	344	3,30	E-05664	401	57,00	E-10936	272	110,00	E-14504	58	9,90	F-32872	291	35,00
E-01775	344	6,20	E-05670	242	49,00	E-10936	284	110,00	E-14510	58	11,60	F-32885	291	37,00
E-01781	344	45,00	E-05670	272	49,00	E-10936	401	110,00	E-14526	58	16,00	F-32898	291	44,00
E-01797	344	4,20	E-05670	284	49,00	E-10958	92	1,60	E-14532	58	7,70	F-33575	292	57,00
E-01806	344	7,90	E-05670	401	49,00	E-10964	92	1,60	E-14548	58	9,40	F-33588	292	59,00
E-01812	344	47,00	E-06270	107	104,00	E-10970	92	1,70	E-14554	58	10,50	F-33591	292	90,00
E-01828	344	4,80	E-06286	127	9,90	E-10986	92	1,85	E-14560	58	14,90	F-81518	293	25,00
E-01834	344	8,70	E-06292	127	9,90	E-11003	92	2,20	E-14576	58	22,00	F-81521	293	19,30
E-01840	344	45,00	E-06317	237	87,00	E-11025	92	2,35	E-14582	58	28,00	GM00001396	51	22,00
E-01909	234	44,00	E-06351	91	1,50	E-11031	92	2,20	E-14635	58	11,00	GM00001499	44	25,00
E-02060	164	40,00	E-06367	91	1,50	E-11053	92	2,95	E-14641	58	14,90	GM00001683	54	21,00
E-02076	164	43,00	E-06373	91	1,50	E-11069	92	3,50	E-14657	58	17,10	GM00002073	51	228,00
E-02967	164	149,00	E-06389	91	1,50	E-11075	92	3,90	E-14663	58	18,20	GM00002283	51	72,00
E-03006-25	174	61,00	E-06410	91	1,50	E-11081	92	4,80	E-14679	58	24,00	GM00002286	51	21,00
E-03121	126	3,30	E-06426	91	1,50	E-11097	239	72,00	E-14685	58	31,00	GM00002287	51	14,30
E-03137	126	3,30	E-06482	91	1,50	E-11324	66	12,50	E-14691	58	17,10	GM00002358	50	12,50
E-03159	126	3,30	E-06498	91	1,50	E-11330	66	17,20	E-14700	58	19,30	GM00002376	51	12,00
E-03165	126	3,30	E-06529	91	1,50	E-11346	66	15,50	E-14716	58	21,00	GM00002377	51	19,00
E-03171	126	3,30	E-06535	91	3,05	E-11352	66	20,00	E-14722	58	28,00	GM00002378	50	190,00
E-03187	126	3,30	E-06541	91	2,40	E-11368	66	18,40	E-14738	58	17,70	H311225	156	70,00
E-03193	126	3,30	E-06557	91	3,30	E-11374	66	23,00	E-14744	58	20,00	HW2500390	353	182,00
E-03202	126	3,30	E-06563	91	3,05	E-11380	66	25,00	E-14750	58	22,00	HW3082750	354	13,50
E-03218	126	3,30	E-06579	91	4,20	E-11396	66	29,00	E-14766	58	25,00	HW3083550	353	80,00
E-03224	126	3,30	E-06585	91	3,40	E-11405	66	29,00	E-14772	58	31,00	HW3086	352	17,30
E-03230	126	3,30	E-06591	91	4,90	E-11411	66	35,00	E-14788	58	39,00	HW3163270	353	171,00
E-03268	126	6,60	E-06600	91	5,50	E-11427	66	34,00	E-14928	62	51,00	HW3320120	352	4,60
E-03274	126	6,60	E-06616	138	138,00	E-11433	66	40,00	E-14934	92	1,85	HW3320130	352	4,60
E-03280	126	6,60	E-06644	115	24,00	E-11449	66	39,00	E-14940	92	1,85	HW3320152	352	9,30
E-03296	126	6,60	E-06650	115	25,00	E-11455	66	45,00	E-14956	92	2,15	HW3640090	354	3,50
E-03305	126	6,60	E-06666	115	25,00	E-11461	66	40,00	E-14984	92	2,40	HW3640630	353	11,60
E-03311	126	6,60	E-06672	115	27,00	E-11477	66	46,00	E-14990	92	2,65	HW3640640	352	3,70
E-03327	126	6,60	E-06688	115	27,00	E-11483	66	50,00	E-15045	92	3,20	HW3640660	353	47,00
E-03333	126	6,60	E-06694	115	28,00	E-11499	66	61,00	E-15051	92	3,50	HW3640670	352	2,45
E-03349	126	6,60	E-06703	115	29,00	E-11508	66	61,00	E-15067	92	4,00	HW3640920	352	29,00
E-03355	126	6,60	E-06719	115	30,00	E-11514	66	75,00	E-15073	92	4,50	HW3640940	352	11,30
E-03361	126	6,60	E-06725	115	33,00	E-11536	104	8,20	E-15089	92	5,40	HW3640950	353	6,40
E-03399	127	8,60	E-06731	115	41,00	E-11689	107	121,00	E-15154	363	30,00	HW3641150	352	11,00
E-03408	127	9,40	E-06747	115	43,00	E-11782	394	116,00	E-15176	364	22,00	HW3641570	353	63,00
E-03414	127	9,90	E-06753	115	43,00	E-11829	108	29,00	E-15182	365	59,00	HW40167	352	54,00
E-03420	127	6,60	E-06769	115	44,00	E-11994	128	8,80	E-15198	366	41,00	HW40551	352	31,00
E-03436	127	6,60	E-06775	115	44,00	E-12011	128	14,90	E-15207	368	52,00	HW40925	352	51,00
E-03442	126	4,40	E-06781	115	45,00	E-12027	126	5,20	E-15213	369	59,00	HW41154	352	26,00
E-03458	126	6,60	E-06797	115	46,00	E-12055	240	303,00	E-15229	370	121,00	HW41163	354	60,00
E-03464	126	6,60	E-06806	115	46,00	E-12217	234	30,00	E-15235	372	149,00	HW41165	353	66,00
E-03470	126	6,60	E-06812	115	48,00	E-12223	234	43,00	E-15241	367	43,00	HW41167	353	105,00
E-03486	126	6,90	E-06828	115	72,00	E-12251	234	61,00	E-15257	374	27,00	HW41175	354	59,00
E-03492	126	9,40	E-06834	115	155,00	E-12267	234	71,00	E-15263	375	27,00	HW41179	353	28,00
E-03517	126	9,90	E-06840	115	10,70	E-12273	234	80,00	E-15279	376	27,00	HW41181	353	75,00
E-03523	126	10,20	E-06856	115	15,00	E-12289	142	14,90	E-15291	378	16,50	HW41185	353	19,30
E-03573	127	25,00	E-06862	115	13,90	E-12304	115	163,00	E-15300	379	15,40	HW41187	353	33,00
E-03632	114	8,60	E-06878	115	32,00	E-12310	115	150,00	E-15322	381	14,30	HW41847	352	55,00
E-03654	114	8,60	E-06884	115	35,00	E-12326	115	163,00	E-15338	380	13,20	HW41849	353	77,00
E-03660	114	8,60	E-06959	115	36,00	E-12354	142	33,00	E-15350	361	12,70	HW46221	352	28,00
E-03676	114	9,10	E-06971	234	48,00	E-12360	130	14,60	E-15366	383	49,00	HY00000212	294	207,00
E-03698	114	11,00	E-07026	106	31,00	E-12360-12	129	177,00	E-15372	387	43,00	JM21000300	259	89,00
E-03707	114	10,50	E-07054	106	26,00	E-12376	130	14,60	E-15394	391	125,00	JM21000320	259	25,00
E-03713	114	10,50	E-07060	138	33,00	E-12376-12	129	177,00	E-15403	392	86,00	JM21000330	259	16,00
E-03735	114	10,90	E-07294	347	107,00	E-12382	130	14,60	E-15431	393	70,00	JM21080230	259	21,00
E-03757	114	11,60	E-07303	347	125,00	E-12398	130	14,60	E-15453	404	66,00	JM21080260	259	11,60
E-03763	114	11,00	E-07319	347	148,00	E-12407	130	10,50	E-15481	397	159,00	JM23000127	244	9,90
E-03779	114	12,10	E-07325	347	33,00	E-12407-12	129	133,00	E-15512	406	78,00	JM23000128	245	0,80
E-03785	114	12,10	E-07331	347	3,40	E-12413	130	10,50	E-15556	398	21,00	JM23000131	245	8,20
E-03791	114	12,70	E-07412	202	47,00	E-12413-12	129	133,00	E-15584	405	35,00	JM23100500	244	11,40
E-03800	114	12,70	E-07428	202	47,00	E-12429	130	10,50	E-15609					

Código	Pag	P.V.P.	Código	Pag	P.V.P.	Código	Pag	P.V.P.	Código	Pag	P.V.P.	Código	Pag	P.V.P.
LE00772796	322	26,00	P-05050	255	55,00	P-16287	74	16,80	P-33059	195	4,40	P-36902	200	12,70
LE00784968	320	71,00	P-05066	255	49,00	P-16293	74	27,00	P-33065	195	4,40	P-36918	200	12,70
LE00785633	321	15,40	P-05088	251	22,00	P-16302	74	17,10	P-33071	195	4,10	P-36924	200	12,70
LE00785637	321	131,00	P-05474	82	27,00	P-16318	74	26,00	P-33087	193	5,00	P-36930	200	12,70
LE00785638	322	17,90	P-05480	82	30,00	P-16324	74	26,00	P-33093	193	5,00	P-36946	200	12,70
LE00791661	321	104,00	P-05496	82	26,00	P-16330	75	52,00	P-33102	193	5,00	P-37091	200	9,90
LE00796587	320	353,00	P-05505	72	9,90	P-16346	74	66,00	P-33118	193	5,00	P-37100	200	9,60
LE00796588	320	65,00	P-05511	72	9,90	P-16352	75	30,00	P-33124	193	4,40	P-37116	200	9,60
LE00822220	322	31,00	P-05527	72	14,90	P-16374	68	257,00	P-33130	193	4,40	P-37122	200	9,60
LE00823195	322	25,00	P-05533	72	16,00	P-16782	136	17,10	P-33142	193	4,40	P-37138	200	9,60
LE00834534	322	20,00	P-05549	79	33,00	P-16994	68	46,00	P-33152	193	4,40	P-37144	200	9,60
LE00837085	320	179,00	P-05555	79	81,00	P-17005	68	64,00	P-33168	193	4,40	P-37150	200	9,60
LE00837096	320	54,00	P-05561	79	48,00	P-17027	70	79,00	P-33174	195	6,90	P-37172	200	10,50
LE00855702	320	236,00	P-05583	79	47,00	P-17033	67	33,00	P-33180	195	6,60	P-37188	200	9,90
LE00864505	322	39,00	P-05608	79	62,00	P-17049	67	42,00	P-33196	195	6,60	P-37194	200	9,40
LE00870131	321	33,00	P-05614	77	22,00	P-17055	67	59,00	P-33205	195	6,60	P-37203	200	9,10
LE00870134	321	46,00	P-05620	77	16,50	P-17077	67	37,00	P-33211	195	6,60	P-37219	200	9,10
LE00870137	321	77,00	P-05636	77	15,60	P-17083	67	45,00	P-33233	195	6,30	P-37225	200	9,10
LE00874658	320	110,00	P-05642	77	21,00	P-17108	67	37,00	P-33249	195	6,30	P-37231	200	11,60
LE00929103	322	46,00	P-05658	77	25,00	P-17114	67	46,00	P-33255	193	4,10	P-37328	200	11,00
LE00929104	321	83,00	P-05664	77	31,00	P-18029	153	62,00	P-33255	219	4,10	P-37334	200	10,50
ML001G	53	54,00	P-05670	77	67,00	P-18035	153	62,00	P-33261	193	4,10	P-37340	200	9,60
ML002G	54	126,00	P-05686	77	40,00	P-18041	153	62,00	P-33261	219	4,10	P-37356	200	9,60
ML003GZ	51	231,00	P-05692	80	30,00	P-18057	153	68,00	P-33277	193	4,10	P-37362	200	9,60
ML005GX	50	330,00	P-05701	80	52,00	P-18150	83	47,00	P-33277	219	4,10	P-37378	200	9,60
ML006GX	55	90,00	P-05717	80	75,00	P-19233	153	68,00	P-33283	193	3,90	P-37378	200	9,60
ML007G	52	182,00	P-05723	80	29,00	P-19249	153	68,00	P-33283	219	3,90	P-37839	197	7,40
ML009GX	50	555,00	P-05929	268	14,30	P-21375	131	22,00	P-33299	193	3,90	P-37845	197	6,90
ML010G	50	950,00	P-05941	143	46,00	P-21381	131	22,00	P-33299	219	3,90	P-37851	197	6,60
P-00860	198	4,50	P-05963	143	40,00	P-21397	131	22,00	P-33308	193	3,90	P-37867	197	6,30
P-00882	198	5,90	P-06030	131	8,80	P-21406	131	22,00	P-33314	193	3,90	P-37873	197	6,30
P-00907	198	5,90	P-06046	131	26,00	P-21593	131	5,00	P-33314	219	3,90	P-37889	197	6,30
P-00913	198	5,90	P-06052	131	8,80	P-21618	131	22,00	P-33320	193	3,90	P-37895	197	6,30
P-00935	198	6,20	P-06068	131	25,00	P-21727	205	15,40	P-33320	219	3,90	P-37904	197	6,30
P-00957	198	5,40	P-06074	131	8,80	P-21733	205	10,80	P-33336	193	3,90	P-37910	197	6,30
P-00979	198	6,70	P-06080	131	25,00	P-21777	199	13,20	P-33342	197	5,00	P-37926	197	6,30
P-00985	198	6,70	P-06096	131	8,80	P-22012	116	26,00	P-33358	197	4,70	P-37932	197	6,30
P-00991	198	7,00	P-06105	131	25,00	P-22028	116	27,00	P-33364	197	4,40	P-38037	198	9,10
P-01002	198	7,30	P-06111	131	8,80	P-22040	116	33,00	P-33370	197	4,40	P-38043	198	8,20
P-01018	198	7,30	P-06127	131	25,00	P-22056	116	39,00	P-33386	197	4,40	P-38059	198	8,20
P-01030	198	8,50	P-06133	131	8,80	P-22062	116	11,00	P-33392	197	4,40	P-38065	198	8,20
P-01052	198	8,70	P-06149	131	25,00	P-23721	75	52,00	P-33401	197	4,40	P-38102	196	8,60
P-01074	198	8,70	P-06177	131	14,30	P-24935	72	18,20	P-33417	197	4,40	P-38118	196	6,60
P-01080	198	8,70	P-06199	131	14,30	P-24941	72	13,80	P-33423	197	4,40	P-38124	196	5,80
P-01096	198	8,10	P-06323	131	14,30	P-24957	72	19,30	P-33439	198	11,00	P-38130	196	5,50
P-01105	198	8,10	P-06339	131	14,30	P-24963	72	28,00	P-33445	198	8,60	P-38146	196	5,50
P-01127	153	65,00	P-06345	131	14,30	P-25080	72	14,90	P-33451	198	8,20	P-38152	196	5,50
P-01155	153	65,00	P-06351	131	14,30	P-25096	72	70,00	P-34718	168	26,00	P-38168	196	5,50
P-01199	201	11,00	P-06367	131	14,30	P-25105	73	20,00	P-34724	169	18,70	P-38174	196	5,50
P-01208	201	11,00	P-06373	131	14,30	P-25111	73	27,00	P-35807	193	5,80	P-38180	196	4,40
P-01214	201	11,00	P-06389	131	14,30	P-26191	64	44,00	P-35813	193	5,50	P-38196	196	59,00
P-01220	201	11,00	P-08361	83	3,30	P-26200	64	58,00	P-35829	193	5,20	P-38205	196	48,00
P-01236	201	11,00	P-10067	169	16,80	P-26216	64	59,00	P-35835	193	5,20	P-38211	196	42,00
P-01395	201	12,10	P-10073	169	17,70	P-26222	64	65,00	P-35841	193	5,20	P-38227	196	39,00
P-01404	201	12,10	P-11835*	121	13,20	P-30031	169	22,00	P-35857	193	5,20	P-38233	196	39,00
P-02319	70	157,00	P-13041	76	22,00	P-31566	265	11,20	P-35863	193	5,20	P-38249	196	39,00
P-02325	116	11,00	P-13057	76	16,00	P-31572	265	8,30	P-35879	193	5,20	P-38255	196	39,00
P-02331	116	15,40	P-13063	76	18,60	P-31588	265	10,90	P-35885	193	5,20	P-38261	196	39,00
P-02347	116	14,90	P-13079	76	22,00	P-31594	266	11,40	P-35891	194	5,00	P-38277	196	39,00
P-02353	116	34,00	P-13100	76	40,00	P-31837	194	3,90	P-35900	194	5,00	P-38283	291	31,00
P-03763	68	9,40	P-13122	77	16,40	P-31843	194	3,60	P-35916	194	5,00	P-38788	268	15,50
P-03779	68	91,00	P-13138	77	21,00	P-31859	194	3,60	P-35922	194	5,00	P-38794	268	15,50
P-03785	68	95,00	P-13144	77	16,70	P-31865	194	3,60	P-36011	194	3,60	P-39394	201	32,00
P-03791	68	116,00	P-13150	77	20,00	P-31871	194	5,50	P-36027	194	3,60	P-39419	201	32,00
P-03800	68	131,00	P-13166	77	29,00	P-31887	194	5,00	P-36033	194	3,60	P-39425	201	32,00
P-03816	68	154,00	P-13188	77	25,00	P-31893	194	5,00	P-36049	194	3,60	P-40082	170	771,00
P-03822	68	178,00	P-13219	77	58,00	P-31902	194	5,00	P-36136	194	3,30	P-40098	170	37,00
P-03838	68	10,00	P-13231	81	19,30	P-31918	197	7,70	P-36142	194	3,05	P-40107	170	1,95
P-03844	69	146,00	P-13253	81	25,00	P-31924	197	7,40	P-36158	194	3,05	P-40113	170	10,20
P-03850	69	178,00	P-13275	81	19,30	P-31930	197	7,20	P-36267	195	4,40	P-40129	170	4,70
P-03866	69	220,00	P-13297	81	22,00	P-31946	197	6,90	P-36273	195	4,10	P-40288	170	13,20
P-03872	69	280,00	P-13306	81	29,00	P-31952	197	6,90	P-36289	195	4,10	P-41551	168	26,00
P-03888	69	60,00	P-13312	81	33,00	P-31968	197	6,90	P-36398	192	4,10	P-41604	168	36,00
P-03894	69	50,00	P-13334	81	58,00	P-31974	197	6,90	P-36407	192	3,60	P-41610	168	42,00
P-03925	69	97,00	P-13378	78	19,00	P-31980	197	6,90	P-36413	192	3,30	P-41626	168	52,00
P-03931	69	22,00	P-13384	78	25,00	P-31996	197	6,90	P-36429	192	3,30	P-41632	168	67,00
P-03947	75	82,00	P-13390	78	26,00	P-32007	197	6,90	P-36516	192	5,00	P-41648	168	85,00
P-04008	69	138,00	P-13409	78	20,00	P-32013	197	6,90	P-36522	192	4,40	P-41676	169	52,00
P-04014	69	196,00	P-13415	78	26,00	P-32094	192	3,60	P-36538	192	4,40	P-41682	169	51,00
P-04020	69	200,00	P-13487	79	32,00	P-32910	192	3,30	P-36544	192	4,40	P-41698	169	42,00
P-04036	69	396,00	P-13493	79	65,00	P-32926	192	3,30	P-36550	192	4,40	P-41707	169	48,00
P-04400	152	116,00	P-13502	79	33,00	P-32932	192	3,05	P-36566	192	4,40	P-41735	170	13,20
P-04416	153	93,00	P-13518	79	78,00	P-32948	194	3,05	P-					

Código	Pag	P.V.P.	Código	Pag	P.V.P.	Código	Pag	P.V.P.	Código	Pag	P.V.P.	Código	Pag	P.V.P.
P-42715	193	4,10	P-52180	173	1,40	P-67393	76	33,00	SC00000213	326	116,00	YL00000003	43	41,00
P-42721	193	4,10	P-52196	173	2,55	P-67745	64	22,00	SC00000215	326	116,00			
P-42737	193	4,10	P-52205	173	1,40	P-67745	169	22,00	SC00000217	326	116,00			
P-42743	193	4,10	P-52211	173	3,05	P-67751	64	34,00	SC00000219	326	116,00			
P-42759	193	4,10	P-52227	173	3,30	P-67767	254	26,00	SC00000221	326	116,00			
P-42765	193	4,10	P-52233	174	3,30	P-67773	131	17,70	SC00000223	326	116,00			
P-42868	192	6,60	P-52249	174	1,40	P-67789	131	21,00	SC00000244	326	116,00			
P-42874	192	6,60	P-52255	174	1,40	P-67795	131	17,70	SC00000246	326	116,00			
P-42880	192	6,30	P-52819	173	4,70	P-67804	131	21,00	SC00000248	326	116,00			
P-42896	192	6,30	P-52928	173	1,95	P-70297	316	30,00	SC00000250	326	116,00			
P-42905	192	6,30	P-52934	173	1,95	P-70346	313	32,00	SC00000252	326	116,00			
P-42911	192	6,00	P-52940	173	1,65	P-70346	315	32,00	SC00000254	326	116,00			
P-42927	192	6,00	P-52962	173	2,20	P-70378	313	25,00	SC00000256	326	116,00			
P-42933	192	6,00	P-52978	173	1,65	P-70378	316	25,00	SC00000258	326	116,00			
P-43022	195	7,70	P-52984	173	1,95	P-70415	316	10,50	SC00000260	326	116,00			
P-43038	195	7,20	P-52990	173	2,80	P-70421	313	20,00	SC00000262	326	116,00			
P-43044	195	6,90	P-53001	174	1,40	P-70421	316	20,00	SC00000264	326	116,00			
P-43050	195	6,60	P-53017	174	1,40	P-70421	316	20,00	SC00000266	326	116,00			
P-43066	195	6,60	P-53023	174	1,45	P-70437	313	37,00	SC03300790	325	86,00			
P-43072	195	6,00	P-53039	174	1,45	P-72899	316	28,00	SC03801080	325	94,00			
P-43088	195	6,60	P-53045	174	1,40	P-72908	313	26,00	SC05332710	326	116,00			
P-43094	195	6,60	P-53051	174	1,45	P-72942	313	30,00	SC05340040	326	116,00			
P-43181	201	5,80	P-53067	174	3,30	P-72942	315	30,00	SC05340050	326	116,00			
P-43197	201	5,80	P-53073	174	1,40	P-77730	66	39,00	SC05340060	326	116,00			
P-43206	201	5,50	P-53089	174	1,95	P-77746	66	46,00	SC05340070	326	116,00			
P-43212	201	5,50	P-53095	174	1,45	P-77768	66	162,00	SC05340080	326	116,00			
P-43228	201	5,50	P-53126	174	1,40	P-77774	66	44,00	SC05340090	326	116,00			
P-43234	201	5,50	P-53148	173	4,10	P-77780	66	48,00	SC05340100	326	116,00			
P-43240	201	5,50	P-53154	173	5,50	P-77805	66	165,00	SC05340110	326	116,00			
P-43256	201	6,60	P-53263	132	18,70	P-77811	66	44,00	SC05340120	326	116,00			
P-43262	201	6,60	P-53914	70	204,00	P-77827	66	50,00	SC05340130	326	116,00			
P-43278	201	6,30	P-53920	70	29,00	P-77833	66	73,00	SC05340140	326	116,00			
P-43284	201	6,30	P-53936	70	36,00	P-77855	66	49,00	SC05340150	326	116,00			
P-43290	201	6,30	P-53942	70	50,00	P-77861	66	54,00	SC05340160	326	116,00			
P-43309	201	6,30	P-54075	132	19,30	P-77877	66	77,00	SC05340200	326	159,00			
P-43315	201	6,30	P-54178	169	210,00	P-77883	66	179,00	SC05340210	326	159,00			
P-43321	201	8,60	P-54184	169	30,00	P-77899	66	52,00	SC05340220	326	159,00			
P-43337	201	8,20	P-54190	170	1.417,00	P-77908	66	60,00	SC05340230	326	159,00			
P-43343	201	8,00	P-54221	169	104,00	P-77914	66	51,00	SC05340240	326	159,00			
P-43359	201	7,70	P-57102	168	72,00	P-77920	66	60,00	SC05340250	326	159,00			
P-43365	201	7,70	P-57118	168	74,00	P-77936	66	90,00	SC05340260	326	159,00			
P-43371	201	8,00	P-57124	168	74,00	P-77958	66	65,00	SC05340270	326	159,00			
P-43387	201	8,00	P-57146	168	74,00	P-77964	66	57,00	SC05340280	326	159,00			
P-43533	197	5,50	P-57152	168	75,00	P-77970	66	68,00	SC05340290	326	159,00			
P-43549	197	5,20	P-57174	168	77,00	P-77986	66	88,00	SC05340300	326	159,00			
P-43555	197	5,00	P-63797	75	44,00	P-77992	66	105,00	SC05340310	326	159,00			
P-43561	197	5,00	P-63806	168	104,00	P-78003	66	196,00	SC05352510	326	116,00			
P-43577	197	5,00	P-63921	168	177,00	P-78019	66	63,00	SE00000078	41	17,70			
P-43583	197	5,00	P-64060	168	42,00	P-78025	66	74,00	SE00000101	41	26,00			
P-43599	197	5,00	P-64076	168	44,00	P-78031	66	65,00	SE00000501	41	15,40			
P-43608	197	4,70	P-64082	168	46,00	P-78047	66	79,00	SE00000679	41	33,00			
P-43614	197	4,70	P-64098	168	46,00	P-78053	66	120,00	SH00000034	315	84,00			
P-44074	133	12,70	P-64107	168	50,00	P-78075	66	78,00	SH00000042	315	12,70			
P-45082	169	37,00	P-64113	168	51,00	P-78081	66	90,00	SH00000058	315	26,00			
P-45680	253	18,30	P-64129	168	52,00	P-78097	66	109,00	SH00000060	315	79,80			
P-45696	253	22,00	P-64272	80	50,00	P-78134	66	94,00	SH00000065	313	50,40			
P-45705	249	18,30	P-64288	80	50,00	P-78140	66	111,00	SH00000213	313	89,25			
P-45711	249	22,00	P-64319	90	30,00	P-78156	66	111,00	SH00000231	313	64,05			
P-45727	249	27,00	P-64331	90	36,00	P-78162	66	134,00	SH00000313	313	90,30			
P-45749	267	8,60	P-64347	64	6,70	P-78178	66	179,00	SH00000314	313	44,10			
P-45864	293	15,90	P-64347	90	6,70	P-78184	66	244,00	STEX122299	208	112,00			
P-45870	293	17,10	P-64462	90	31,00	P-78190	66	189,00	STEX122312	156	68,00			
P-45886	293	21,00	P-64478	90	31,00	P-78215	66	215,00	STEX122312	317	68,00			
P-45892	293	25,00	P-64484	90	35,00	P-81088	320	90,00	STEX122385	286	39,00			
P-45901	293	27,00	P-64490	90	36,00	P-81309	322	77,00	TD00000111	43	66,00			
P-45917	293	30,00	P-64509	90	37,00	P-81315	320	269,00	TE00000333	46	0,85			
P-45923	292	12,40	P-64515	90	39,00	P-81739	313	39,00	TE00000334	46	0,55			
P-45939	292	14,10	P-64521	90	41,00	P-81739	314	39,00	TE00000335	46	0,60			
P-45945	292	16,50	P-64537	90	45,00	P-81745	313	22,00	TE00000597	46	1,35			
P-45951	292	17,70	P-64543	90	45,00	P-81745	316	22,00	TEB0000006	41	34,00			
P-45967	292	21,00	P-64559	90	45,00	P-81789	313	28,00	TK02100200	322	20,00			
P-46997	249	16,10	P-64565	90	46,00	P-81789	315	28,00	TKOLDG301G	320	343,00			
P-47008	249	21,00	P-64571	90	49,00	P-84084	313	70,00	TKOLDG501G	320	243,00			
P-47014	254	15,40	P-64587	90	56,00	P-84084	314	70,00	TKOLM4001F	320	151,00			
P-47064	253	20,00	P-64593	90	57,00	PDC1200A01	41	1.984,00	TKOLM5030F	320	218,00			
P-47086	251	13,70	P-64602	90	58,00	PDC1200A02	41	1.863,00	UA-1048	341	4,50			
P-47092	251	14,90	P-64618	90	59,00	PILOTL	101	9,60	W107402706	313	15,40			
P-47101	252	21,00	P-64630	90	61,00	PILOTS	101	7,70	W107402706	315	15,40			
P-47117	251	16,60	P-64646	90	66,00	PR00000028	288	8,20	W107418350	313	35,00			
P-47123	252	17,80	P-64652	90	68,00	PR00000029	288	8,20	W107418350	315	35,00			
P-47173	255	17,20	P-64668	90	89,00	PR00000030	288	10,50	W107418351	316	66,00			
P-47189	254	16,10	P-64685	353	22,00	PR00000031	288	8,80	W107418352	316	39,00			
P-47195	254	21,00	P-64864	354	18,70	PR00000032	288	17,40	W107418353	316	39,00			
P-47204	267	10,60	P-64870	354	10,50	PR00000033	288	19,20	W107418355	316	35,00			
P-47210	267	10,00	P-64892	353	46,00	PR00000034	288	8,20	W107418661	316	20,00			
P-47226	267	8,30	P-64901	352	41,00	PR00000035	288	11,10	W107418688	313	30,00			
P-47232	268	8,30	P-64917	352	89,00	PR00000039	288	9,60	W107418688	316	30,00			
P-47357	346	9,10	P-65648	152	112,00	PR00000041	288	22,00	W14295	315	4,40			
P-47363	346	11,00	P-65931	80	39,00	SC00000203	326	116,00	W29541	316	4,70			
P-49622	267	11,20	P-65947	80	39,00	SC00000205	326	116,00	W6084	313	5,50			



A series of 20 horizontal blue lines for writing notes, arranged in a column on the right side of the page.

Makita

Horizontal lines for writing notes.

Makita



Álava
01012 Vitoria
Talleres Ramón - Aitor Gómez Ortiz De Zárate
Portal de Arriaga, 59
Telf.- 945 27 58 80

Albacete
02005 Albacete
González Tébar, Espj
C/ Teruel, 21
Telf.- 967 22 87 62

Alicante
03015 Alicante
Alicantina de Electromecánica
C/ Rafael García Vidal, 16
Telf.- 965 24 18 37

Alicante
03204 Elche
Electricidad Mateu e Hijos
C/ La Torre, 47
Telf.- 966 63 66 55

Alicante
03204 Elche
Elmec Torres, S.L.
Avda. Llauradors, 5
Telf.- 966 65 53 10

Almería
04003 Almería
Rep. Elect. José Sánchez Alfaro
C/ Méndez, 11
Telf.-950 23 00 10

Ávila
05003 Ávila
Montajes Eléctricos Diego Diez
C/ De Los Hornos Caleros, 66
Telf.- 920 22 01 50

Badajoz
06300 Zafra
Reparaciones Eléctricos Vázquez, S.L.
Pol. Ind. Los Caños, S/N C/Zujar, P-282-E
Telf.- 924 55 41 66

Baleares
07004 Palma De Mallorca
Talleres Guillamón - Idea Bros, S.L.
C/ Merce Rodoreda, 11b
Telf.- 971 75 27 50

Baleares
07760 Ciudadela, Menorca
Electromecánica Maybo, S.L.
C/ Fusters, Parcela 11, Modulo 5
Telf.- 971 38 48 39

Baleares
07813 Puig D'en Valls
Talleres Rigo Ibiza Cb
C/ Ses Baldragues, 6
Telf.- 971 31 04 63

Barcelona
08004 Barcelona
Mecaeléctric - Daniel Rivas Figueras
C/ Ricart,23
Telf.- 93 008 46 52

Barcelona
08100 Mollet Del Valles
Som Asistencia Tools
Avinguda Libertad 32
Telf.- 93 109 51 25

Barcelona
8205 Sabadell
Electromecanica Ferrando
C/ Raimon Casellas, 44
Telf.- 93 712 35 37

Barcelona
08224 Tarrasa
Talleres Prats, Scp
C/ Josep Trueta, 100
Telf.- 93 789 06 58

Barcelona
08520 Les Franqueses del Vallés
Bobinajes Robles S.L.
C/ Verge de Monserrat, 5
Telf.- 93 846 39 53

Barcelona
08800 Vilanova I La Geltru
Victor Huguet Llaverias
C/ Carrer de L'aigua, 4
Telf.- 93 893 00 11

Barcelona
08904 L'hospitalet de Llobregat
Talleres Perser - Esteve Barba Velarde
Pasaje Oliveras, 16
Telf.- 93 334 25 98

Burgos
09007 Burgos
Electro Caor
C/ Alcalde Martín Cobos, Sn Pol. Ind. Villayuda
Telf.- 947 48 42 22

Burgos
09200 Miranda del Ebro
Talleres Eléctricos Ebro, S.L.
Pol. Ind. Bayas R-124
Telf.- 947 33 01 51

Cádiz
11405 Jerez de la Frontera
Comosa - Moisés Sánchez Rodríguez
C/ Torreblanca, 7 Local C
Telf.- 956 34 85 01

Castellón
12500 Vinaros
Cyo Electromecánica Scp
Calle José Sebastián Farga, 18. Bajo 1
Telf.- 964 45 01 51

Ciudad Real
13005 Ciudad Real
Alquileres Ciudad Real, S.L.
Pol. Ind. Ctra. Carrión, Avd. Isaac Peral N-118
Telf.- 902 45 46 50

Ciudad Real
13300 Valdepeñas
Leandro Marques Romero
C/ Veracruz 109
Telf.- 926 31 30 11

Córdoba
14013 Córdoba
Bobinados Pastor, S.L.
C/ Ingeniero Rivera S/N, Pol. Amargecena
Telf.- 957 34 31 32

Córdoba
14800 Priego de Córdoba
Rafael Sánchez Ruiz
C/ Ramón y Cajal, 81 Bajo
Telf.- 957 70 01 82

La Coruña
15570 Ferrol
Electricidad Alycar, S.L.
Pol. Ind. La Gandara, Avda. Nicasio Pérez, Parc 8
Telf.- 981 32 04 81

La Coruña
15650 Cambre
Electromecánica Mayan
Rua Zeppelin, 21-23 Parc. 19 Nave 1
Telf.- 981 64 98 65

La Coruña
15660 Cambre
Istega S.L.
Ctra. De Cambre al Temple, 106-A Barcala
Telf.- 981 25 41 25

La Coruña
15890 Santiago de Compostela
Talleres Eléctricos Lorenzo S.L.
Pol. Ind. Del Tambre, Via Copérnico 13
Telf.- 981 588 039

Gerona
17003 Gerona
Jordi Planas Grabulosa (Planas Mateu Electric)
C/ Botet I Siso, 9
Telf.- 972 21 21 53

Gerona
17005 Gerona
X.Palahi SI
Polg. Mas Xirgu, C/ Falgas, 5
Telf.- 972 402 410

Gerona
17520 Puigcerda
Josep M Sirvent Puig
Carre Puigmal, 5
Telf.- 972 14 10 95

Gerona
17820 Banyoles
Fercon Eines SI
C/ Dels Escatlars, 2
Telf.- 972 570 864

Granada
18006 Granada
Tall. Electromecánico Lupiáñez, S.L.
C/ Juncos S/N, Pol. Ind. La Purísima
Telf.- 958 12 60 20

Granada
18151 Ojigares
Talleres Eléctricos Imbersa S.L.
Pol. Tecnológico De Ojigares-Armilla Nave 88
Telf.- 958 50 70 33

Guipúzcoa
20014 San Sebastián
Electrozor - Miguel Ángel Zorzano Imana
Pº. Urbarburu, 9 - Pol. 27
Telf.- 943 45 14 93

Guipúzcoa
20120 Hernani
Talleres Electromecánicos Loyola, S.L.
Pol. Ind. Zubiondo Industrialdea , Parcela C-5
Telf.- 943 45 24 80

Huesca
22006 Huesca
Talleres Eléctricos La Alameda, S.L.
C/ La Magantina, 21
Telf.- 974 24 11 18

Jaen
23001 Jaen
S.C.A Electromecánica Higuera
Ctra. De la Guardia, Carril 4 Izda.
Telf.- 953 23 94 22

León
24199 Sta. Olaja de la Ribera
Comercial Talleres Electron, S.L.
Ctra. De Villarroaño, 135
Telf.- 987 20 18 17

Lerida
25001 Lerida
Electroequip. Luis Fernando Fuentes
C/ Ludovicus Plus, 7 Baixos
Telf.- 973 21 40 07

La Rioja
26005 Logroño
Félix Lázaro López
C/ Valdeosera, 6-8 (Entrada Por Carmen Medrano)
Telf.- 941 20 20 42

La Rioja
26006 Logroño
González Electricidad S.L.
C/ Piqueras 52
941 23 09 07

Lugo
27004 Lugo
Electromecánica Pombo, S.L.
C/ Acacia, 18 Bajo
Telf.- 982 21 13 48

Lugo
27004 Lugo
Albatros Lugo, Cb
C/ Trapero Pardo, 10 Bajo
Telf.- 982 21 69 01

Madrid
28019 Madrid
Talleres Euromadrid
C/ Arroyo Opañel,6
Telf.- 91 565 06 24

Madrid
28400 Collado Villalba
J. Cogorro, S.L.
C/ Nicolasa Fernández, 5
Telf.- 91 850 49 72

Madrid
28903 Getafe
Viremaq, S.L.
Avda. De los Ángeles, 57
Telf.- 91 695 50 61

Madrid
28906 Getafe
Velasco Maquinaria S.L.
C/ Trabajo 3, Nave 2, Pol. Ind. Los Olivos
Telf.- 91 696 27 55

Málaga
29006 Málaga
Fercam Maquinaria Herramientas, S.L.
C/ Doctor Saenz de Tejada, 18
Telf.- 952 35 29 41

Murcia
30007 Zarandona
José Ángel García Jiménez
Ctra. De Alicante, 271
Telf.- 868 19 07 98

Murcia
30817 Lorca
Diego García Grau
Cno. Viejo del Puerto, S/N - Pol. Ind. Los Peñones
Telf.- 968 46 19 82

Navarra
31192 Mutilva Baja
J. A. De La Fuente
C/ K, Nº 6, Pol. Ind. Mutilva N/4
Telf.- 948 24 93 23

Orense
32003 Orense
Talleres Ramón - Avelino Salgado Fdez.
C/ Avilés de Taramancos 34-36, local B
Telf.- 988 37 03 91

Asturias
33012 Oviedo
Comercial Y Talleres Ferpra, S.L.
C/ Gregorio Marañón, 19
Telf.- 985 23 46 96

Pontevedra
36004 Pontevedra
Ransen
C/ Sta. Teresa Jesús Jornet
Telf.- 986 84 48 13

Pontevedra
36204 Vigo
Talleres Amoedo, S.L.
Ctra. Provincial, 31 B
Telf.- 986 41 16 96

Pontevedra
36211 Vigo
Masna - Manuel Santos Navarrete
C/ Pintor Colneiro, 7 Semisotano
Telf.- 986 41 68 99

Salamanca
37004 Salamanca
Reparalia - Begoña Iglesias Ullan
C/ Acacias, 9
Telf.- 923 22 31 59

Cantabria
39006
Santander Badysat - Javier Badía Anievas
C/ Fernando de los Ríos, 62 B
Telf.- 942 36 70 71

Cantabria
39600 Revilla De Camargo
Oxido 21, S.L.
Centro Empresas Camargo Nv 14 Pi. Trascueto
Telf.- 607 60 59 01

Segovia
40003 Segovia
Tomás Cuéllar Pérez
C/ San Gabriel, 15
921 43 64 65

Sevilla
41008 Sevilla
Electricidad Jar Sevilla, S.L.
Pol. Ind. Store C/ Escarpia Bloque 7 Nave 42
Telf.- 954 35 40 16

Tarragona
43202 Reus
Talleres Capdevila, S.L.
C/ Francés Bartrina, 17
Telf.- 977 31 67 21

Tarragona
43800 Valls
Bobinatges Josep Guxens S.L.
C/ Licoristes, 51 Pol. Ind. Valls
Telf.- 977 61 44 88

Teruel
44001 Teruel
C.b. Talleres Mundo
C/ Yagüe de Salas, 4
Telf.- 978 60 10 54

Toledo
45006 Toledo
Cesar Sánchez Pérez
Pso. De la Rosa, 6-A Local 2
Telf.- 925 25 64 18

Valencia
46009 Valencia
Comercial Mecre - Ricardo José Rojas Argudo
C/ Alfambra 12
Telf.- 96 311 15 57

Valencia
46115 Alfara del Patriarca
Servialfara Siu
Avda. 1º de Mayo 16, Bajo
Telf.- 96 130 95 46

Valencia
46960 Aldaya
Daniel García E Hijos, S.L.
Pol. Ind. Bº Del Cristo C/ Solidaridad 17
Telf.- 961 54 88 30

Valladolid
47011 Valladolid
Salmacar Cb
C/ De los Templarios, 6
Telf.- 983 39 96 21

Vizcaya
48013 Bilbao
Talleres Faever, S.L.
Estrada Zalvidea 13, 2ª A Planta Modulo 5
Telf.- 94 441 25 26

Vizcaya
48903 Baracaldo
Electromecánica Etorri - Etorri, Koop. Elk. Txikia.
Pol. Ind. Kareaga, C/ Retuerto 53
Telf.- 94 433 87 75

Zamora
49016 Zamora
Electricidad Viluz 94 S.L.
Avda. Portugal, 13
Telf.- 980 53 66 21

Zaragoza
50004 Zaragoza
Reparaciones Roncal Sc
C/ Aljafería, 16
Telf.- 976 44 51 56 Zamora

Zaragoza
50010 Zaragoza
Aristel Electric 3000 S.L.
C/ Don Pedro de Luna 84, Local
Telf.- 650 08 20 12

Melilla
52006 Melilla
Tc Melilla Maquinaria, S.L.
C/ De la Hortensia 10 Nv. D-20
Telf.- 952 67 87 50



Andorra
Encamp
Mauco S.A.
Urbanit Prat De Salt / Edf. Mauco
Telf.- 00 376 821 557

Andorra
Andorra La Vella
Mavid, S.A.
Cs 110 Edifici Codi Aixovall Planta 1ª Local 3
Telf.- 00 376 741 010





Catálogo de
ACCESORIOS
2023 / 24



C/ Juan de la Cierva, 7-15
28823 Coslada (Madrid) España
Telf: (34) 91 671 12 62 Fax: (34) 91 671 82 93



www.makita.es

CAMPOMAR
SUMINISTROS, S.L.

www.campomar.com.es

POLIG. LA VEGA | 947591055
AVD. BURGOS, 57 | info@campomar.com.es
09240 BRIVIESCA (Burgos) | facturacion@campomar.com.es